



CH3126 CHASSIS PARTS BOOK

Part #91245

HSMFG070821

Rev. #01

Starting Ser. #221CH32601

STRONG HERITAGE - STRONG PEOPLE - STRONGER FUTURE

CONTENTS

Instructions for Ordering Parts - About Improvements	1
Figure 1 - Main Frame & Components.	2-3
Figure 2 - Tandem Beam & Components	4-5
Figure 3 - Tire & Wheel Package TWP42510S	6-7
Figure 4 - Tire & Wheel Package TWP480S	8-9
Figure 5 - Tire & Wheel Package TWP600S	10-11
Figure 6 - Optional Hitch CHOSCH	12-13
Figure 7 - Optional Hitch HTCHB	14-15
Figure 8 - Spacer Kit	16-17
Figure 9 - Optional Scale System CHO8SCL	18-21
Figure 10 - Optional Brake System CHOBRK	22-27
Parts Notes	28

INSTRUCTIONS FOR ORDERING PARTS

All service parts should be ordered through your authorized H&S dealer. He will be able to give you faster service if you will provide them with the following:

1. Model & Serial Number - Both can be located on the center of the main front plate.
2. All references to left or right apply to the machine as viewed from the rear.
3. Parts should not be ordered from illustration only. Please order complete part number.
4. If your dealer has to order parts - give shipping instructions:

VIA truck - large pieces (please specify local truck lines)

VIA United Parcel Service (include full address)

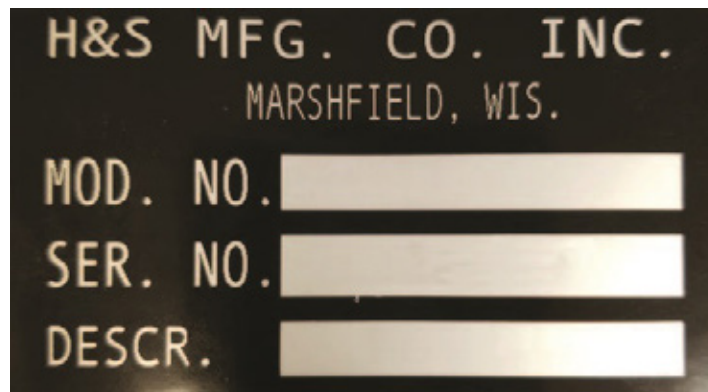

H&S MFG. CO. INC.
MARSHFIELD, WIS.

MOD. NO.

SER. NO.

DESCR.

PLEASE RECORD NUMBERS FOR YOUR UNIT FOR QUICK REFERENCE

ABOUT IMPROVEMENTS

H&S IS CONTINUALLY STRIVING TO IMPROVE ITS PRODUCTS

We must, therefore, reserve the right to make improvements or changes whenever it becomes practical to do so, without incurring any obligation to make changes or additions to the equipment previously sold.

FIGURE 1
MAIN FRAME & COMPONENTS

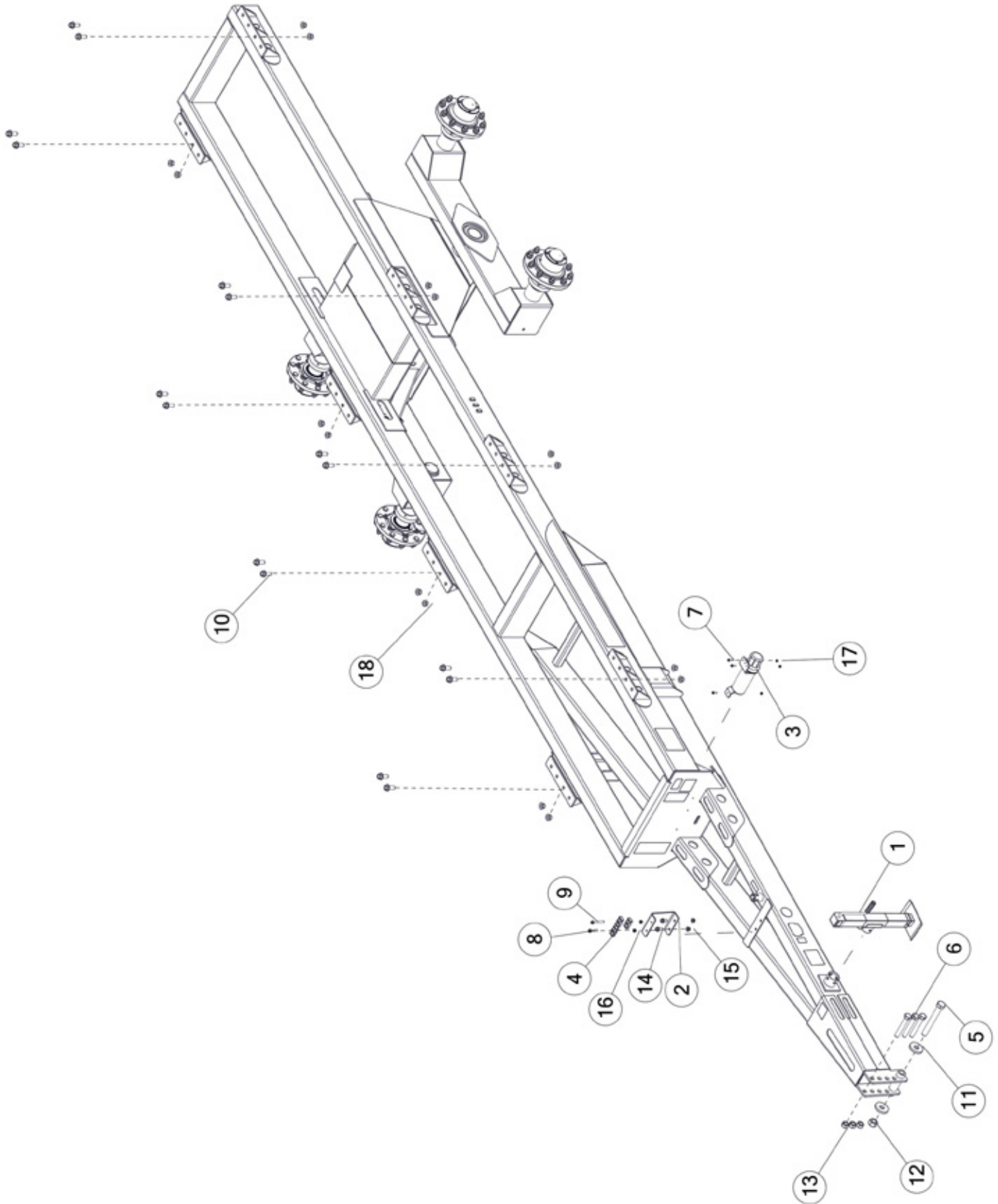

FIGURE 1

MAIN FRAME & COMPONENTS

<u>ITEM</u>	<u>QTY</u>	<u>PART#</u>	<u>DESCRIPTION</u>
1	1	TS306	7000 LB SQUARE JACK 15" TRAVEL
2	1	91169	BRACKET, HYD HOSE
3	1	S522	MANUAL HOLDER
4	4	86567	DOUBLE CLAMP, UNIVERSAL
5	1	YBHH40010	BOLT HEX, 1-1/4 X 10 G5
6	3	YBHH32028	BOLT HEX, 1-8 X 6-1/2 G8 ZY
7	3	YBFB08100	BOLT FLANGE, 1/4 X 1 G5
8	1	YBFB12225	BOLT FLANGE, 3/8 X 2-1/4 G5
9	1	YBFB12350	BOLT FLANGE, 3/8 X 3-1/2 G5
10	16	YBFB24200	BOLT FLANGE, 3/4 X 2 G5
11	2	88825	WASHER FLAT, 1-1/4
12	1	YNHX36010	NUT HEX, 1-1/4-7 NAA ZC
13	3	YNL32005	NUT HEX, 1-8 LKTL C ZC
14	2	YBFB16125	BOLT FLANGE, 1/2 X 1-1/4 G5
15	2	YNFG16003	NUT FLANGE, 1/2 GF
16	2	YNFG12006	NUT FLANGE, 3/8 GF
17	3	YNFG08010	NUT FLANGE, 1/4 GF
18	16	YNFG24006	NUT FLANGE, 3/4-10 LKTL G ZC
*	1	SC60000	SAFETY CHAIN, OPTIONAL

FIGURE 2 **TANDEM BEAM & COMPONENTS**

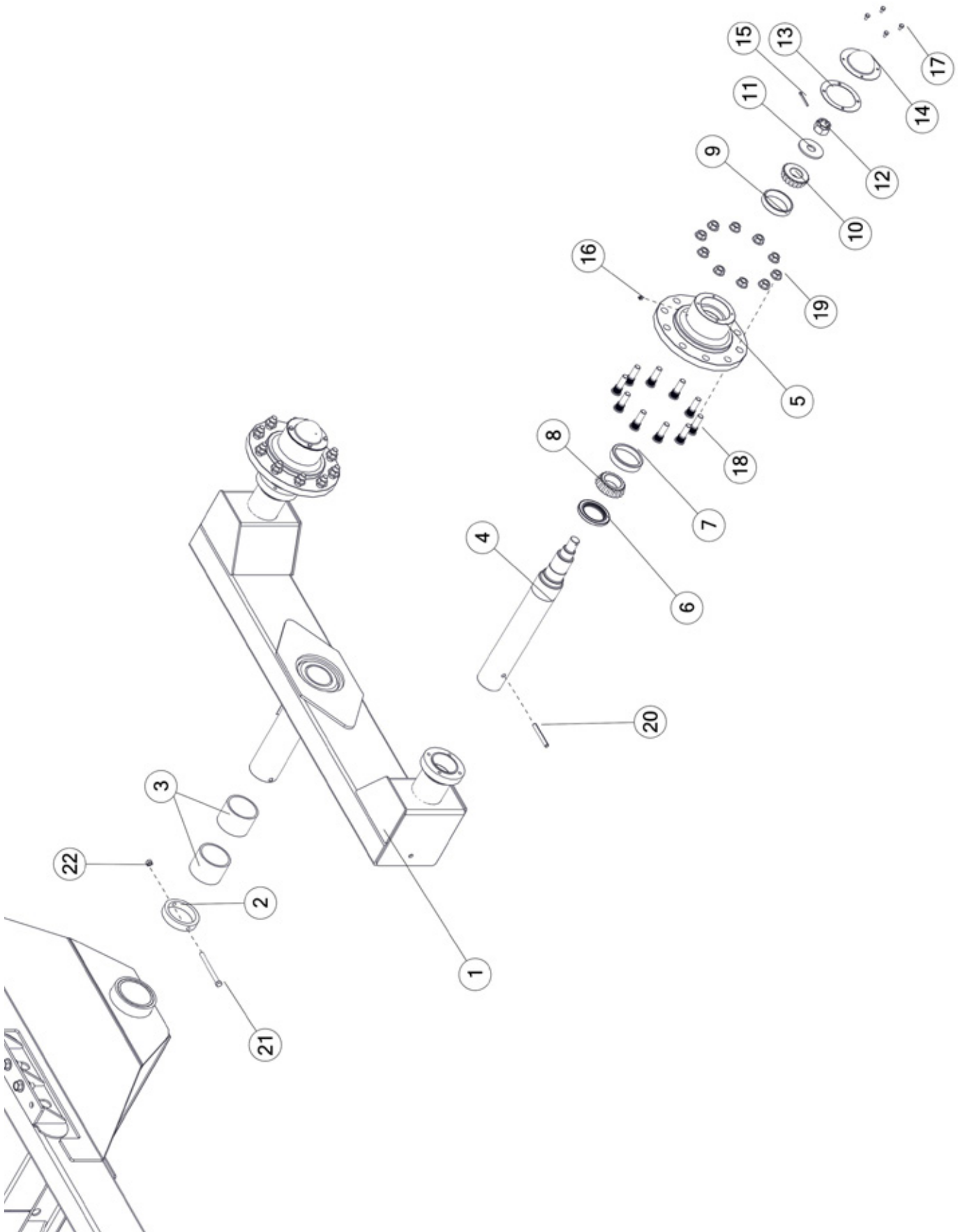

FIGURE 2

TANDEM BEAM & COMPONENTS

<u>ITEM</u>	<u>QTY</u>	<u>PART#</u>	<u>DESCRIPTION</u>
1	1	86159	TANDEM BEAM LONG, LH
*	1	86170	TANDEM BEAM LONG, RH
2	2	16SV214	AXLE MOUNT COLLAR
3	4	70157	BUSHING, NYLATRON, 4-1/2 OD X 4 ID X 3-1/4
4	4	86217	SPINDLE
5	4	54507	871 HUB W/RACES
6	4	60N5	GREASE SEAL
7	4	54504	INNER RACE (KOYO 39520)
8	4	54505	TAPERED ROLLER BEARING, 2.495 BORE
9	4	54503	OUTER RACE (KOYO 453A)
10	4	54506	TAPERED ROLLER BEARING, 1.75 BORE
11	4	60N2	SPINDLE WASHER
12	4	YNCA36005	NUT CASTLE, 1-1/4-12 NAA NF
13	4	56234	HUB CAP GASKET
14	4	60N11	HUB CAP--600 BUSHEL
15	4	YPCT07005	COTTER PIN, 7/32 X 2
16	4	BFR28	GREASE ZERK, 1/8 NPT
17	16	YBHH10020	BOLT HEX, 5/16 X 1/2 G5
18	40	YBSD24010	BOLT STUD, 3/4 X 2-3/4 G8
19	40	YNWL24005	NUT WHEEL, FLANGE, 3/4-16 NA G8 ZY
20	4	YPEX16020	EXPANSION PIN, 1/2 X 4
21	2	YBHH16165	BOLT HEX, 1/2 X 6 G5
22	2	YNL16005	NUT HEX, 1/2

FIGURE 3
TIRE & WHEEL PACKAGE TWP42510S

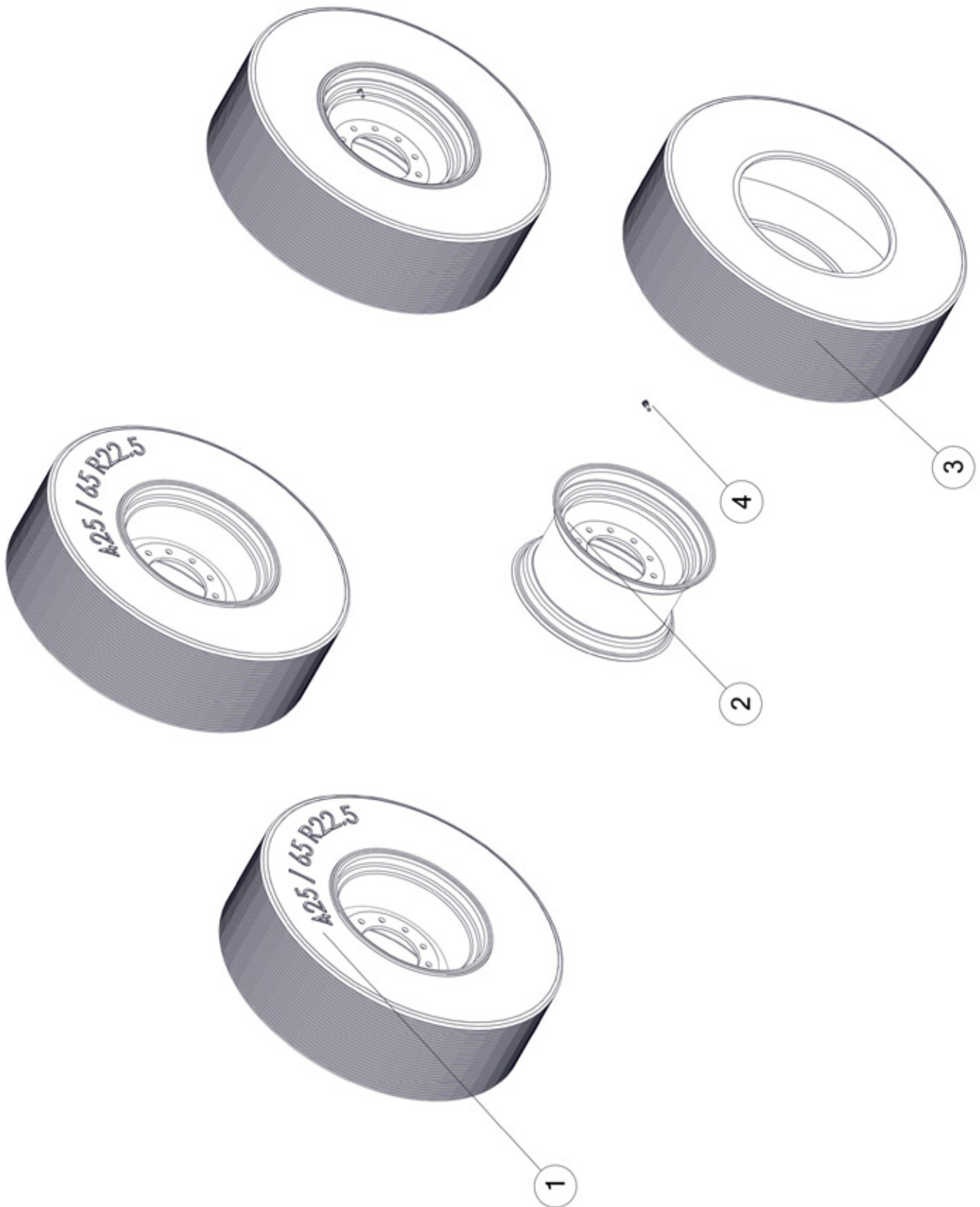

FIGURE 3
TIRE & WHEEL PACKAGE TWP42510S

<u>ITEM</u>	<u>QTY</u>	<u>PART#</u>	<u>DESCRIPTION</u>
1	4	90195	ASSEMBLY, TIRE AND WHEEL
2	4	90188	WHEEL, 22.5 X 13.0 10 BOLT SILVER
3	4	16SV88	TIRE, 425-65 X 22.5
4	4	72438	VALVE STEM, 1-1/2 HEX NUT
*	1	TWP42510S	(4) 425 X 22.5 USED TRUCK TIRES W/ SILVER 10 BOLT RIMS

* NOT SHOWN

FIGURE 4
TIRE & WHEEL PACKAGE TWP480S

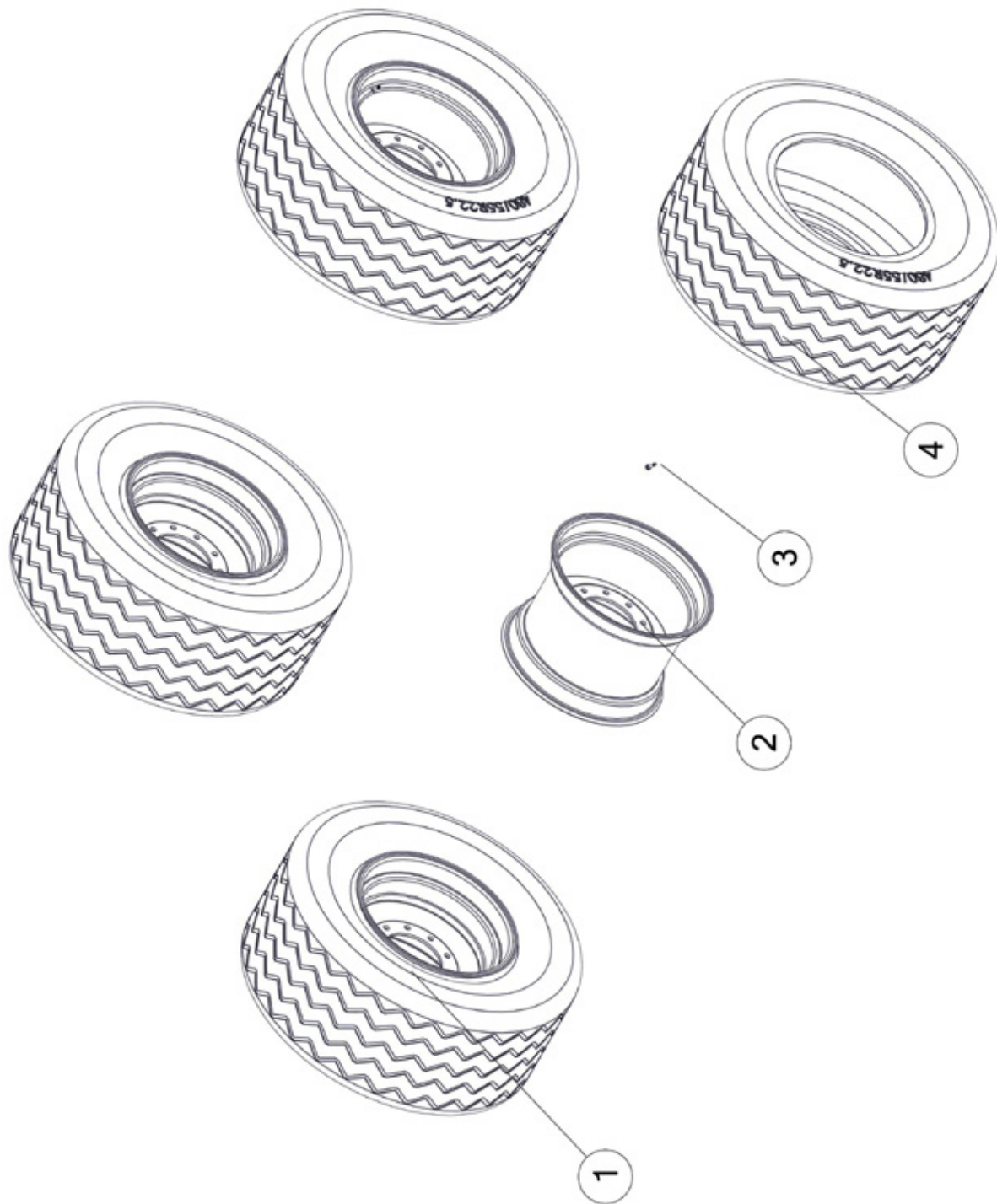

FIGURE 4
TIRE & WHEEL PACKAGE TWP480S

<u>ITEM</u>	<u>QTY</u>	<u>PART#</u>	<u>DESCRIPTION</u>
1	4	90194	ASSEMBLY, TIRE AND WHEEL
2	4	90189	WHEEL, 22.5 X AG16 10 BOLT SILVER
3	4	72436	VALVE STEM, 1-1/2 RUBBER
4	4	77558	TIRE, 480/55R22.5
*	1	TWP480S	(4) 480/55R X 22.5 TIRES W/ SILVER 10 BOLT RIMS

* NOT SHOWN

FIGURE 5
TIRE & WHEEL PACKAGE TWP600S

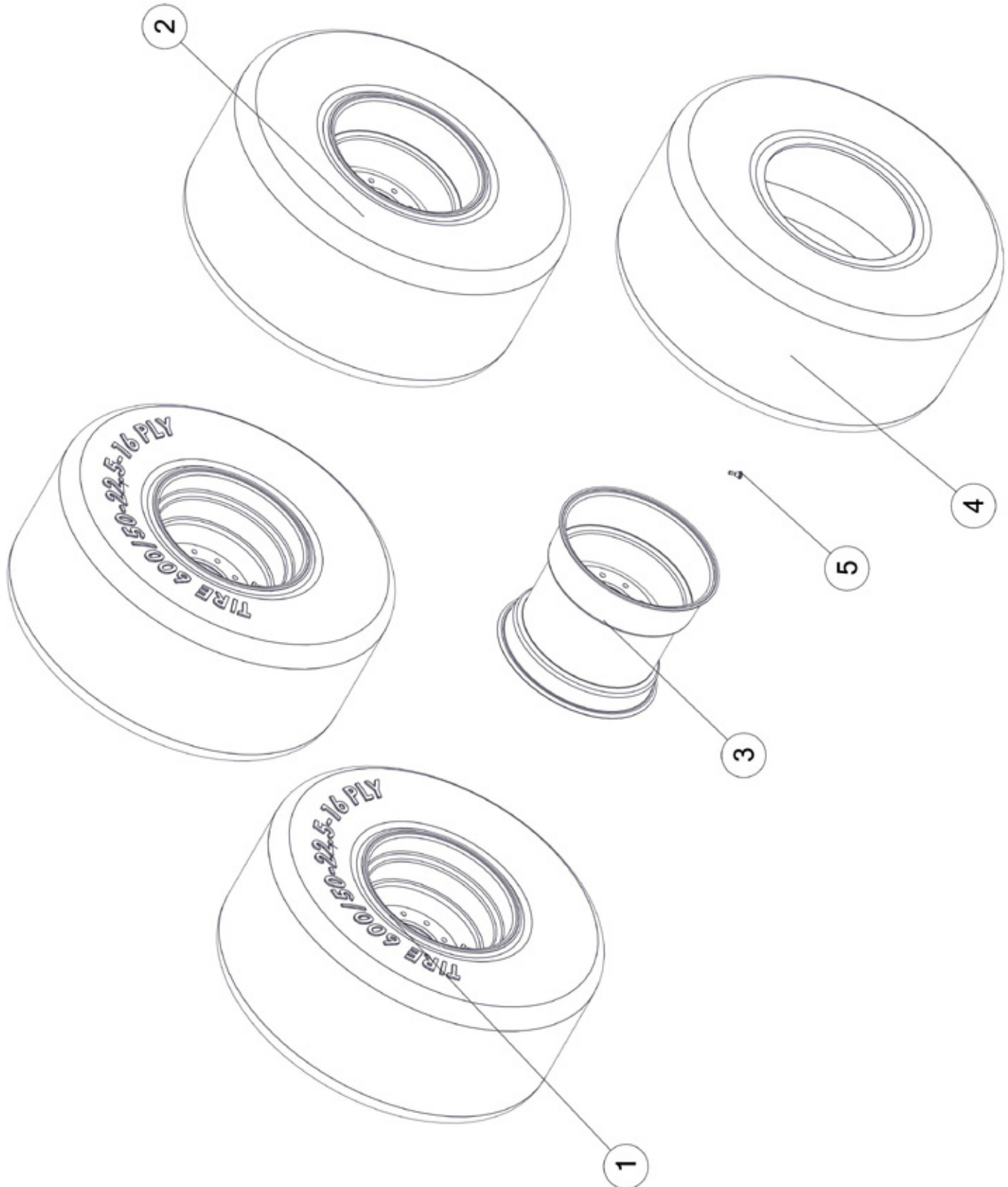

FIGURE 5
TIRE & WHEEL PACKAGE TWP600S

<u>ITEM</u>	<u>QTY</u>	<u>PART#</u>	<u>DESCRIPTION</u>
1	4	90204	ASSEMBLY, TIRE AND WHEEL, RH
2	4	90196	ASSEMBLY, TIRE AND WHEEL, LH
3	4	90190	WHEEL, 22.5 X 20.0 10 BOLT SILVER
4	4	FBC36	TIRE, 600/50-22.5-16 PLY
5	4	72437	VALVE STEM, 1.25 HD
*	1	TWP600S	(4) 600/50 X 22.5 TIRES W/ SILVER 10 BOLT RIMS

* NOT SHOWN

FIGURE 6
OPTIONAL HITCH CHOSCH

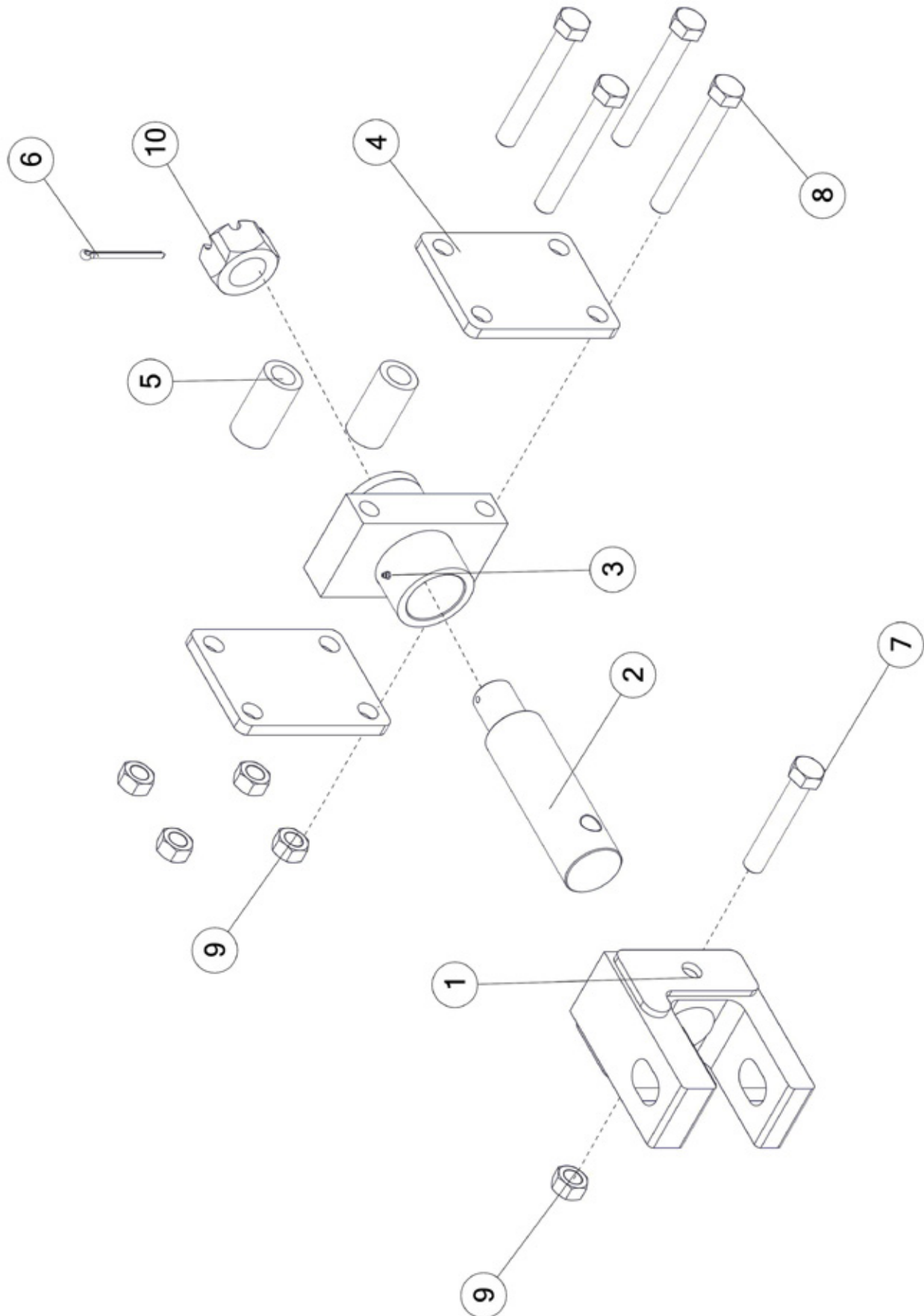

FIGURE 6
OPTIONAL HITCH CHOSCH

<u>ITEM</u>	<u>QTY</u>	<u>PART#</u>	<u>DESCRIPTION</u>
1	1	91293	CLEVIS HITCH, DOUBLE
2	1	91303	SWIVEL HITCH SHAFT
3	1	88691	HITCH PIVOT
4	2	91291	HITCH PLATE
5	2	91294	HITCH CRUSH SLEEVE
6	1	YPCT10020	COTTER PIN, 5/16 X 4
7	1	YBHH32026	BOLT HEX, 1-8 X 6 G8 YELLOW ZINC
8	4	YBHH32034	BOLT HEX, 1-8 X 7-1/2 G8
9	5	YNTL32005	NUT HEX, 1-8 LKTL C ZC
10	1	88698	HITCH PIVOT NUT

FIGURE 7
OPTIONAL HITCH HTCHB

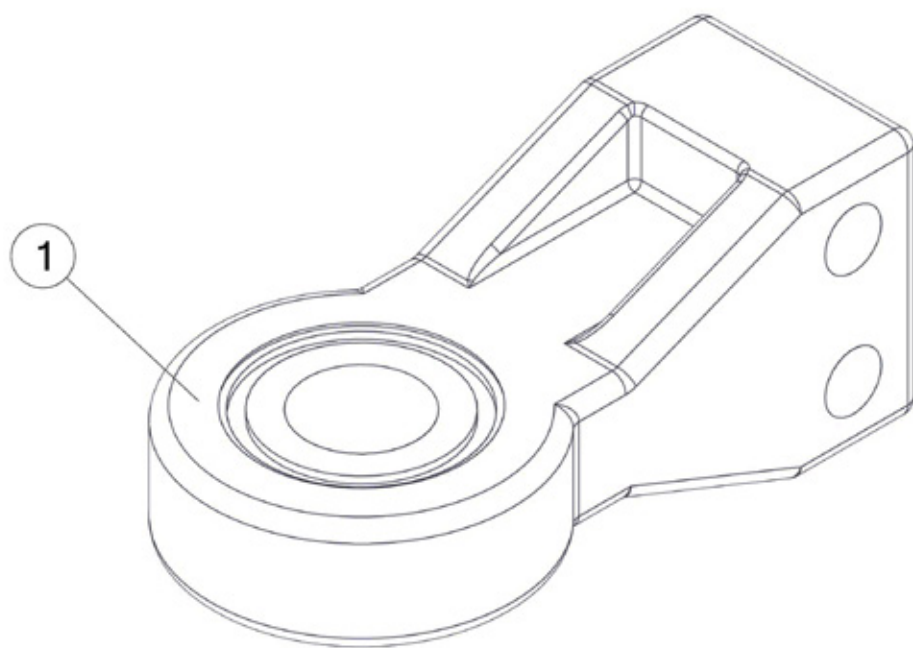

FIGURE 7
OPTIONAL HITCH HTCHB

<u>ITEM</u>	<u>QTY</u>	<u>PART#</u>	<u>DESCRIPTION</u>
1	1	CHHTCHB	HITCH, BULLNOSE

FIGURE 8
SPACER KIT

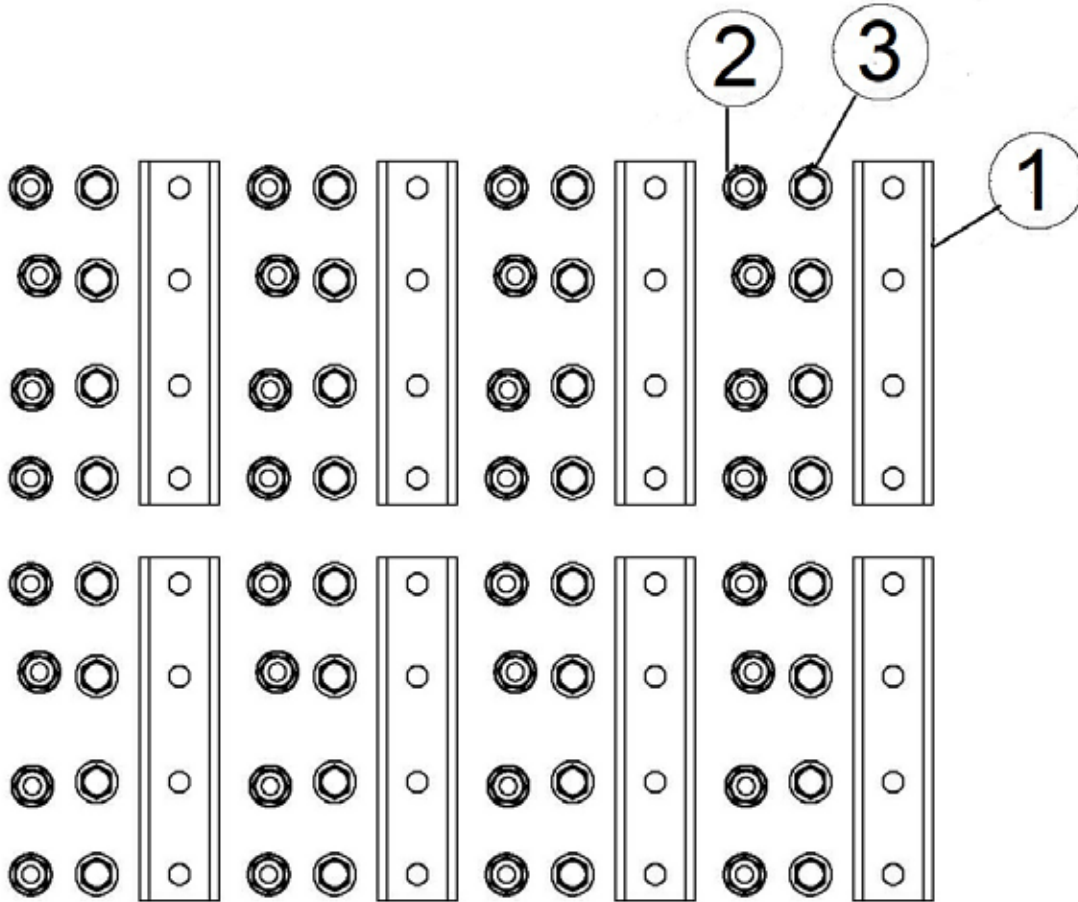

FIGURE 8 SPACER KIT

<u>ITEM</u>	<u>QTY</u>	<u>PART#</u>	<u>DESCRIPTION</u>
1	8	91115	SPACER
2	32	YNFG24006	NUT FLANGE, 3/4-10 LKTL G ZC
3	32	YBFB24400	BOLT FLANGE, 3/4 X 4 G5

FIGURE 9 **OPTIONAL CHO8SCL SCALE SYSTEM**

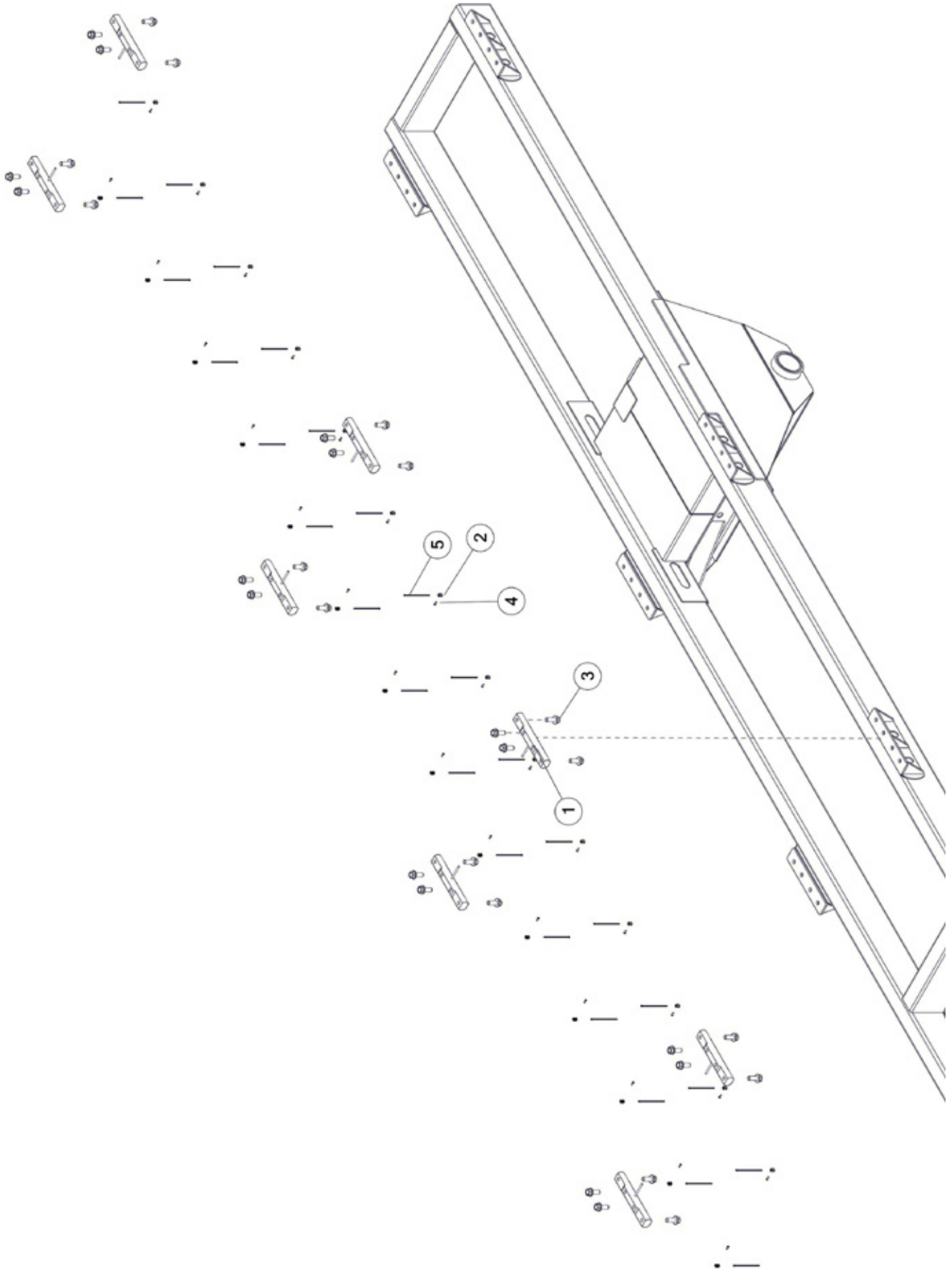

FIGURE 9
OPTIONAL CHO8SCL SCALE SYSTEM

<u>ITEM</u>	<u>QTY</u>	<u>PART#</u>	<u>DESCRIPTION</u>
1	8	90363	LOAD CELL
2	28	71890	CABLE TIE HOLD DOWN
3	32	YBFB24200	BOLT FLANGE, 3/4 X 2 G5
4	28	YSTC64005	THREAD CUTTING SCREW, PAN HEAD, 10-32 X 1/2
5	28	CIZT108	ZIPTIE, 6 X .14 X .05

FIGURE 9 **OPTIONAL CHO8SCL SCALE SYSTEM**

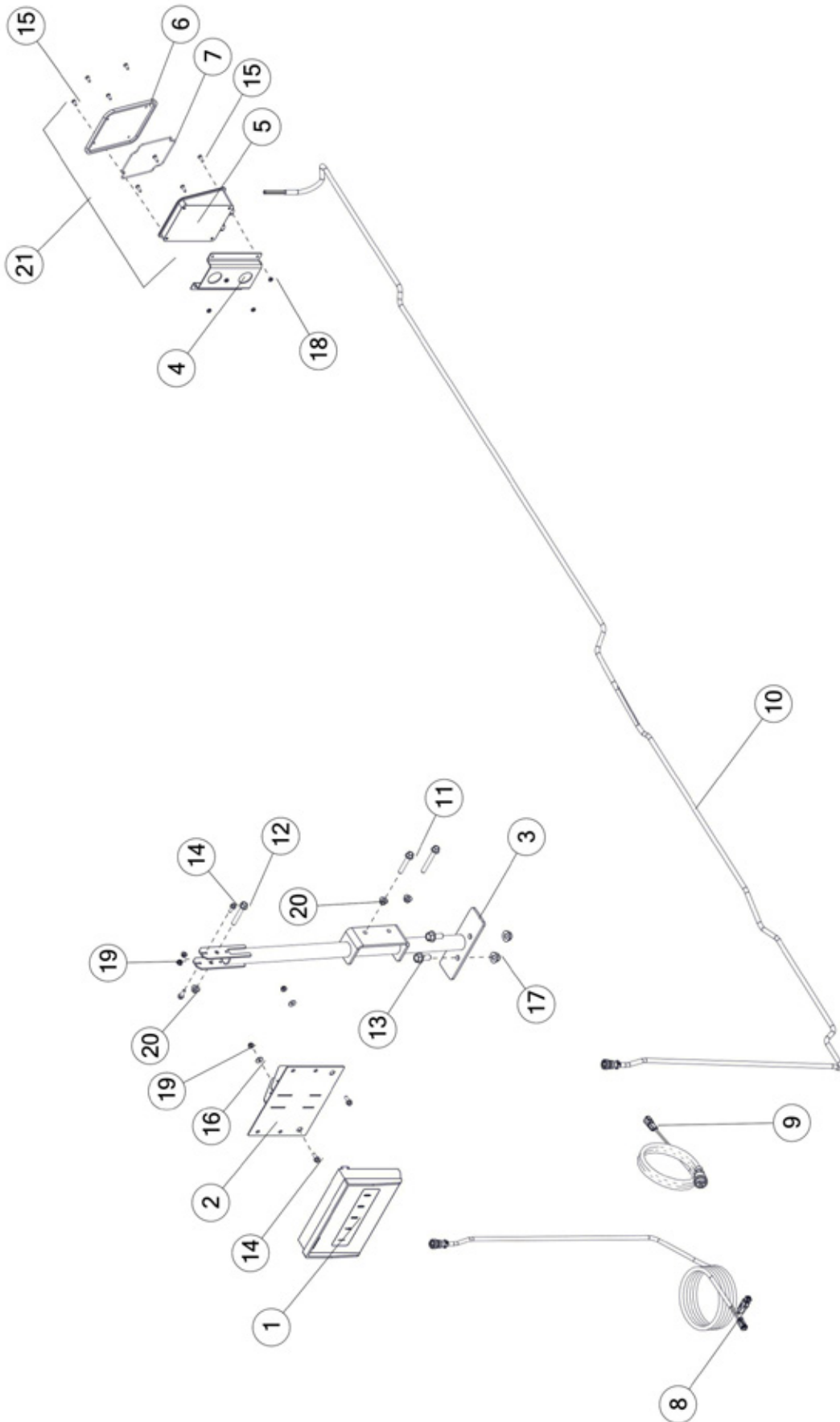

FIGURE 9

OPTIONAL CHO8SCL SCALE SYSTEM

<u>ITEM</u>	<u>QTY</u>	<u>PART#</u>	<u>DESCRIPTION</u>
1	1	GM404	SCALE MONITOR
2	1	92335	MOUNT, SCALE HEAD
3	1	92336	BRACKET, SCALE HEAD
4	1	71840	BRKT, J BOX MOUNT
5	1	71904	HSG J-BOX BOTTOM 6-8 CELL
6	1	71911	HSG-J BOX TOP
7	1	71909	GASKET, J-BOX HOUSING
8	1	92356	ELECTRIC HARNESS, SCALE
9	1	59107	POWER CABLE
10	1	GM406	JUNCTION BOX CORD
11	2	YBFB12225	BOLT FLG, 3/8 X 2-1/4 G5
12	1	YBFB12250	BOLT FLANGE, 3/8 X 2-1/2 G5
13	2	YBFB16125	BOLT FLANGE, 1/2 X 1-1/4 G5
14	4	YBFB08075	BOLT FLANGE, 1/4 X 3/4 G5
15	8	YSPN64005	SCREW PAN HEAD, #10-24 X 5/8
16	2	YWFL08005	WASHER FLAT, 1/4
17	2	YNFG16003	NUT FLANGE, 1/2 GF
18	4	YNHX64010	NUT HEX, MACHINE, #10-24, ZC
19	4	YNFG08010	NUT FLANGE, 1/4 GF
20	3	YNFG12006	NUT FLANGE, 3/8 GF
21	1	71914	CELL MODULE ASSY, J-BOX 6-8

FIGURE 10
OPTIONAL CHOBK BRKE SYSTEM

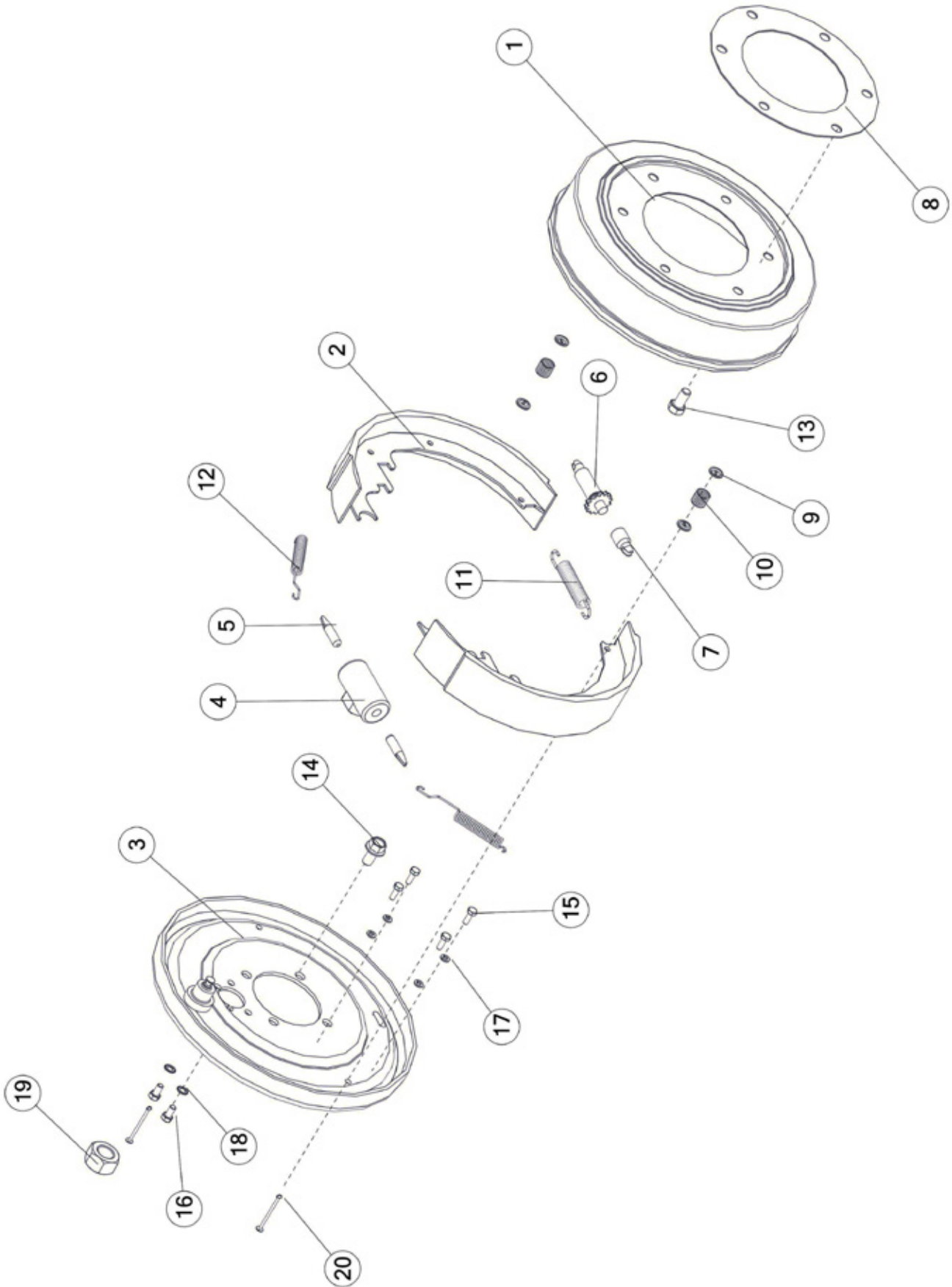

FIGURE 10

OPTIONAL CHOBRK BRAKE SYSTEM

<u>ITEM</u>	<u>QTY</u>	<u>PART#</u>	<u>DESCRIPTION</u>
1	1	RGE10	BRAKE DRUM FOR 20 TON RG
2	2	FBC50	REAR BRAKE SHOE ASSEMBLY
3	1	74293	ASSY, BACKING PLATE, 20 TON
4	1	74292	MASTER BRAKES, 20 TON
5	2	FBC54	PUSH ROD
6	1	74289	ADJUSTING SCREW
7	1	74290	BRAKE ADJUSTER SOCKET
8	1	CB20	DRUM SPACER
9	4	RGB57	CUP SHOE HOLD DOWN
10	2	RGB59	SPRING HOLD DOWN
11	1	RGB50	SPRING ADJUSTING SCREW
12	2	RGB55	SPRING SHOE
13	6	YBHH16011	BOLT HEX, 1/2 X 1 G5
14	4	YBFB16100	BOLT FLG, 1/2 X 1 G5
15	4	YBHH08100	BOLT HEX, 1/4 X 3/4 G5
16	2	YBHH10132	BOLT HEX, 5/16 X 5/8 G5
17	4	YWLO08005	WASHER LOCK, 1/4
18	2	YWSI10005	WASHER LOCK, STAR, 5/16
19	1	YNHX32011	NUT HEX, 1 G5
20	2	RGB56	PIN-SHOE HOLD DOWN

FIGURE 10
OPTIONAL CHOBK BRKE SYSTEM

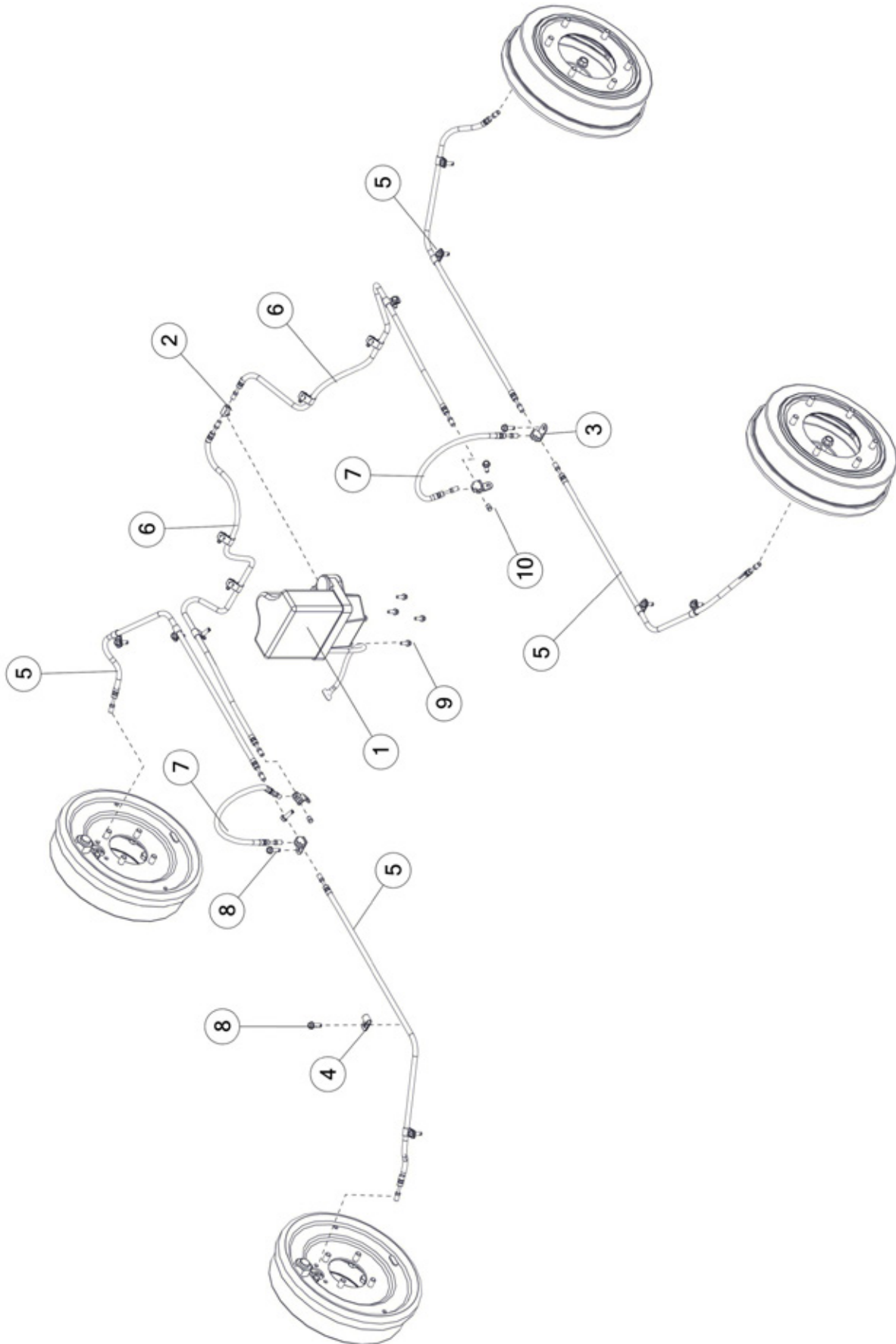

FIGURE 10
OPTIONAL CHOBK BRAKE SYSTEM

<u>ITEM</u>	<u>QTY</u>	<u>PART#</u>	<u>DESCRIPTION</u>
1	1	FBC41	PUMP/MASTER CYLINDER
2	1	FBC45	BRANCH TEE
3	4	RGB26	BRAKE LINE TEE
4	14	HGV162	RUBBER WIRE HOLDER, 1/2
5	4	92419	BRAKE HOSE, 36
6	2	92467	BRAKE HOSE, 48
7	2	FBC46	HYDRAULIC BRAKE HOSE
8	18	YSST10005	BOLT FLANGE, SELF THREADING, .312 X 1
9	4	YBFB08075	BOLT FLANGE, 1/4 X 3/4 G5
10	2	57176	BRAKE LINE PLUG, 3/16

FIGURE 10
OPTIONAL CHOBKR BRAKE SYSTEM

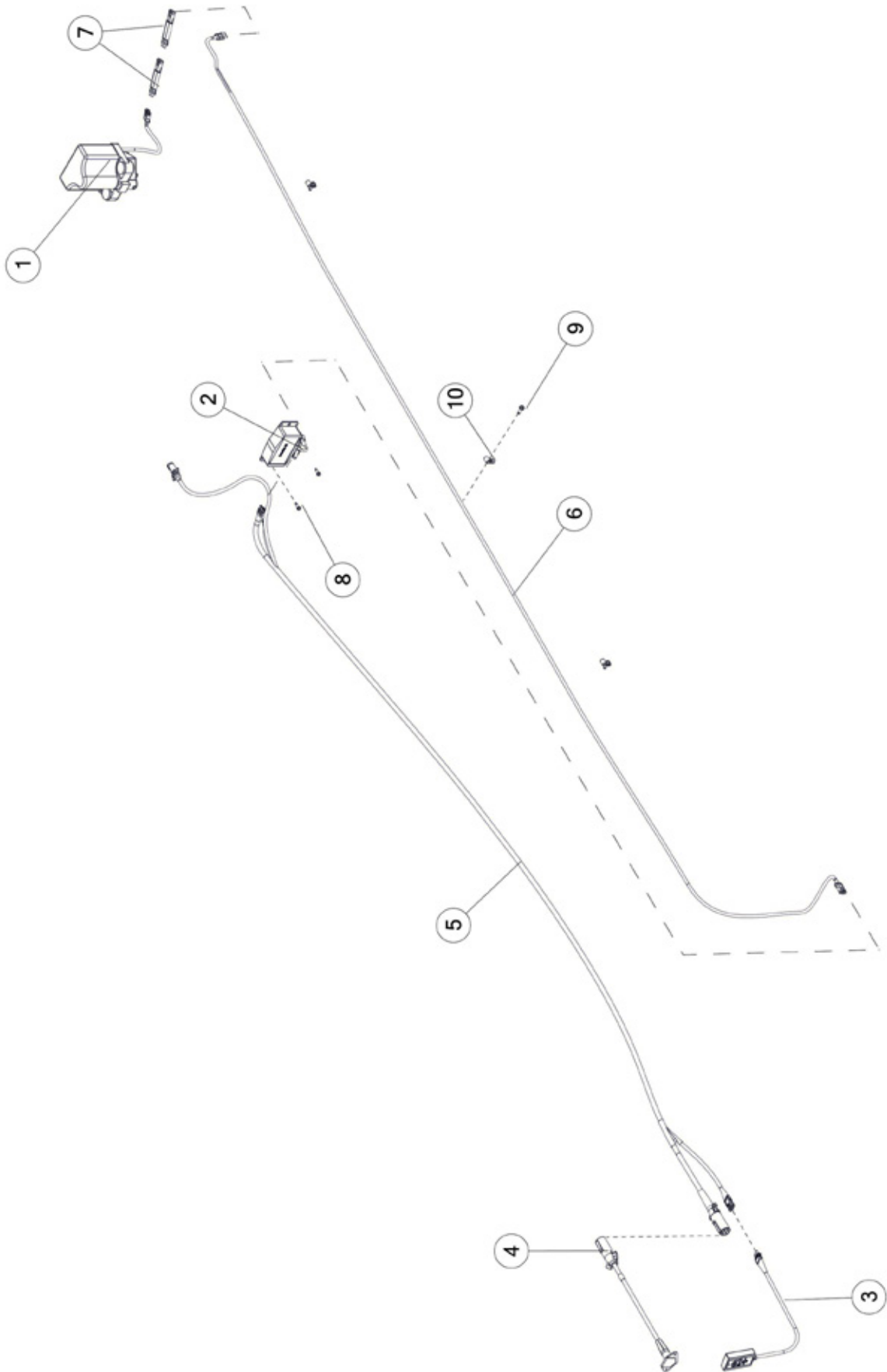

FIGURE 10
OPTIONAL CHOBK BRAKE SYSTEM

<u>ITEM</u>	<u>QTY</u>	<u>PART#</u>	<u>DESCRIPTION</u>
1	1	FBC41	PUMP/MASTER CYLINDER
2	1	FBC39	BRAKE CONTROL MODULE
3	1	FBC38	BRAKE CONTROL
4	1	92492	ELECTRIC HARNESS, 4 FEMALE-7 MALE
5	1	FBC30	ELECTRIC BRAKE HARNESS
6	1	FBC40	PUMP/MASTER CYLINDER HARNESS
7	2	73990	ELEC, BRAKE RESISTOR
8	2	YSDR08005	SCREW SELF DRILLING, HEX WASHER HEAD, 1/4 X 1
9	4	YSST10005	BOLT FLANGE, SELF THREADING, .312 X 1
10	4	HGV162	RUBBER WIRE HOLDER, 1/2

CHANGE NOTES

H&S MFG. CO.

products approved

for the

FEMA

SEAL OF QUALITY



Manufactured by:

H&S MANUFACTURING CO., INC.

2608 S. HUME AVE. MARSHFIELD, WI 54449

(715) 387-3414 | hsmfgco.com

