



310/370/430 MANURE SPREADER

OPERATOR'S MANUAL



WARNING

**READ AND UNDERSTAND THIS MANUAL
BEFORE OPERATING THIS EQUIPMENT.
UNSAFE OPERATION OR MAINTENANCE OF
THIS EQUIPMENT CAN RESULT IN SERIOUS
INJURY OR DEATH.**

Revision #1

310 Starting Serial #315300

370 Starting Serial #316296

430 Starting Serial #319420

HSMFG1012

Part #59681

Manufactured By
H&S MANUFACTURING CO., INC.

P.O. BOX 768 (715) 387-3414 FAX (715) 384-5463
MARSHFIELD, WISCONSIN 54449

CONTENTS

Warranty & Warranty Registration Card	1-2
Manufacturers Statement	2
Dealer Pre-Delivery Checklist	3-4
Dealer Delivery Checklist	5-6
Safety Information - Be Alert Symbol	7
Safety Information - Explanation of Safety Signs	8
Safety Decals	9-10
Safety Information - Warning - Owner Must Read and Understand	11
Cap Screw Torque Values	12
Set-Up & Assembly	13
Transporting	13
Preparing for Operation	14
Operation	15-16
Adjustments	17-18
Service	19
Optional Equipment	20-21
Lubrication Guide	22-23
Trouble Shooting	24
Decal Location	25-27
Service Notes	28
Specifications	Inside Back Cover

WARRANTY

H&S WARRANTY

H&S Manufacturing Co., Inc. ("H&S") warrants this product to be free from defect in material and workmanship. Except as noted below, this warranty term is twelve (12) months from the date of delivery of the product to the original purchaser by an authorized H&S dealer. Under this warranty, H&S will repair or replace, at its option, any covered part which is found to be defective in material or workmanship during the applicable warranty term. In no case will the covered repair cost of a part or parts exceed the replacement cost of that part. Warranty service must be performed by H&S or a dealer authorized by H&S to sell and/or service the product involved, which will use only new or remanufactured parts or components furnished by H&S. This warranty includes approved parts and labor to fix the product but does not include, and the purchaser is responsible for, any service call and/or transportation of the product to and from the dealer's place of business, for any premium charged for overtime labor requested by the purchaser, and for any service work not directly related to any defect covered under this warranty. This warranty includes only those components of the product manufactured by H&S. Warranty for any component not manufactured by H&S including, but not limited to, engines, batteries, tires, rims, hydraulic motors, pumps, etc. are covered by the warranty, if any, provided separately by their respective manufacturers.

This warranty in all its parts, is extended solely to the original purchaser of the product, is terminated upon any subsequent transfer or sale from or by the original purchaser and extends no third party benefits or rights whatsoever.

The warranty term for any product used in any commercial, custom, for hire or rental application, is limited to six (6) months from the date of delivery of the product to the original purchaser or the first day of service, whichever comes first, by an authorized H&S dealer.

Floor and side panels utilized in H&S Manure Spreaders are warranted, to the original purchaser, to not wear through or delaminate for 10 years when used to spread normal agricultural manure. The frame, sides, end, floor and roof of forage boxes are warranted to not wear or rust through for 10 years when the forage box is used to transport freshly chopped forage. These specific warranties include only replacement of any defective panel part without any allowance for labor beyond the terms of the standard H&S 12 month warranty.

For commercial, custom for hire, or rental application, warranty is limited to 6 months from the date of delivery to the original purchaser, or the first day in service, whichever is earlier.

This warranty does not include: (1) Any product that has been altered or modified in ways not approved by H&S; (2) Depreciation or damage caused by normal wear, misuse, improper or insufficient maintenance, improper operation, accident or failure to follow the product Operator's Manual recommendations and product decal recommendations; (3) Normal maintenance parts and service; (4) Repairs made with parts other than those available from H&S or performed by anyone other than H&S or a dealer authorized by H&S to sell and/or service the product involved.

To secure warranty service the purchaser must report the product defect to a dealer authorized by H&S to sell and/or service the product involved within the applicable warranty term together with evidence of the warranty start date and make the product available to that dealer within a reasonable period of time.

THERE ARE NO WARRANTIES WHICH EXTEND BEYOND THE DESCRIPTION ON THE FACE OF THIS WARRANTY. H&S and the companies affiliated with it makes no warranties, representations, or promises, express or implied, as to the performance or freedom from defect of its products other than those set forth above and **NO IMPLIED WARRANTY OF MERCHANTABILITY, FITNESS OR FITNESS FOR A PARTICULAR PURPOSE IS MADE. IN NO EVENT WILL THE DEALER, H&S OR ANY COMPANY AFFILIATED WITH H&S BE LIABLE FOR INCIDENTAL OR CONSEQUENTIAL DAMAGES.** The **ONLY REMEDY** the purchaser has in connection with the breach of performance of any warranty on H&S products are those set forth above.

The selling dealer has no authority to make any representation or promise on behalf of H&S, or to modify the terms or limitations of this warranty in any way.

12/13

**FILL OUT
AND MAIL
IMMEDIATELY
TO MAKE
WARRANTY
EFFECTIVE**



WARRANTY REGISTRATION

Date of Purchase _____

Purchaser _____ Address _____

City _____ State _____ Zip _____

Product _____ Model# _____ Serial# _____

Dealer _____ Address _____

City _____ State _____ Zip _____

Signature of Original Buyer

MANUFACTURER'S STATEMENT

Your New H&S Product has been manufactured of the finest quality materials and components. The performance you get from your machine is largely dependent upon how well you read and understand this manual and apply this knowledge. There is a right and a wrong way to do everything. Please do not assume that you know how to operate and maintain your Machine before reading this manual carefully. Keep this manual available for ready reference.

IMPORTANT!

Tear on the dotted line, provide the information requested on the card. The H&S Warranty is valid "only" after this card is received and recorded at H&S Manufacturing Co., Inc. Mail at once. No postage is required in the U.S.A.



NO POSTAGE
NECESSARY
IF MAILED
IN THE
UNITED STATES

BUSINESS REPLY MAIL

FIRST CLASS MAIL Permit No.195 Marshfield, WI 54449

POSTAGE WILL BE PAID BY ADDRESSEE

H&S Manufacturing Co., Inc.
PO Box 768
Marshfield, WI 54449-9963



H&S DEALER PRE-DELIVERY CHECK LIST

AFTER COMPLETION, DEALER SHOULD REMOVE AND RETAIN FOR RECORDS

After the Manure Spreader has been completely set-up, check to be certain it is in correct operating order before delivering to the customer. The following is a list of points to inspect. Check off each item as you have made the proper adjustments and found the item operating satisfactorily.

- Manure Spreader was not damaged in shipment. Check for dents and loose or missing parts. Report damage immediately to H&S Manufacturing Co., Inc.
- Manure Spreader has been correctly assembled according to instructions in this manual.
- All bolts and fasteners are tight.
- All shields and guards are in place and secured.
- All grease fittings have been lubricated. Gearbox is filled to proper levels. See Lubrication Chapter of this manual for details.
- Hoses and fittings if applicable, are properly attached and there are no visible leaks.
- All drive chains are adjusted to proper tension. See Adjustment Chapter of this manual.
- Decals are in place and legible.
- Connect the Manure Spreader to a tractor and attach the PTO and make sure that the PTO guards turns freely.
- Connect the lights to the tractor if applicable. Lights and wiring functioning properly.
- Run the Manure Spreader and make sure all components operate properly.
- Hydraulic system if applicable, does not leak under pressure.

Model Number _____

Serial Number _____

Dealer's Name _____

Inspection Date _____

Signature of Pre-Delivery Inspector _____

(Remove Dealer File Copy At Perforation)

Intentionally Left Blank

DEALER DELIVERY CHECK LIST

AFTER COMPLETION, DEALER SHOULD REMOVE AND RETAIN FOR RECORDS

This check list that follows is an important reminder of valuable information that should be passed on to the customer at the time this Manure Spreader is delivered.

Check off each item as you explain it to the customer.

This delivery check list, when properly filled out and signed assures the customer that the pre-delivery service was satisfactorily performed.

- Explain to the customer that the pre-delivery inspection was made.
- Explain to the customer all the safety precautions they must exercise when operating this unit.
- Explain recommended loads for different types of materials.
- Explain to customer that regular lubrication is required for proper operation and long life of machine.
- Show customer the lubrication section of Owner's Manual.
- Give the customer Owner's Manual and make sure they read and understand all operating and service instructions.
- Have customer sign a completed "Warranty Registration," and mail it promptly.

Date Delivered _____

Dealer's Name _____

By _____

Signature of Original Buyer _____

Note: Warranty is not valid until warranty card is completed and returned to H&S Mfg. Co., Inc.

Intentionally Left Blank

SAFETY INFORMATION



**BE
ALERT!**

**YOUR SAFETY
IS INVOLVED.**

THIS SYMBOL IS USED THROUGHOUT THIS BOOK WHENEVER YOUR PERSONAL SAFETY IS INVOLVED. TAKE TIME TO BE CAREFUL. REMEMBER: THE CAREFUL OPERATOR IS THE BEST OPERATOR. MOST ACCIDENTS ARE CAUSED BY HUMAN ERROR. CERTAIN PRECAUTIONS MUST BE OBSERVED TO PREVENT THE POSSIBILITY OF INJURY OR DAMAGE.

H&S MANUFACTURING CO., INC.

SAFETY INFORMATION

Keep signs in good condition. Immediately replace any missing or damaged signs.

RECOGNIZE SAFETY INFORMATION

This is the safety-alert symbol. When you see this symbol on your machine or in this manual, be alert to the potential for personal injury.

Follow recommended precautions and safe operating practices.



UNDERSTAND SIGNAL WORDS

A single word; DANGER, WARNING, or CAUTION is used with the safety-alert symbol. DANGER identifies the most serious hazards.

Safety signs with signal word DANGER or WARNING are typically near specific hazards.

General precautions are listed on CAUTION safety signs.



FOLLOW SAFETY INSTRUCTIONS

Carefully read all safety messages in this manual, and all safety signs on your machine. Follow all recommended precautions and safe operating procedures.

OBSERVE MAXIMUM TRANSPORT SPEED

The maximum transport speed for this implement is 32 km/h (20 m.p.h.).

Some tractors are capable of operating at speeds that exceed the maximum transport speed of this implement. Regardless of the maximum speed capability of the tractor being used to tow this implement, do not exceed the implement's maximum transport speed.

Exceeding the implements maximum transport speed can result in:

- * Loss of control of the tractor/implement combination
- * Reduced or no ability to stop during braking
- * Implement tire failure
- * Damage to the implement structure or its components

Use additional caution and reduce speed when towing under adverse surface conditions, when turning, and when on inclines.

Do not attempt transport if the fully loaded implement weighs more than 1.5 times the weight of the tractor.

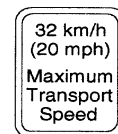

SAFETY INFORMATION

	<div style="background-color: #cccccc; padding: 2px;">⚠ WARNING</div> <p style="text-align: center;">DO NOT OPERATE THIS EQUIPMENT IF THIS DECAL IS EXPOSED. REPLACE SAFETY SHIELDS.</p>
1494A	

⚠ DANGER

<p style="text-align: center;">ROTATING DRIVELINE CONTACT CAN CAUSE DEATH KEEP AWAY!</p> <p style="text-align: center;">DO NOT OPERATE WITHOUT-</p> <ul style="list-style-type: none"> • ALL DRIVELINE, TRACTOR AND EQUIPMENT SHIELDS IN PLACE. • DRIVELINES SECURELY ATTACHED AT BOTH ENDS. • DRIVELINE SHIELDS THAT TURN FREELY ON DRIVELINE.
1494L

	<div style="background-color: #cccccc; padding: 2px;">⚠ WARNING</div> <p style="text-align: center;">DO NOT GO NEAR LEAKS</p> <ul style="list-style-type: none"> • High pressure oil easily punctures skin causing serious injury, gangrene or death. • If injured, seek emergency medical help. Immediate surgery is required to remove oil. • Do not use finger or skin to check for leaks. • Lower load or relieve hydraulic pressure before loosening fittings.
11599	

⚠ WARNING		
		
<p style="text-align: center;">CRUSHING HAZARD</p> <p style="text-align: center; font-size: small;">TO PREVENT SERIOUS INJURY OR DEATH:</p> <p style="font-size: x-small;">KEEP HANDS AND BODY OUT OF HITCH AREA WHEN ATTACHING TOWING VEHICLE.</p> <p style="font-size: x-small;">KEEP BODY CLEAR OF CRUSH POINT BETWEEN TOWING VEHICLE AND LOAD.</p> <p style="font-size: x-small;">KEEP FEET AND LEGS CLEAR FROM UNDER TONGUE AREA IN CASE OF POSSIBLE JACK FAILURE.</p>		
82002		

	<div style="background-color: #cccccc; padding: 2px;">⚠ WARNING</div> <p style="text-align: center;">DO NOT REMOVE SHIELDS ROTATING PARTS INSIDE</p>
12794	

	<div style="background-color: #cccccc; padding: 2px;">⚠ WARNING</div> <p style="text-align: center;">DO NOT OPERATE THIS EQUIPMENT IF THIS DECAL IS EXPOSED. REPLACE SAFETY SHIELDS.</p>
71494A	

SAFETY INFORMATION



⚠ WARNING
DO NOT REMOVE SHIELDS
MOVING PARTS INSIDE



NEVER ALLOW RIDERS ON THIS MACHINE

9194B



DO NOT REMOVE SHIELDS
MOVING PARTS INSIDE

1494K



DO NOT CLEAN OR WORK ON THIS MACHINE WITHOUT FIRST DISENGAGING POWER AND SHUTTING OFF TRACTOR ENGINE.

1494J



⚠ DANGER
STAY CLEAR OF BEATER IF TRACTOR OR PTO IS RUNNING
BEATER SHUT OFF COULD ACCIDENTALLY BE ENGAGED
FAILURE TO HEED THIS WARNING MAY RESULT IN PERSONAL INJURY OR DEATH
KEEP CLOTHING, YOURSELF AND OTHERS WELL CLEAR

SAFETY INFORMATION

TRACTORS:

This operators manual uses the term “Tractor” when identifying the power or the towing source.



TO PREVENT SERIOUS INJURY OR DEATH

BEFORE YOU ATTEMPT TO OPERATE THIS EQUIPMENT, READ AND STUDY THE FOLLOWING INFORMATION. IN ADDITION, MAKE SURE THAT EVERY INDIVIDUAL WHO OPERATES OR WORKS WITH THIS EQUIPMENT, WHETHER FAMILY MEMBER OR EMPLOYEE, IS FAMILIAR WITH THESE SAFETY PRECAUTIONS.

KNOW HOW TO STOP UNLOADING MECHANISM BEFORE STARTING IT.

If the machine becomes clogged, disengage the PTO. Stop the tractor engine, remove ignition key, and allow all mechanisms to stop before cleaning or working on the machine.

DO NOT get off the tractor while the Manure Spreader is in operation.

DO NOT attempt to perform maintenance or repair with tractor running and PTO or hydraulic lines hooked up.

DO NOT step up on machine at any time.

NEVER manually feed material into the beaters.

DO NOT allow minors to operate or be near the machine.

DO NOT ALLOW PERSONNEL OTHER THAN THE QUALIFIED OPERATOR NEAR THE MACHINE.

Before starting tractor, be sure PTO shields turn freely and PTO is securely locked to tractor.

DO NOT clean, adjust, or lubricate the machine when any part is in operation.

Keep hands, feet, and clothing away from beaters when they are revolving.

Loose or floppy clothing should not be worn by the operator.

Be sure the machine is clear of people, tools, and other objects before engaging PTO.

DO NOT step over power take off shaft. Stay clear of PTO at all times.

NEVER start Manure Spreader until all guards and safety shields are secured in place.

STAY CLEAR of Hydraulic Lines. They may be under extreme pressure or heat.

H&S always takes the operator and his safety into consideration and guards exposed moving parts for his protection. However, some areas cannot be guarded or shielded in order to assure proper operation. In addition, the operators manual and decals on the machine itself warn you of further danger and should be read and observed closely.

Study The Above Safety Rules
ATTENTION - BE ALERT - YOUR SAFETY IS INVOLVED

CAP SCREW TORQUE VALUES

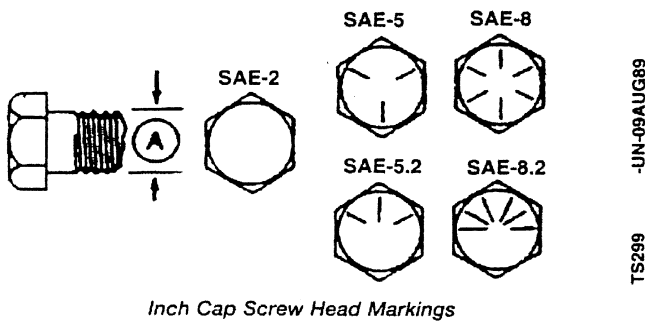

Inch Cap Screw Head Markings

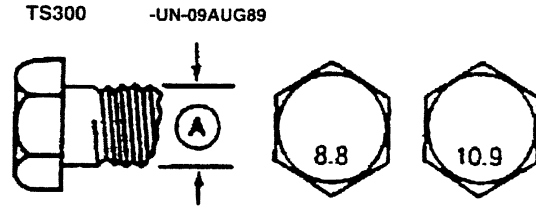

Metric Cap Screw Head Markings

INCH CAP SCREW TORQUE VALUES

METRIC CAP SCREW TORQUE VALUES

Bolt Diameter (A)	Wrench Size	Cap Screw Grade					
		SAE 2		SAE 5		SAE 8	
		N-m	lb.-ft	N-m	lb.-ft	N-m	lb.-ft
1/4"	7/16"	7	(5)	11	(8)	16	(12)
5/16"	1/2"	14	(10)	23	(17)	33	(24)
3/8"	9/16"	24	(18)	41	(30)	54	(40)
7/16"	5/8"	41	(30)	68	(50)	95	(70)
1/2"	3/4"	61	(45)	102	(75)	142	(105)
9/16"	13/16"	88	(65)	142	(105)	203	(150)
5/8"	15/16"	122	(90)	197	(145)	278	(205)
3/4"	1-1/8"	217	(160)	353	(260)	495	(365)
7/8"	1-5/16"	224	(165)	563	(415)	800	(590)
1"	1-1/2"	332	(245)	848	(625)	1193	(880)
1-1/4"	1-7/8"	665	(490)	1492	(1100)	2393	(1765)

Bolt Diameter (A)	Wrench Size	Markings on Cap Screw Heads			
		8.8		10.9	
		N-m	lb.-ft	N-m	lb.-ft
5 mm	8 mm	6	(4.5)	9	(6.5)
6 mm	10 mm	10	(7.5)	15	(11)
8 mm	13 mm	25	(18)	35	(26)
10 mm	16 mm	50	(37)	75	(55)
12 mm	18 mm	85	(63)	130	(97)
16 mm	24 mm	215	(159)	315	(232)
20 mm	30 mm	435	(321)	620	(457)
24 mm	36 mm	750	(553)	1070	(789)
30 mm	46 mm	1495	(1103)	2130	(1571)



CAUTION: Use only metric tools on metric hardware. Other tools may not fit properly. They may slip and cause injury.

DO NOT use these values if a different torque value tightening procedure is listed for a specific application. Torque values listed are for general use only. Check tightness of cap screws periodically.

Shear bolts are designed to fail under predetermined loads. Always replace shear bolts with identical grade. Fasteners should be replaced with the same or higher grade. If higher grade fasteners are used, these should only be tightened to the strength of the original.

Make sure fastener threads are clean and you properly start thread engagement. This will prevent them from failing when tightening.

Tighten plastic insert or crimped steel-type lock nuts to approximately 50 percent of amount shown in chart. Tighten toothed or serrated-type lock nuts to full torque value.

SET-UP & ASSEMBLY

Note: Determine right and left side of spreader by viewing it from the rear. If instructions or parts lists call for hardened bolts, refer to Cap Screw Torque Value page to identify.

PREPARING MANURE SPREADER

The Manure Spreader may be shipped without the wheels/tires installed.

1. Attach the wheels with tires, using the lug nuts furnished and torque the mounting hardware to the appropriate torque. Wheel bolts should be tightened at 100 ft./lbs. of torque.
2. Check the tires and inflate to the recommended pressure (295/75RX22.5 tires to 75 to 80 psi. - 16.5 x 16.1 tires to 36 psi.)
3. Check for proper assembly and adjustment and make sure that all bolts are tightened.
4. Securely retighten after a few hours of operation, as bolts can loosen up on new machinery.
5. Lubricate the machine completely, check the oil level of the gearbox, fill if necessary.

TRANSPORTING

REFLECTORS/SMV

There is a holder provided for your SMV sign. Unless otherwise prohibited, use a slow-moving vehicle emblem. Never tow the manure spreader on a public highway at a speed greater than 20 m.p.h. (32 kph). Regularly clean the reflective tape at the rear of the spreader.

LIGHTING (Optional)

When transporting on the highway, connect the spreader to the tractor with a lighting power cord. The optional lighting system is to be connected to the 7 pin power receptacle (per SAEJ560B) on your tractor. If your tractor is not equipped with the proper receptacle, see your tractor dealer for details. Make sure lights are functioning properly.



(Shown w/optional upper beater)

SAFETY CHAIN (Optional)

Follow state and local regulations regarding use of a safety chain and transport lighting when towing farm equipment on public highways. A proper safety chain should be used to retain the safety connection between the towing and towed machines, in the event of separation of the primary attaching system. Check with local law enforcement agencies for your own particular regulations. Never tow the manure spreader on a public highway at a speed greater than 20 mph (32 kph).

1. Chain is sufficiently slack to allow turns and movements of either the tractor or the manure spreader, without placing tension on the chain.
2. Chain is of sufficient strength to hold the decoupled implement (and its load) and tow it to the shoulder.

PREPARING FOR OPERATION

TRACTOR CONNECTIONS

Tractor Hitch

Fasten the spreader hitch to the drawbar with a **hitch pin with a safety locking device**. Remove the weight from the jack (jack is not to be used when spreader is loaded). Remove jack from pipe mount and place on convenient storage mount located on the top of left hitch channel. This allows protection of jack from tractor tires during turns. The hitch of the spreader is designed for a standardized tractor hitch. Adjust the drawbar so that it is 13 to 17 inches above the ground. Extend or shorten it so that the horizontal distance from the end of the tractor power takeoff shaft to the center of the hitch pin hole is 14 inches for 540 PTO and 15-3/4" for 1000 PTO as shown in drawing. An improperly located hitch point may cause damage to the universal joints of the power takeoff. Secure the drawbar so that the hitch pin hole is directly below the power drive line.

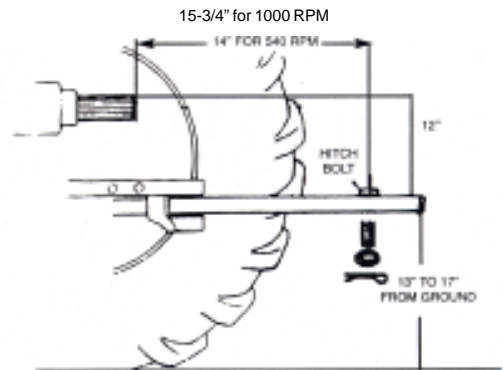

PTO

Attach the PTO of the spreader to the tractor by sliding the spring loaded locking collar on PTO yoke rearward, then sliding it onto the tractor PTO shaft. Release spring loaded collar. Be sure the pins fall into the groove of the tractor PTO shaft and collar snaps forward into locking position.

CAUTION: Do not use a steel hammer to aid in joining PTO parts.

If this implement is attached to a tractor with a clevis hitch (hammer-strap) style drawbar, the hammer-strap must be removed to prevent damage to the IID guarding and the IID telescoping members. [See Figure 1]

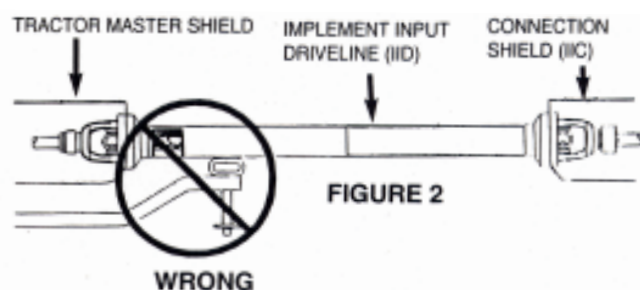
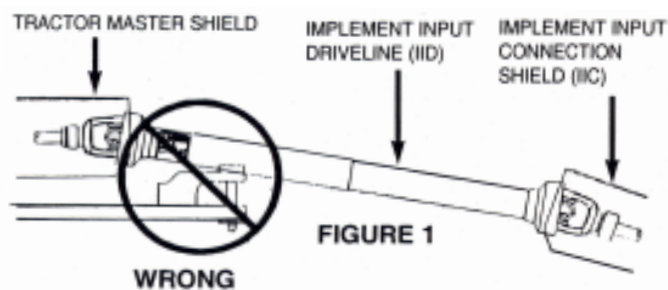

If this implement is attached to a tractor with an offset in the drawbar, be certain it is in the down position to prevent damage to the IID guarding and the IID telescoping members. [See Figure 2]

Manure Spreader Speed Control

Attach the manure spreader speed control/beater engage/disengage rope to a convenient point on the tractor.

OPERATION

EMERGENCY SHUTDOWN

If a foreign object becomes lodged in the beater area and shears the shear bolt, disengage the PTO. Stop the tractor engine, remove the ignition key, and allow all mechanisms to stop before cleaning or working on the spreader.



WARNING: Some photographs used in the following pages show guards or shields removed for clarification. **NEVER** operate machine until these guards or shields are in proper operating position.

LOADING

In freezing weather, make certain that hydraulic tail gate (if equipped with one) is not frozen to the sides or on the floor of the spreader. Make sure the apron chain is not frozen to the spreader floor or any lumps of manure are frozen to the floor. Begin loading the spreader at the front end and work toward the rear until loading is completed. Loading this way permits the material to be spread uniformly. Loading front to rear is particularly important when the spreader is loaded by a mechanical loader because this type of load requires more power to spread than others loads. When hauling extremely heavy materials with a large portion of dirt, it may be necessary to reduce the load size to prevent excessive shear bolt breakage. Never dump material onto the beater. Do not use extra sideboards. Do not overload spreader. Overloading decreases spreading effectiveness. Do not load more than 15 inches above the beater.

SPREADING - 2 SPEED

NOTE: Two speed drive mechanism and beater engage/disengage are controlled by one rope leading to the tractor.

1. When ready to unload, make sure beater is in the engaged position and low speed indicator is visible through low speed hole in panel of spreader.
2. Raise the hydraulic endgate.
3. Engage the tractor PTO shaft slowly.
4. Increased apron speed, if desired, can be accomplished by steadily pulling on the rope until it stops. Speed select indicator should now be visible through the high speed hole. Beater will continue to operate and apron speed will be increased.
5. When the Manure Spreader is almost empty, the bed can be cleaned by shifting into clean out position. Apply a steady pull on the rope until it stops and speed indicator is visible in the clean out hole. In this position, the beater will stop and the apron will continue to operate at the same speed as in high speed position, thus saving unnecessary driving.
6. When spreader is empty, shut off tractor PTO. Pull control rope until speed select indicator snaps into low speed. This will re-engage beater for the next load. DO NOT SHIFT FROM CLEAN OUT TO LOW SPEED WITH THE TRACTOR PTO RUNNING.
7. Do not operate the Manure Spreader with a PTO speed greater than 540 RPM's unless necessary sprocket changes have been made.



Low Speed



High Speed



Clean Out

OPERATION

SPREADING - WITH OPTIONAL HYDRAULIC DRIVE

1. Engage tractor PTO shaft slowly. Beater is always in the engaged position, therefore, engaging tractor PTO will automatically start beater.
2. Raise the hydraulic tailgate.
3. Open hydraulic valve on tractor connected to speed control valve on Manure Spreader.
4. Control speed of apron by turning speed control handle clockwise to increase speed, counter-clockwise to decrease speed.
5. When the Manure Spreader is almost empty, the bed can be cleaned out by disengaging tractor PTO (which will stop beater), and increasing apron speed by turning control handle clockwise, thus saving unnecessary driving time.

FAILURE TO FOLLOW THE RECOMMENDED ADJUSTMENTS WILL VOID WARRANTY

ADJUSTMENTS

DRIVE CHAIN

To adjust front drive chain, loosen jam nut turn nut on adjusting rod (located at the right hand front side of spreader) clockwise. There should be 1/2" deflection at the center of the drive chain. Over tightening or too loose of a chain will result in excessive wear on the bearing, chain and sprockets. Retighten jam nut.

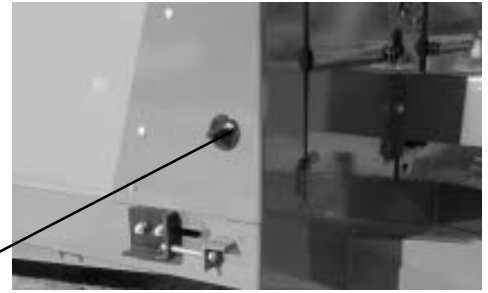

Tightener Bolt

APRON SPEED AND BEATER CONTROL

One cable controls both the beater clutch and two speed clutch. To compensate for wear or stretching of this cable, adjust the turnbuckle behind shield at the front of the spreader.

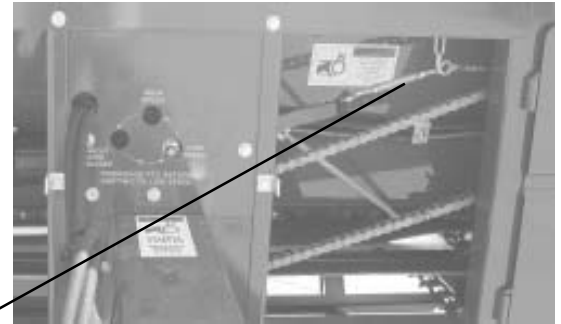

Turnbuckle

Shields Removed for Clarity

TWO SPEED CLUTCH

If clutch control yoke becomes worn, it may be necessary to adjust the high speed clutch so it engages and disengages completely. Adjustment to compensate for this wear is made by sliding spring stop (A) on control rod closer to the clutch engaging lever. Initial adjustment should be made as follows: Distance (B) between spring stop and jam nut is seven (7") inches. Distance (C) between jam nut and shifting rod bracket is one-eighth (1/8") inches. This distance may be achieved by adjusting the turnbuckle at front of spreader.

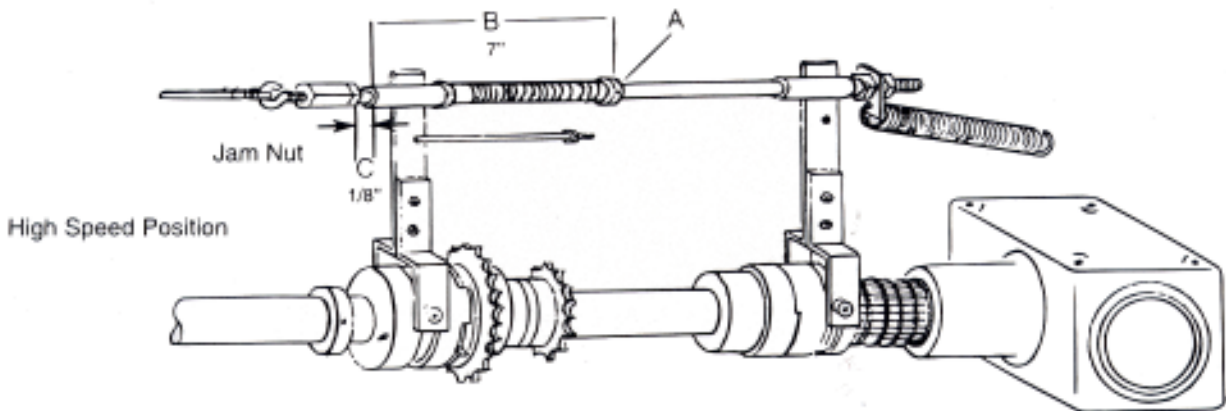

WHEEL HUBS

To adjust wheel hubs, tighten the castellated nut on the spindle to the point where there is no end-play and a slight drag on the bearings. Replace the cotter key with a new one of the correct size.

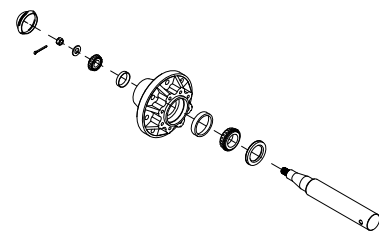

ADJUSTMENTS

BEATER CLUTCH ADJUSTMENT

It may be necessary to compensate for wear in the beater clutch and clutch control yoke. When properly adjusted the moveable jaw clutch should have one-quarter ($1/4$ ") inch (distance C) between clutches when disengaged. To adjust, loosen jam nut (A) holding spring bracket. With beater disengaged (clean out position), tighten nut (B) against shifter lever bracket until the proper distance between clutch jaws is reached. Overtightening will cause beater not to fully engage and cause excess tension on cable. Tighten lock nut (D) so there is one thirty-second ($1/32$ ") inch clearance between clutch jaws (E).

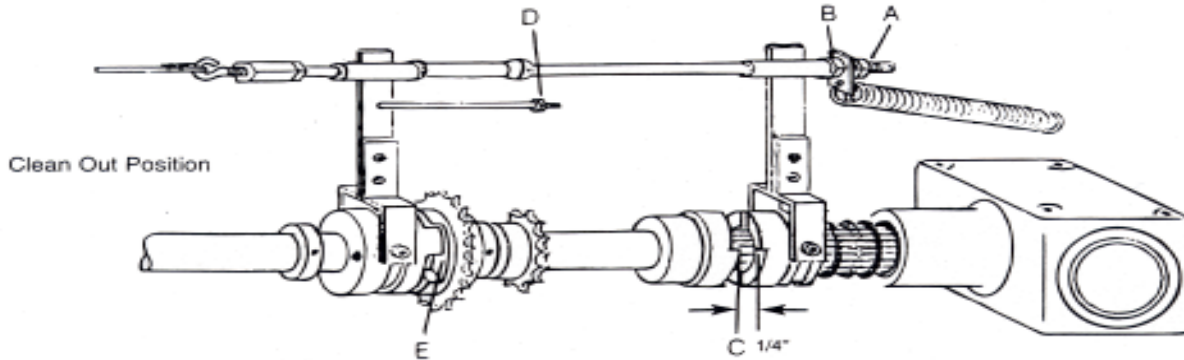

APRON

1. Adjust the apron by loosening the mounting bolts on the chain slides on the outside of the frame. Mounting bolts shown in the drawing.
2. Tighten the adjusting bolts until the apron chain clears the underside of the axle by 1 inch.
3. Retighten jam nut.

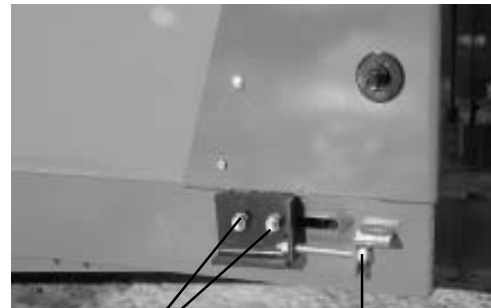

Mounting Bolts Adjusting Bolt

NOTE: Tighten the adjusting bolts (on each front corner) equally on each side so that the apron slats run parallel with the ends of the bed. The apron will be damaged if the machine is operated with one end of the apron slats running ahead of the opposite end. Do not tighten the apron chains excessively.

APRON WORM DRIVE CHAIN

The apron worm drive chains are kept tight with a spring type tightener that does not require adjustment. However, periodic inspection should be made to check for wear.

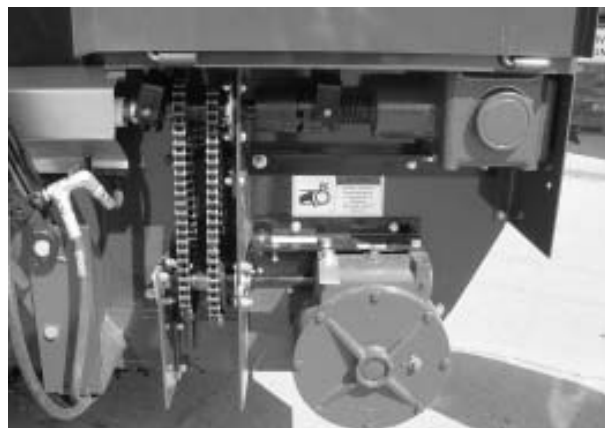

SERVICE

SHEAR BOLTS - Main Drive

The beater and the apron drive are protected by one shear bolt located on the front end of the side drive shaft (left side of spreader). Two spare shear bolts are provided. Shearing of the bolts is normally due to foreign objects in the manure or **starting the spreader PTO too quickly** with high tractor RPM's. Always use H&S shear bolts when replacing shear bolts.

Spare Shear Bolts
Shear Bolt

Shields Removed for Clarity

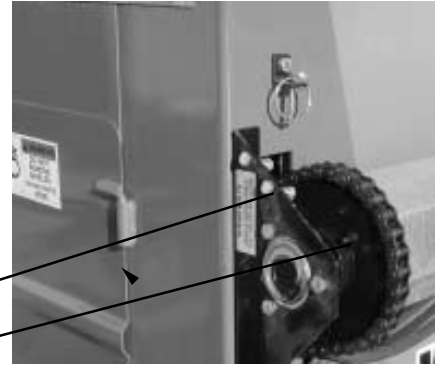

SHEAR BOLTS - Apron Drive

The worm gearbox and apron are protected by two shear bolts. One on the driven high speed sprocket (A) and one on the low speed sprocket (B). Two spare shear bolts are provided (C). Shearing of these bolts is normally due to the apron being frozen fast to the floor, or catching on frozen "chunks". Occasionally the shear bolts will shear due to the spreader being overloaded. Always determine the cause of failure, and eliminate the cause before replacing the shear bolt, using H&S shear bolts when replacing shear bolts.

NOTE: Normal apron speeds at 540 RPM are: low speed 4-1/2 fpm, high speed and clean out position 8-1/2 fpm. If the apron is not moving at these speeds, especially in high or clean out, check and replace the high speed shear bolt (A). **Failure to do so will result in serious damage to the sprocket and shaft.**

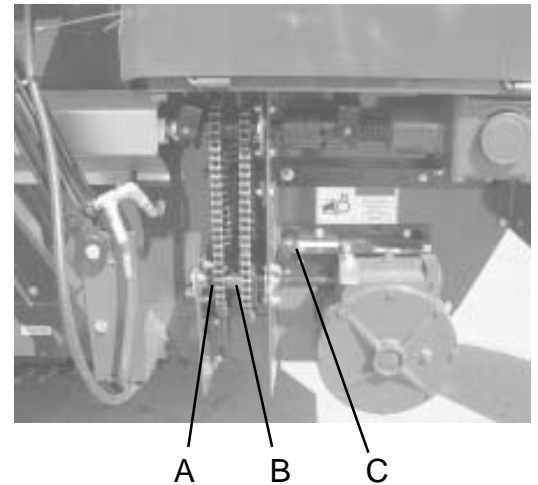

Shields Removed for Clarity

BEATER

When replacing beater paddles, the sharp edges of the teeth must lead in the direction of beater travel. On the right half of the beater the teeth must point to the right side of the spreader. On the left half of the beater the teeth must point to the left side of the spreader. Always use H&S special grade 5 bolts, washers, and nuts when replacing. Torque to 60 foot lbs.



(Shown w/optional upper beater)

WHEEL BEARING LUBRICATION, CLEAN & RE-PACK INSTRUCTIONS

Wheel hubs are equipped with a grease zerk for regular maintenance. Annually disassemble and clean parts in solvent. Reassemble bearings per instructions in the Service Chapter and tighten the castellated nut on the spindle to the point where there is no end-play and a slight drag on the bearings. Replace the cotter key with a new one of the correct size, bend cotter pin over and re-install cap.

OPTIONAL EQUIPMENT

REAR PAN

The rear pan shown is optional equipment.



UPPER BEATER

An optional upper beater is available and will provide a more uniform spreading in heaped and heavily matted material. The upper beater may be used with hydraulic endgate.



2nd HYDRAULIC ENDGATE CYLINDER (310)

The H&S 310 manure spreader is equipped with brackets to accept an optional second cylinder to raise and lower the hydraulic endgate. The optional cylinder is located on right hand side of spreader. The kit includes a cylinder, brace, hoses, and connectors to attach to existing cylinder.



NOTE: DOUBLE CYLINDER FOR HYDRAULIC ENDGATE IS STANDARD EQUIPMENT FOR MODELS 370 & 430.

OPTIONAL EQUIPMENT

HYDRAULIC DRIVE

An optional hydraulic drive unit is available to convert from two speed to variable speed hydraulic drive. Hydraulic drive may be used as a two or four hose tractor hook-up.



Front Control Panel

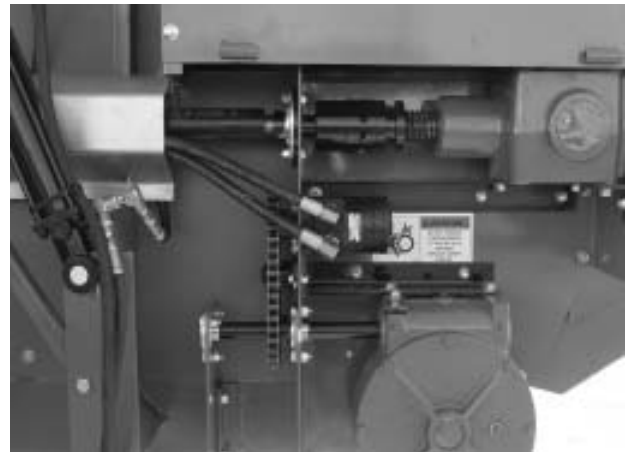

**Hydraulic Motor
Shields Removed for Clarity**

LUBRICATION

GENERAL INFORMATION

IMPORTANT: *Catch and dispose of fluid per local waste disposal regulations whenever service is performed on hydraulic components, valves, cylinders, hoses, etc.*

GREASE FITTINGS

There are numerous grease fittings on the spreader. The operator should become familiar with all lubrication points and establish a systematic routine to insure complete and quick lubrication of the machine. If these are lubricated properly and often enough, it will prolong the life of the spreader. (Grease every 10 hours, **also before and after power washing.**) Make certain that the grease fittings are free of paint and dirt, force a high-quality grease into them until the grease comes out around the shaft on the sleeve-type bearings. On the sealed ball bearings, grease should be added slowly until a slight bead forms at the seals indicating the correct amount of lubricant. Wipe off excess grease to prevent the accumulation of chaff and grit around the bearings.

DRIVE CHAINS

Lubricate the drive chains with a light machine oil. Keep chains aligned with sprockets, this will lengthen the life of the sprockets and chain. Lubricate chains often.

GEARBOX

Before using your new machine, check the oil in the main apron drive and beater drive gearbox. Keep the gearbox filled to the oil plug on the side of the gearbox as shown with 80/90 gear lube.

**Beater
Gearbox
Oil
Level**

**Main
Apron
Gearbox
Oil
Level**

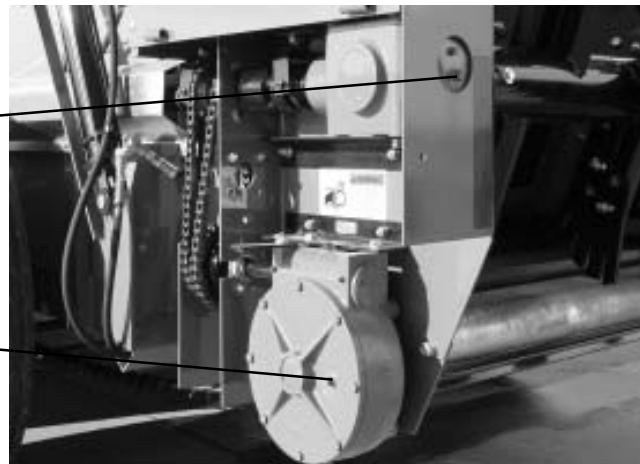

PTO ASSEMBLY

Keep the male and female shafts of the PTO well lubricated and free sliding. Failure to observe this precaution will result in excessive pressure being required to collapse or extend the assembly while subject to operating torque. This excessive force may damage the main shaft bearings. Never lubricate the shield surfaces. The shield surfaces must be kept dry, as dirt accumulation on them will cause the shields to bind and not rotate. Dented or damaged PTO shields, will also result in excessive force being applied against the jackshaft. If at any time the shields do not turn freely, they should be checked to determine the cause, and repaired or cleaned. To avoid damage to the main drive bearings, avoid turning sharp corners while the PTO is running. Start and Stop the PTO slowly to avoid damage to the drive line.

LUBRICATION

GREASE ZERK LOCATION - Grease every 10 Hours

- | | | | |
|----|---------------------------------|----|-----------------------------------|
| A. | (3) PTO Shaft | H. | (2) Tailgate Arms |
| B. | (2) Front jack shaft bearings. | I. | (2) Axle Pivot (Model 310) |
| C. | (2) Rear Drive Shaft | J. | (4) Axle Pivot (Model 370/430) |
| D. | (1) Beater | K. | (1) Beater Clutch Control Yoke |
| E. | (2) Worm Drive Gearbox | L. | (1) Two Speed Clutch Control Yoke |
| F. | (4) Side Shaft (Models 370/430) | M. | (1) Two Speed Clutch Throwout |
| G. | (3) Side Shaft (Model 310) | N. | (1) Rear Support Bearing |
| | | O. | (4) Zerks on hubs (1 on each hub) |

NOTE: Shields removed in some pictures for clarity. **DO NOT OPERATE WITH SHIELDS REMOVED.**

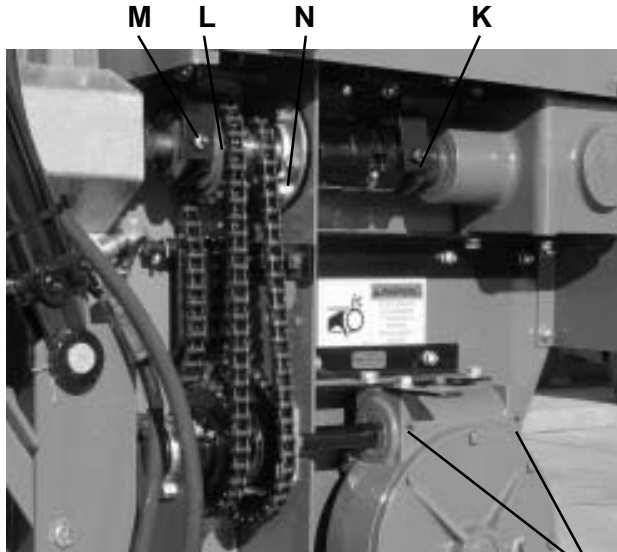

Shields Removed for Clarity

E



C

D

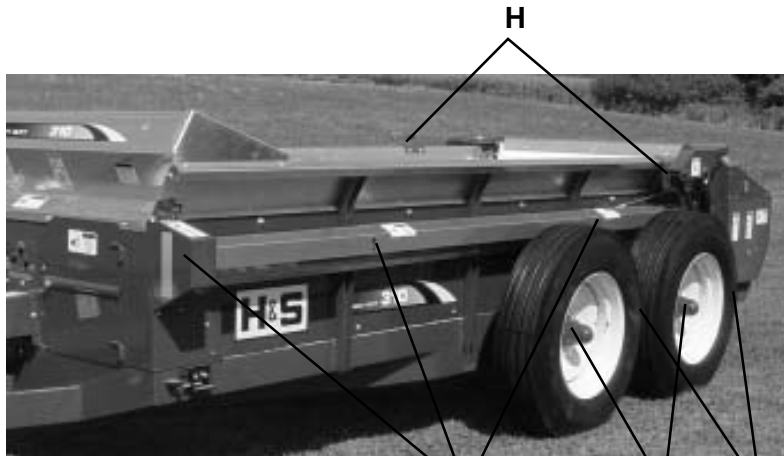

H

F-G

O

I-J

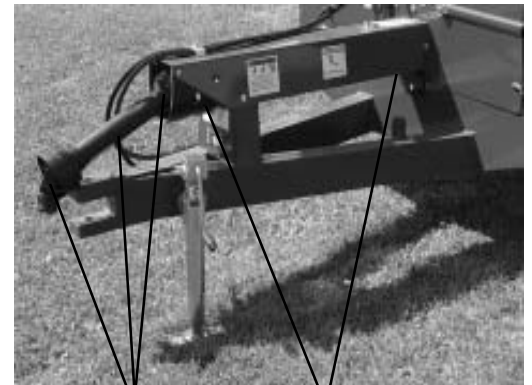

A

B

WHEEL BEARING LUBRICATION, CLEAN & RE-PACK INSTRUCTIONS

Wheel hubs are equipped with a grease zerk for regular maintenance. Annually disassemble and clean parts in solvent. Reassemble bearings per instructions in the Service Chapter and tighten the castellated nut on the spindle to the point where there is no end-play and a slight drag on the bearings. Replace the cotter key with a new one of the correct size, bend cotter pin over and re-install cap.

DECAL LOCATION

Your H&S Manure Spreader was manufactured with operator safety in mind. Located on the Manure Spreader are various decals to aid in operation, and warn of danger or caution areas. Pay close attention to all decals on your Manure Spreader.



DO NOT REMOVE ANY OF THESE DECALS. IF THE DECALS ARE LOST, DAMAGED, OR IF THE MANURE SPREADER IS REPAINTED, REPLACE DECALS. REMEMBER: DECALS ARE FOR YOUR PROTECTION AND INFORMATION.

Listed below are the decals on your Manure Spreader. These decals may be ordered individually by part number or by ordering a complete set.

<u>PART #</u>	<u>QTY</u>	<u>DESCRIPTION</u>
1494A	3	Warning - Do Not Operate
1494B	2	Warning - Do Not Remove Shields
1494H	1	Danger - Stay Clear
1494J	2	Warning - Do Not Clean or Work
1494K	3	Warning - Do Not Remove Shields
1494L	1	Danger - Rotating Driveline
093020	2	Grease
11599	1	Warning - Stay Clear of Leaks
111593A	2	Danger - Stay Clear of Beater
111593C	2	Warning - Stay Clear of Endgate
12794	2	Warning - Do Not Remove Shields
112-11176	2	Shear Bolts
311	1	Patent Number
3187	1	Speed Indicator (Only on if equipped with hydraulic drive)
3494A	2	Remote Grease - Axle Pivot
54033	1	3" Made in USA
71188B	1	Jack Storage Position
71188H	1	Beater/Apron Control
71494A	3	Warning Do Not Operate
72203A	1	Warning - Help Avoid Injury
82602	1	Warning - Crushing Hazard
9194A	2	Danger - No Step
9194B	1	Danger - Never Allow Riders
93466	1	540 RPM
DCAMB	5	Amber Reflector
DCRED	2	Red Reflectors
8396	1	Decal-310 Spreader Left 60"W x 8"H
8397	1	Decal-310 Spreader Right 60"W x 8"H
8398	1	Decal-310 Spreader Front 48"W x 5"H
8399	1	Decal-370 Spreader Left 66"W x 7"H
8400	1	Decal-370 Spreader Right 69"W x 8"H
8401	1	Decal-370 Spreader Front 48"W x 5"H
8402	1	Decal-430 Spreader Left 66"W x 7"H
8403	1	Decal-430 Spreader Right 69"W x 8"
8404	1	Decal-430 Spreader Front 48"W x 5"H

DECAL LOCATION

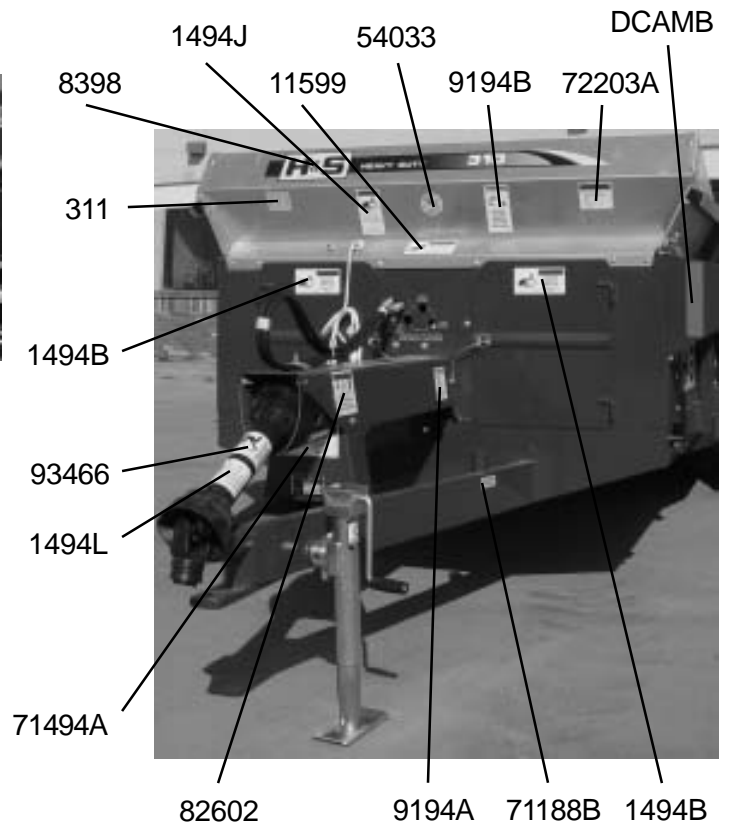
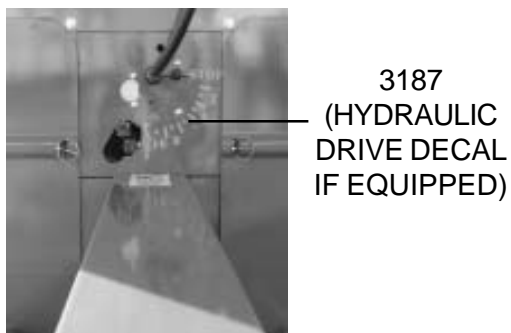
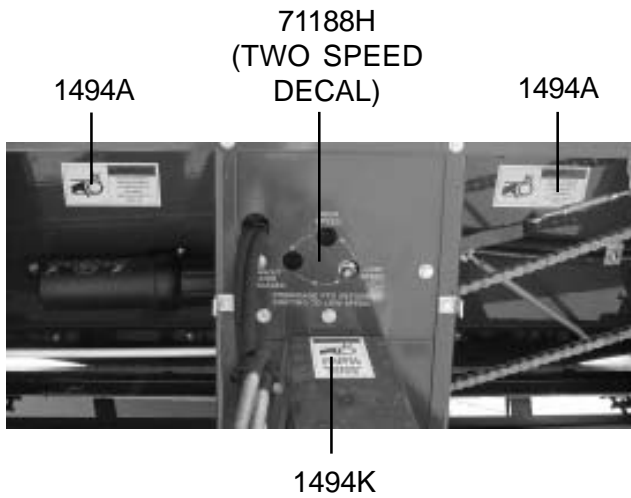
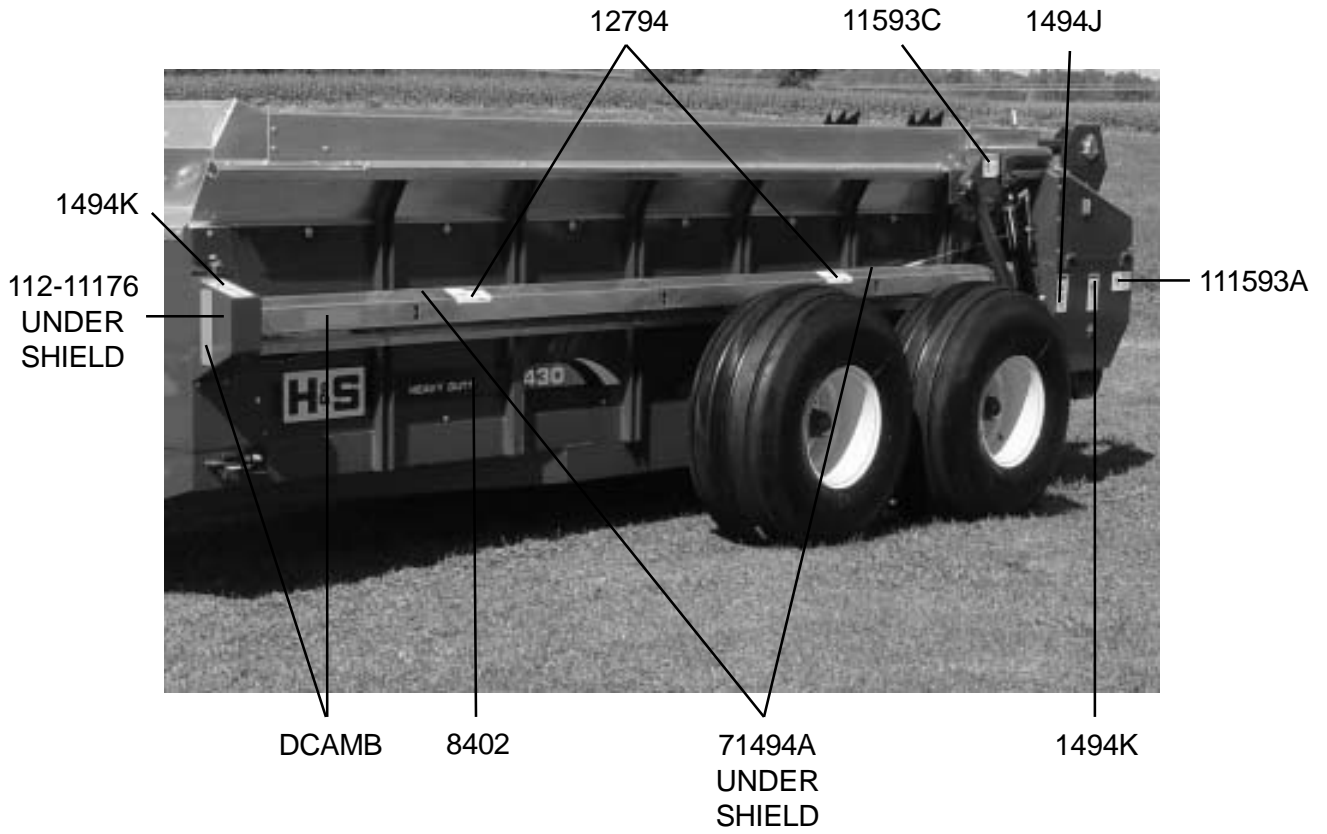

DECAL LOCATION

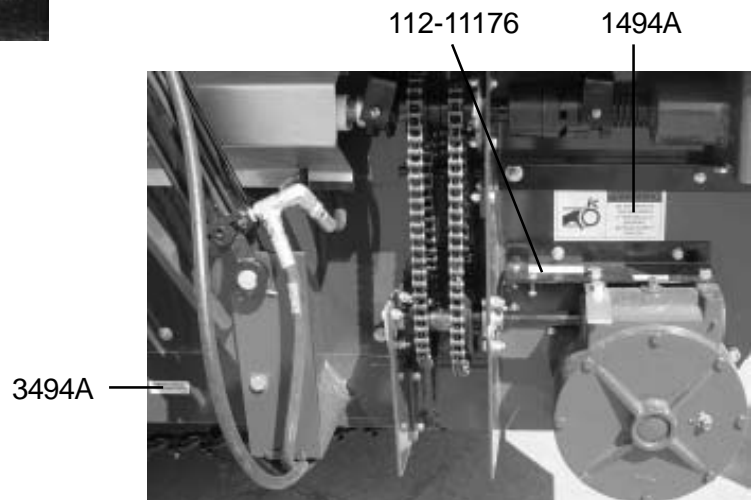
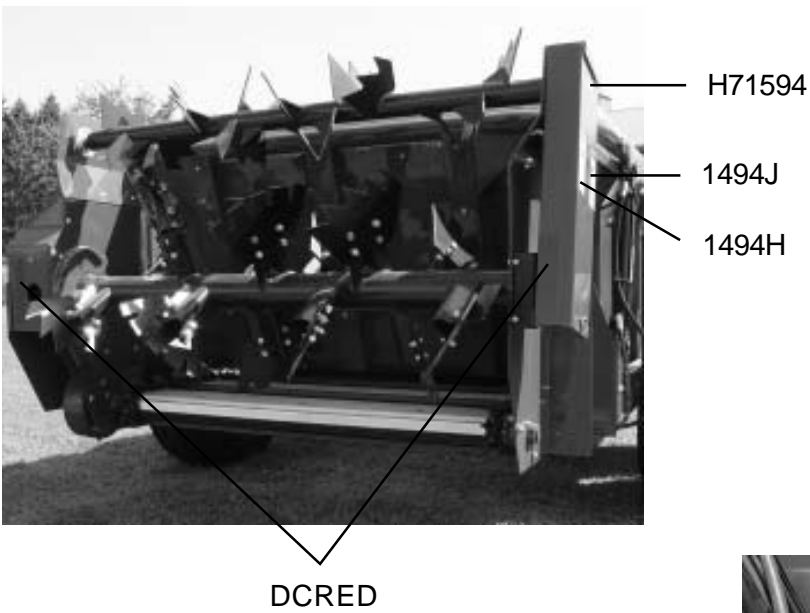
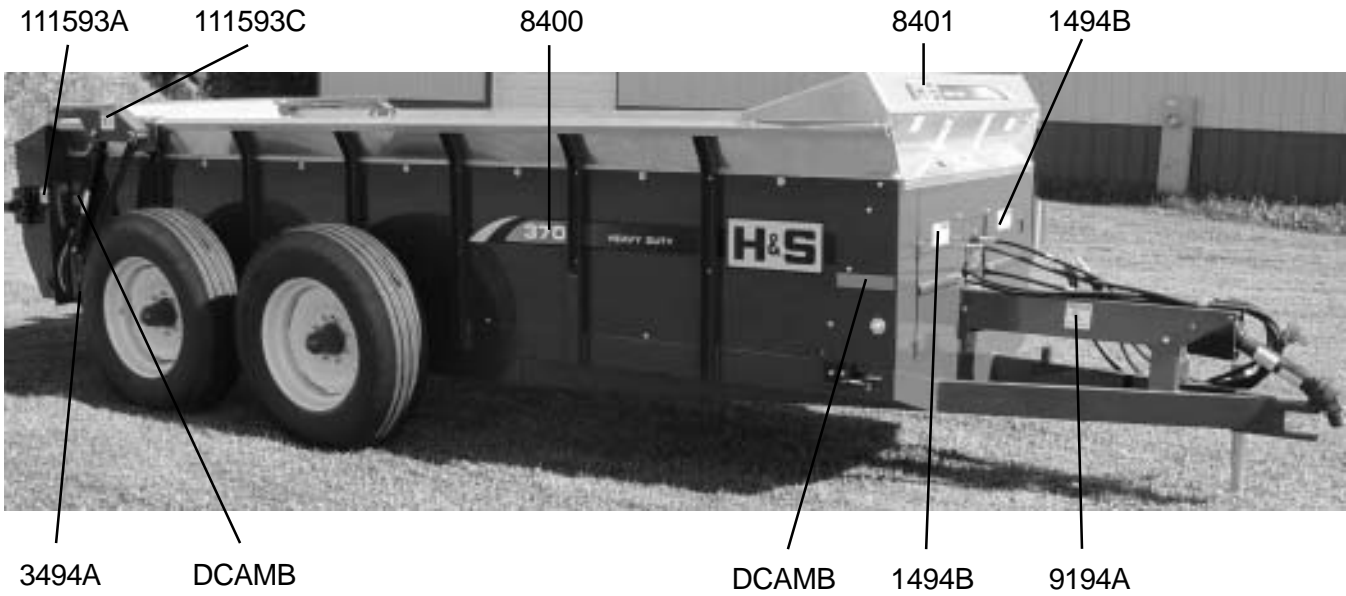

TROUBLE SHOOTING



WARNING:

MAKE SURE THAT THE TRACTOR IS SHUT OFF AND THE SPREADER CAN NOT MOVE BEFORE SERVICING THE MANURE SPREADER. MAINTENANCE AND REPAIR SERVICE WORK TO BE PERFORMED BY A QUALIFIED SERVICE PERSON ONLY.

TROUBLE...	POSSIBLE CAUSE...	POSSIBLE REMEDY...
Beater Does Not Turn Insert and	PTO Not Turning	Engage Tractor PTO
	Beater Not Engaged	Engage Beater
	Main Drive Shear Bolt Sheared	Replace Main Drive Shear Bolt
	Front Drive Chain Off, Broken, or Missing	Replace or Repair Front Drive Chain
	Control Cable out of Adjustment	Adjust Control Cable
	Splined Beater Insert Worn or Splines Sheared Off	Replace Splined Beater Gearbox Output Shaft
Beater Will Not Disengage	Control Cable Out of Adjustment	Adjust Control Cable
	Control Linkage Binding	Check Control Linkage, Make Sure It Is Free Moving
Apron Does Not Turn	PTO Not Turning	Engage Tractor PTO
	Main Drive Shear Bolt Sheared	Replace Main Drive Shear Bolt
	Front Drive Chain Off, Broken, or Missing	Replace or Repair Front Drive Chain
Apron Only Drives In Low	High Speed Shear Bolt Sheared or Missing	Replace Sheared or Missing Shear Bolt
Apron only Drives in High	Low Speed Shear Bolt Sheared or Missing	Replace Sheared or Missing Shear Bolt
	Dog or Dog Spring Worn, Broken or Missing	Replace Worn, Broken or Missing Dog or Dog Spring
	Shear Plate Worn	Replace Shear Plate

SPECIFICATIONS

	<u>310</u>	<u>370</u>	<u>430</u>
Top Flare Width.....	68'	68"	68"
Inside Width.....	59-3/4"	59-3/4"	59-3/4"
Inside Length.....	15'7"	16'6"	16'6"
Inside Depth.....	28-3/8"	34-3/8"	40-3/8"
Overall Width w/295/75R22.5 Tires.....	97"	97"	N/A
Overall Width w/16.5 x 16.1 Tires.....	107"	107"	107"
Overall Length.....	21'-11-1/2"	23'-2-1/2"	23'-2-1/2"
Overall Loading Height (Top of Flare).....	51-1/2"	57-1/2"	63-1/2"
Overall Height w/Hyd. Endgate.....	55"	61"	67"
Diameter of Beater.....	29"	29"	29"
Weight w/295/75R22.5 Tires.....	4190 Lbs.	4920 Lbs	N/A
Weight w/16.5 x 16.1 Tires.....	4200 Lbs.	4930 Lbs.	5220 Lbs
Capacity (Old Rating).....	310 Bu.	370 Bu	430 Bu.
Capacity - Cu. Ft. Struck Level.....	185.	235.	275
Rear Hydraulic Endgate.....	Standard	Standard	Standard
Semi Liquid Rear Pan.....	Optional	Optional	Optional
Upper Beater.....	Optional.	Optional	Optional
Drive.....	Two Speed Clutch to Worm Gear All Models		
Worm Gear.....	Bronze	Bronze	Bronze
Variable Speed Hydraulic Drive.....	Optional	Optional	Optional
Front Splash Panel.....	Standard.	Standard	Standard
PTO Speed.....	540 RPM.	540 RPM	540 RPM

*** SPECIFICATIONS ARE SUBJECT TO CHANGE WITHOUT PRIOR NOTICE.**

H&S MFG. CO.

products approved

for the

FEMA

SEAL OF QUALITY

