

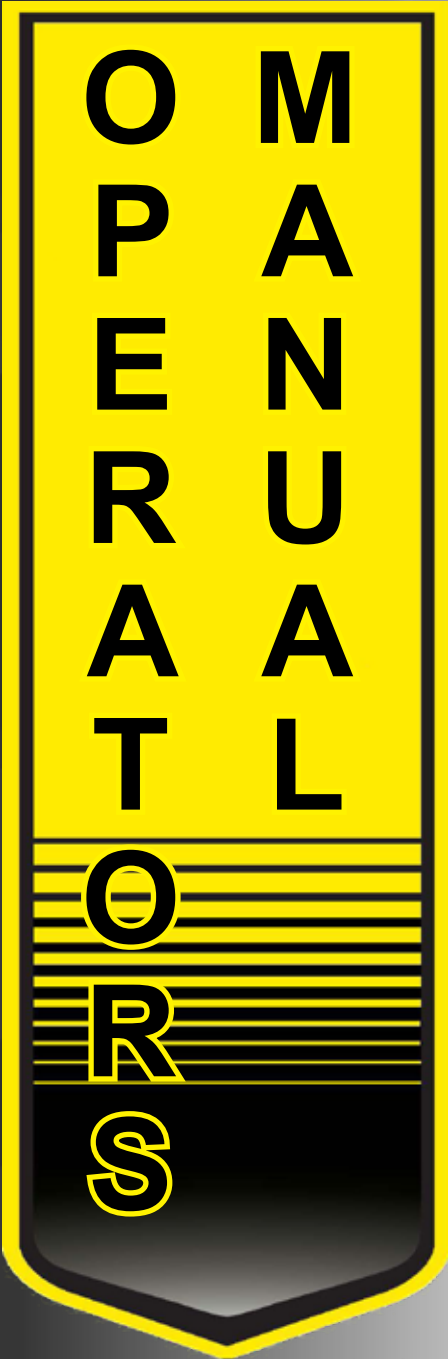

**3210/3212  
ACTION  
RAKE**



**WARNING**

READ AND UNDERSTAND THIS MANUAL BEFORE OPERATING THIS EQUIPMENT. UNSAFE OPERATION OR MAINTENANCE OF THIS EQUIPMENT CAN RESULT IN SERIOUS INJURY OR DEATH.

3210 Starting w/Serial #222AR10001  
3212 Starting w/Serial #222AR12001

Part #91297

Rev. #00

HSMFG01022

**STRONG HERITAGE - STRONG PEOPLE - STRONGER FUTURE**

# **CONTENTS**

Warranty . . . . .	1
Manufacturer's Statement . . . . .	2
Warranty Registration Form . . . . .	3
Dealer Pre-Delivery Checklist . . . . .	5
Delivery Checklist . . . . .	7
Safety Information - Be Alert Symbol . . . . .	9
Explanation of Safety Signs . . . . .	10
Safety Decals . . . . .	11
Safety Information - Warning - Owner Must Read and Understand . . . . .	12
Cap Screw Torque Value . . . . .	13
Set-Up & Assembly . . . . .	14
Transporting . . . . .	15
Preparing for Operation . . . . .	16
Operation & Adjustments . . . . .	17-19
Optional Equipment . . . . .	20
Lubrication Guide . . . . .	21-22
Decal Location . . . . .	23-25
Troubleshooting Guide . . . . .	26
Service Notes . . . . .	27-28

# H&S WARRANTY

H&S Manufacturing Co., Inc. ("H&S") warrants this product to be free from defect in material and workmanship. Except as noted below, this warranty term is twelve (12) months on labor, and twenty-four (24) months on parts from the date of delivery of the product to the original purchaser by an authorized H&S dealer. Under this warranty, H&S will repair or replace, at its option, any covered part which is found to be defective in material or workmanship during the applicable warranty term. In no case will the covered repair cost of a part or parts exceed the replacement cost of that part. Warranty service must be performed by H&S or a dealer authorized by H&S to sell and/or service the product involved, which will use only new or remanufactured parts or components furnished by H&S. This warranty includes approved parts and labor to fix the product but does not include, and the purchaser is responsible for, any service call and/or transportation of the product to and from the dealer's place of business, for any premium charged for overtime labor requested by the purchaser, and for any service work not directly related to any defect covered under this warranty. This warranty includes only those components of the product manufactured by H&S. Warranty for any component not manufactured by H&S including, but not limited to, engines, batteries, tires, rims, hydraulic motors, pumps, etc. are covered by the warranty, if any, provided separately by their respective manufacturers.

This warranty in all its parts, is extended solely to the original purchaser of the product, is terminated upon any subsequent transfer or sale from or by the original purchaser and extends no third party benefits or rights whatsoever.

The warranty term for any product used in any commercial, custom, for hire or rental application, is limited to six (6) months from the date of delivery of the product to the original purchaser or the first day of service, whichever comes first, by an authorized H&S dealer.

For commercial, custom for hire, or rental application, warranty is limited to 6 months from the date of delivery to the original purchaser, or the first day in service, whichever is earlier.

This warranty does not include:

- (1) Any product that has been altered or modified in ways not approved by H&S;
- (2) Depreciation or damage caused by normal wear, use for which the product was not designed, misuse, improper or insufficient maintenance, improper operation, accident or failure to follow the product Operator's Manual recommendations and product decal recommendations;
- (3) Normal maintenance parts and service;
- (4) Repairs made with parts other than those available from H&S or performed by anyone other than H&S or a dealer authorized by H&S to sell and/or service the product involved.

To secure warranty service the purchaser must report the product defect to a dealer authorized by H&S to sell and/or service the product involved within the applicable warranty term together with evidence of the warranty start date and make the product available to that dealer within a reasonable period of time.

**THERE ARE NO WARRANTIES WHICH EXTEND BEYOND THE DESCRIPTION ON THE FACE OF THIS WARRANTY.** H&S and the companies affiliated with it makes no warranties, representations, or promises, express or implied, as to the performance or freedom from defect of its products other than those set forth above and **NO IMPLIED WARRANTY OF MERCHANTABILITY, FITNESS OR FITNESS FOR A PARTICULAR PURPOSE IS MADE. IN NO EVENT WILL THE DEALER, H&S OR ANY COMPANY AFFILIATED WITH H&S BE LIABLE FOR INCIDENTAL OR CONSEQUENTIAL DAMAGES.** The ONLY REMEDY the purchaser has in connection with the breach of performance of any warranty on H&S products are those set forth above.

The selling dealer has no authority to make any representation or promise on behalf of H&S, or to modify the terms or limitations of this warranty in any way.

11/14/18

## **MANUFACTURER'S STATEMENT**

Your New H&S Product has been manufactured of the finest quality materials and components. The performance you get from your machine is largely dependent upon how well you read and understand this manual and apply this knowledge. There is a right and a wrong way to do everything. Please do not assume that you know how to operate and maintain your Machine before reading this manual carefully. Keep this manual available for ready reference.

H&S reserves the right to make changes or add improvements to its products at any time without incurring any obligation to make such changes to products previously manufactured. Specifications, statements and descriptions of Products contained in this publication are subject to change without prior notification.

## WARRANTY REGISTRATION

- Date of Purchase: \_\_\_\_\_
- Purchaser Name: \_\_\_\_\_
- Street Address: \_\_\_\_\_
- City: \_\_\_\_\_
- State: \_\_\_\_\_ Zip: \_\_\_\_\_
- Phone Number: \_\_\_\_\_
- E-mail Address: \_\_\_\_\_
- Product: \_\_\_\_\_
- Model Number: \_\_\_\_\_
- Serial Number: \_\_\_\_\_
- You have received the Operator's Manual for this product. Yes \_\_\_\_\_ No \_\_\_\_\_
- Interested in receiving the H&S E-mail Newsletter? Yes \_\_\_\_\_ No \_\_\_\_\_

- 
- Dealer Name: \_\_\_\_\_
  - Street Address: \_\_\_\_\_
  - City: \_\_\_\_\_
  - State: \_\_\_\_\_ Zip: \_\_\_\_\_
  - Signature: \_\_\_\_\_

- All fields must be filled out to ensure prompt notification of product and/or warranty updates.

**Please mail the completed WARRANTY REGISTRATION FORM to:  
H&S Manufacturing Co., Inc.  
2608 S. Hume Ave.  
Marshfield, WI 54449**

**Intentionally Left Blank**

# DEALER PRE-DELIVERY CHECKLIST

## **AFTER COMPLETION, DEALER SHOULD REMOVE AND RETAIN FOR RECORDS**

After the Rake has been completely set up, check to be certain it is in correct operating order before delivering to the customer. The following is a list of points to inspect. Check off each item as you have made the proper adjustments and found the item operating satisfactorily.

- Rake was not damaged in shipment. Check for dents and loose or missing parts. Report damage immediately to H&S Manufacturing Co., Inc.
- Rake has been correctly assembled according to instructions in this manual or the set-up instruction manual.
- Wheel nuts and all other fasteners are tightly secured.
- All bolts and fasteners are tight.
- All grease fittings have been lubricated. See Lubrication Chapter of this manual for details.
- Hoses and fittings are properly attached and there are no visible leaks.
- All mechanisms are operating trouble free.
- Wheels are properly mounted.
- Tires are inflated to correct pressure.
- Decals are in place and legible.

Model Number \_\_\_\_\_

Serial Number \_\_\_\_\_

Dealer's Name \_\_\_\_\_

Inspection Date \_\_\_\_\_

Signature of Pre-Delivery Inspector \_\_\_\_\_

(Remove Dealers File Copy At Perforation)

**Intentionally Left Blank**



# DEALER DELIVERY CHECKLIST

## **AFTER COMPLETION, DEALER SHOULD REMOVE AND RETAIN FOR RECORDS**

This checklist that follows is an important reminder of valuable information that should be passed on to the customer at the time this rake is delivered.

Check off each item as you explain it to the customer.

This delivery checklist, when properly filled out and signed, assures the customer that the pre-delivery service was satisfactorily performed.

- Explain to the customer that the pre-delivery inspection was made.
- Explain to the customer all the safety precautions they must exercise when operating this unit.
- Explain raking and windrow width adjustments.
- Explain to customer that regular lubrication is required for proper operation and long life of machine.
- Show customer the lubrication section of Owner's Manual.
- Give the customer the Owner's Manual and make sure they read and understand all operating and service instructions.
- Have the customer sign a completed "Warranty Registration" and mail it.

Date Delivered \_\_\_\_\_

Dealer's Name \_\_\_\_\_

By \_\_\_\_\_

Signature of Original Buyer \_\_\_\_\_

Note: Warranty is not valid until warranty card is completed and returned to H&S Mfg. Co., Inc.

**Intentionally Left Blank**

**SAFETY INFORMATION**



**BE  
ALERT!**

**YOUR SAFETY  
IS INVOLVED.**

**THIS SYMBOL IS USED THROUGHOUT THIS BOOK WHENEVER YOUR PERSONAL SAFETY IS INVOLVED. TAKE TIME TO BE CAREFUL. REMEMBER: THE CAREFUL OPERATOR IS THE BEST OPERATOR. MOST ACCIDENTS ARE CAUSED BY HUMAN ERROR. CERTAIN PRECAUTIONS MUST BE OBSERVED TO PREVENT THE POSSIBILITY OF INJURY OR DAMAGE.**

**H&S MANUFACTURING CO., INC.**

# SAFETY INFORMATION

Keep signs in good condition. Immediately replace any missing or damaged signs.

## RECOGNIZE SAFETY INFORMATION

This is the safety alert symbol. When you see this symbol on your machine or in this manual, be alert to the potential for personal injury.

Follow recommended precautions and safe operating practices.



## UNDERSTAND SIGNAL WORDS

A single word - DANGER, WARNING, or CAUTION - is used with the safety alert symbol. DANGER identifies the most serious hazards.

Safety signs with a single word DANGER or WARNING are typically near specific hazards.

General precautions are listed on CAUTION safety signs.



**WARNING**



**CAUTION**



## FOLLOW SAFETY INSTRUCTIONS

Carefully read all safety messages in this manual, and all safety signs on your machine. Follow all recommended precautions and safe operating procedures.

## OBSERVE MAXIMUM TRANSPORT SPEED

The maximum transport speed for this implement is 32 km/h (20 mph).

Some tractors are capable of operating at speeds that exceed the maximum transport speed of this implement. Regardless of the maximum speed capability of the tractor being used to tow this implement, do not exceed the implement's maximum transport speed.

Exceeding the implement's maximum transport speed can result in:

- \* Loss of control of the tractor/implement combination
- \* Reduced or no ability to stop during braking
- \* Implement tire failure
- \* Damage to the implement structure or its components

Use additional caution and reduce speed when towing under adverse surface conditions, when turning, and when on inclines.

Do not attempt transport if the fully loaded implement weighs more than 1.5 times the weight of the tractor.



# SAFETY INFORMATION

	<p style="text-align: center;"><b>⚠ WARNING</b></p> <p style="text-align: center;">STAY CLEAR OF RAKE WHEN RAISING OR LOWERING RAKE WHEELS.</p> <p style="text-align: center;">FAILURE TO HEED THIS WARNING MAY RESULT IN <b>PERSONAL INJURY OR DEATH.</b></p> <p style="text-align: center;">KEEP CLOTHING, YOURSELF AND OTHERS WELL CLEAR.</p> <p style="text-align: right; font-size: small;">2700A</p>
---	--

<b>⚠ WARNING</b>		
		
<p><b>CRUSHING HAZARD</b></p> <p><b>TO PREVENT SERIOUS INJURY OR DEATH:</b></p> <p><b>KEEP HANDS AND BODY OUT OF HITCH AREA WHEN ATTACHING TOWING VEHICLE.</b></p> <p><b>KEEP BODY CLEAR OF CRUSH POINT BETWEEN TOWING VEHICLE AND LOAD.</b></p> <p><b>KEEP FEET AND LEGS CLEAR FROM UNDER TONGUE AREA IN CASE OF POSSIBLE JACK FAILURE.</b></p> <p style="text-align: right; font-size: small;">82602</p>		

	<p style="text-align: center;"><b>⚠ WARNING</b></p> <p style="text-align: center;"><b>DO NOT GO NEAR LEAKS</b></p> <ul style="list-style-type: none"> <li>• High pressure oil easily punctures skin causing serious injury, gangrene or death.</li> <li>• If injured, seek emergency medical help. Immediate surgery is required to remove oil.</li> <li>• Do not use finger or skin to check for leaks.</li> <li>• Lower load or relieve hydraulic pressure before loosening fittings.</li> </ul> <p style="text-align: right; font-size: small;">11599</p>
---	--

<b>⚠ DANGER</b>

<p><b>NEVER ALLOW RIDERS ON THIS MACHINE</b></p> <p style="text-align: right; font-size: small;">82907L</p>

<b>⚠ WARNING</b>
<p style="text-align: center;"><b>HELP AVOID INJURY</b></p> <ul style="list-style-type: none"> <li>• READ &amp; UNDERSTAND THE OPERATORS MANUAL PROVIDED WITH THIS MACHINE. IF MISPLACED CALL H &amp; S MANUFACTURING AT 715-387-3414 WITH MODEL AND SERIAL NUMBER.</li> <li>• UNDERSTAND ALL SAFETY WARNINGS AND FUNCTION OF CONTROLS.</li> <li>• KEEP SAFETY DEVICES IN PLACE AND WORKING.</li> <li>• KEEP YOURSELF AND OTHERS WELL CLEAR OF MOVING PARTS.</li> <li>• DISCONNECT ALL POWER BEFORE SERVICING OR CLEANING THIS MACHINE.</li> <li>• DO NOT EXCEED 20 MPH</li> </ul> <p style="text-align: right; font-size: small;">72203A</p>

<b>⚠ WARNING</b>	
	<p><b>STAY CLEAR</b></p> <p style="text-align: right; font-size: small;">1906C</p>

**TRACTOR:**

This operator's manual uses the term "Tractor" when identifying the power source.



# WARNING

**TO PREVENT SERIOUS INJURY OR DEATH**

BEFORE YOU ATTEMPT TO OPERATE THIS EQUIPMENT, READ AND STUDY THE FOLLOWING INFORMATION. IN ADDITION, MAKE SURE THAT EVERY INDIVIDUAL WHO OPERATES OR WORKS WITH THIS EQUIPMENT, WHETHER FAMILY MEMBER OR EMPLOYEE, IS FAMILIAR WITH THESE SAFETY PRECAUTIONS.

**If the machine becomes clogged or for servicing, stop the tractor engine, remove ignition key and allow all mechanisms to stop.**

**Before cleaning or working on the machine, completely disengage the tractor hydraulics.**

**DO NOT** attempt to perform maintenance or repair with tractor running and hydraulic hoses connected to the tractor.

**DO NOT ALLOW PERSONNEL OTHER THAN THE QUALIFIED OPERATOR NEAR THE RAKE.**

**DO NOT** step up on machine at any time.

**DO NOT** allow minors to operate or be near the machine.

Stay clear of rake when raising or lowering main rake beams.

Stay clear of hydraulic lines as they may be under extreme pressure or heat.

For transport and storage, always make sure that the transport lock valves are in the closed position.

H&S Manufacturing always takes the operator and their safety into consideration and guards exposed moving parts for their protection. However, some areas cannot be guarded or shielded in order to ensure proper operation. In addition, the operator's manual and decals on the machine itself warn you of further danger and should be read and observed closely.

## **Study The Above Safety Rules**

**ATTENTION - BE ALERT - YOUR SAFETY IS INVOLVED**

# CAP SCREW TORQUE VALUES

The specifications below are the torque values for fasteners as it adheres to the SAE torque value standards. All fasteners should be torqued to the proper values found in the figures below unless otherwise specified by the engineering drawing.

- Lubed torque would be any fastener that has grease, liquid Loctite, oil, etc. on the threads.
- Dry torque would be any fastener which has threads that are clean and dry and do not have any liquid Loctite or grease on them.

## Hex Head Fasteners

The figure shown below shows how to determine what SAE grade a fastener is.

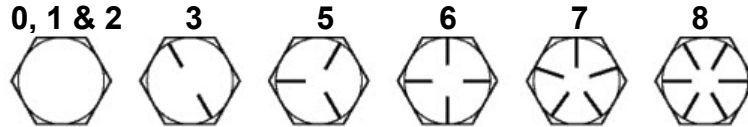

SUGGESTED ASSEMBLY TORQUE VALUES							WORKING TORQUE			
SAE GR. 2-6"		SAE GR. 5		SAE GR. 8			18-8 SS	316 SS	Brass	Silicon Bronze
Dia. & Thrds. per inch	Dry Ft. Lbs.	Lube Ft. Lbs.	Dry Ft. Lbs.	Lube Ft. Lbs.	Dry Ft. Lbs.	Lube Ft. Lbs.	Inch Lbs.	Inch Lbs.	Inch Lbs.	Inch Lbs.
1/4-20	5.5	4.2	8	6.3	12	9	75.2	78.8	61.5	68.6
1/4-28	6.3	4.7	10	7.2	14	10	94.0	99.0	77.0	87.0
5/16-20	11	8	17	13	24	18	132	138	107	123
5/16-28	12	9	19	14	27	20	142	147	116	131
3/8-16	20	15	30	23	45	35	236	247	192	219
3/8-24	23	17	35	25	50	35	259	271	212	240
7/16-14	32	24	50	35	70	50	376	393	317	349
7/16-20	36	27	55	40	80	60	400	418	327	371
1/2-13	50	35	75	55	110	80	517	542	422	480
1/2-20	55	40	85	65	120	90	541	565	443	502
9/16-12	70	55	110	80	150	110	682	713	558	632
9/16-18	80	60	120	90	170	130	752	787	615	697
5/8-11	100	75	150	110	210	160	1110	1160	907	1030
5/8-18	110	85	170	130	240	180	1244	1301	1016	1154
3/4-10	175	130	260	200	380	280	1530	1582	1249	1416
3/4-16	200	140	300	220	420	310	1490	1558	1220	1382
7/8-9	170	125	430	320	600	450	2328	2430	1905	2140
7/8-14	180	140	470	350	670	500	2318	2420	1895	2130
1-8	250	190	640	480	910	680	3440	3595	2815	3185
1-14	280	210	720	540	1020	760	3110	3250	2545	2885

## **SET-UP & ASSEMBLY**

**NOTE:** Determine right or left side of the Rake by viewing it from the rear. If instructions or parts lists call for hardened bolts, refer to the Cap Screw Torque Values page to identify.

1. Assemble the Rake or check the Rake for proper assembly and adjustment. Make sure that all bolts are tightened.
2. Attach the wheels with tires if they are not attached using the lug nuts furnished, and torque the mounting hardware to 85-95 ft./lbs. of torque. Check wheel bolts periodically thereafter.
3. Check tires and inflate to the recommended pressure for field use (205/75D15 - 25-30 PSI).
4. Lubricate the rake completely. (See Lubrication Chapter in this Manual.)
5. Rake tooth bolts must be torqued to 40 ft./lbs. to help prevent excessive tooth breakage. See the set-up instructions for mounting procedure.

**NOTE: Re-torque rake tooth bolts after the first 100 acres. Check periodically thereafter.**



# TRANSPORTING

## TOWING ON HIGHWAY

Follow state and local regulations when towing farm equipment on public highways. Never tow the rake on a public highway at a speed greater than 20 mph (32 kph).

## REFLECTORS

Reflective decals are on the outer edges and sides of the rake for safety.

Front facing amber



Side facing amber

Rear red reflective



# PREPARING FOR OPERATION

## ADJUSTMENTS

There are multiple settings available for adjusting the hitch as shown in the picture.

1. Adjust the tractor hitch (if possible) so that it is 13 to 17 inches above ground.
2. Attach the rake to tractor with a 1" **hitch pin that has a safety locking device.**
3. The rake clevis hitch should be adjusted so the main rake beams are level or parallel to the ground when in the raking position.
4. After adjusting, pull the rake forward and hydraulically lower the rake beams to check for levelness.
5. Remove the weight from the lift jack and place the jack in the storage position on the top of the pole.

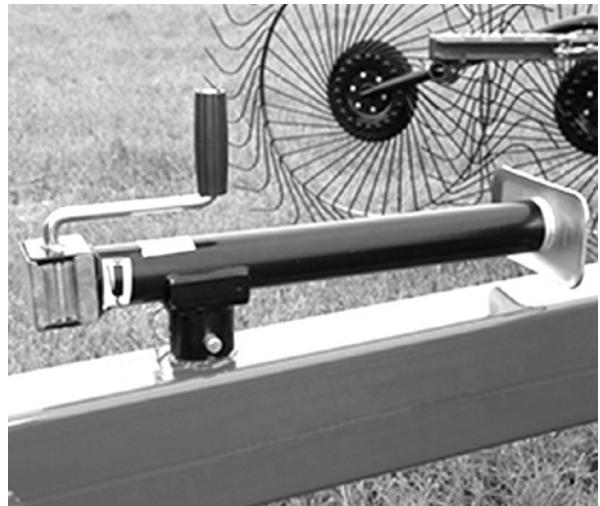
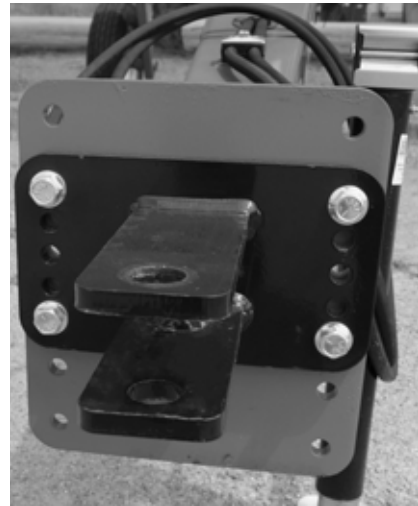

6. Connect the 2 hydraulic hoses to the tractor for raising and lowering the rake arms. Operate the tractor valve to fill the hydraulic lines and operate the cylinders. Add hydraulic fluid to the tractor system as required.

**NOTE: The tractor must have a minimum of 1,875 p.s.i. and 8 gallons of flow per minute to operate the rake properly.**

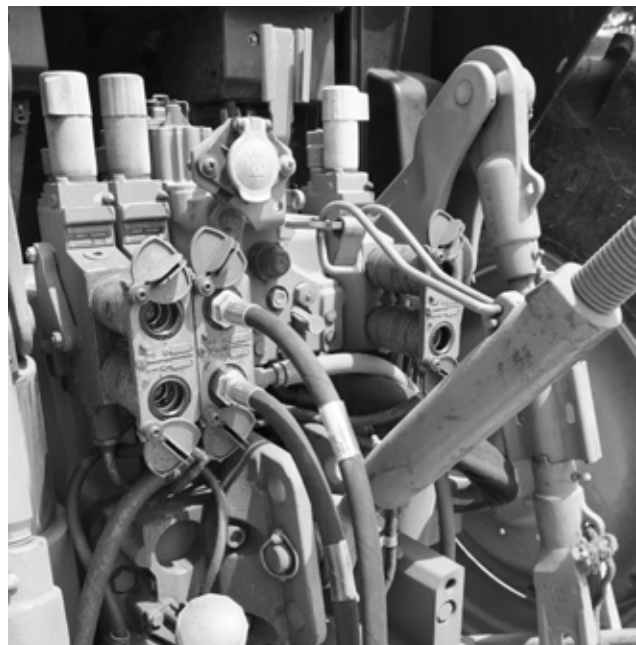

# OPERATION & ADJUSTMENTS

## EMERGENCY SHUTDOWN

Stop the tractor engine, remove ignition key, and allow all mechanisms to stop before cleaning or working on the machine.

## IMPORTANT:

Retighten all bolts on the rake after 100 acres as bolts can loosen up on new machinery.

Re-torque rake tooth bolts after first 100 acres. Check periodically thereafter.

## USE THE FOLLOWING STEPS BELOW TO SET YOUR RAKING WIDTH

### RAKING WIDTH ADJUSTMENT

There are multiple width adjustments on the wheel rake beam for setting the finish windrow width. Place the pin in the hole to the windrow size after you have manually swung the rake arms to a finish rake wheel opening that you would like. Each rake beam angle can be adjusted independently.

Keep in mind that the shallower of an angle that the raking width is, the less stress and wear there is on the rake wheels, easier over the ground.

Try to keep the front rake wheels no wider than the crop if possible while keeping the desired rear windrow width.

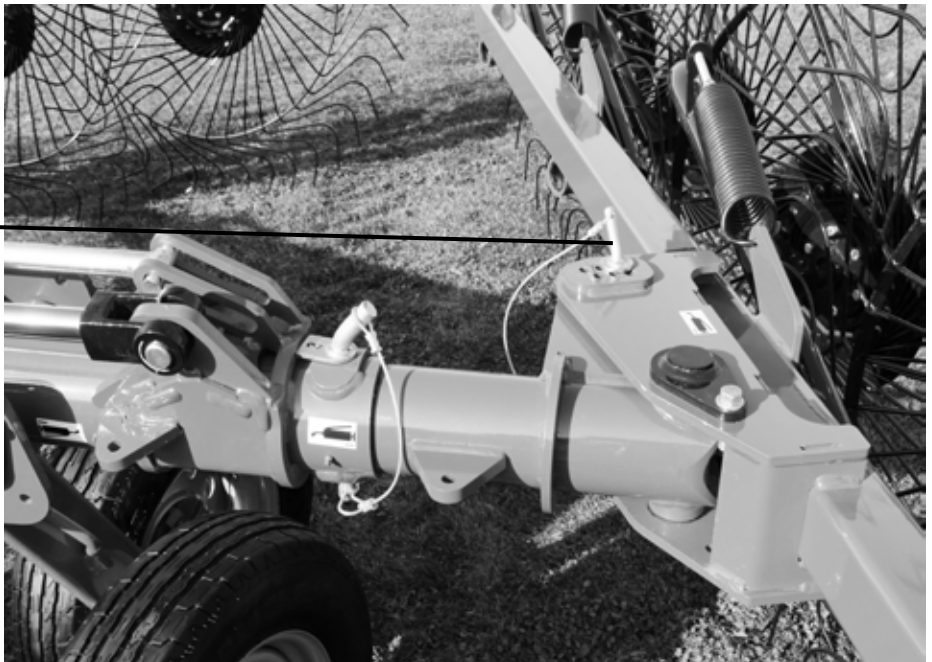

### WINDROW WIDTH ADJUSTMENT

There are (2) holes in each rake arm available to set the windrow width adjustment for the rake arm distance. Follow the steps below:

1. Raise the rake beam so that the rake wheels are slightly off the ground.
2. Remove the pin and hair pin clip from the rake arm.
3. Manually slide the round beam to the desired position.
4. Reinsert the pin in the desired hole and replace the hair pin clip.

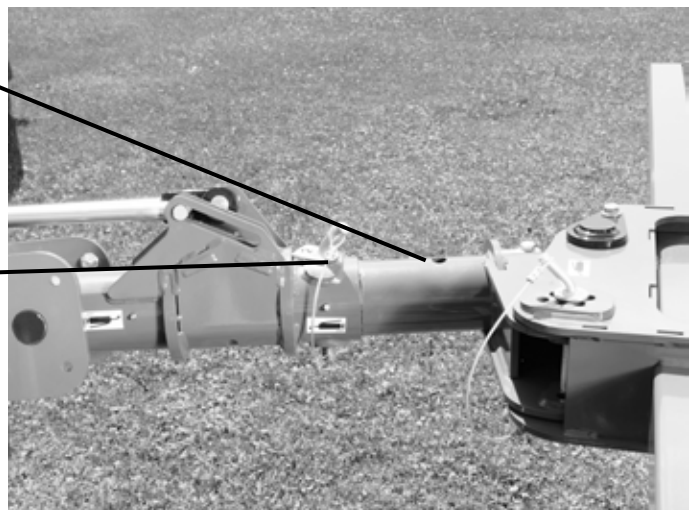

# OPERATION & ADJUSTMENTS

## FLOATATION

### Rake Arm/Wheels

Floataction pressure of the rake wheels can be adjusted by adjusting the pressure rod assembly.

- Hydraulically raise the rake beams so they are off the ground approximately 6”.
- Loosen the lock ring and turn the rod collar to show more threads. This increases the down pressure of the rake wheels.
- Showing fewer showing decreases the down pressure of the rake wheels.
- Hand-tighten the lock ring once the proper adjustment has been made.



### Rake Wheel

Rake wheel floataction pressure on each rake wheel is factory set for the correct spring pressure with the Hex/Jam nut. If more or less rake wheel pressure is needed other than what is available on the lock ring, adjust the Hex/Jam nut combination.



**NOTE: Re-torque rake tooth bolts/nuts after the first 100 acres to 40 ft./lbs. Check periodically thereafter.**

## **OPTIONAL EQUIPMENT**

### **CENTER KICKER WHEEL**

An optional center kicker wheel is available. If the hay is laying out flat, the extra wheel allows you to move the hay lying in the center of the rake out of the stubble for easier pick-up. The center kicker wheel will raise and lower when the hydraulics are activated. The shut-off valve should also be locked/turned off when transporting or when it is not in use.

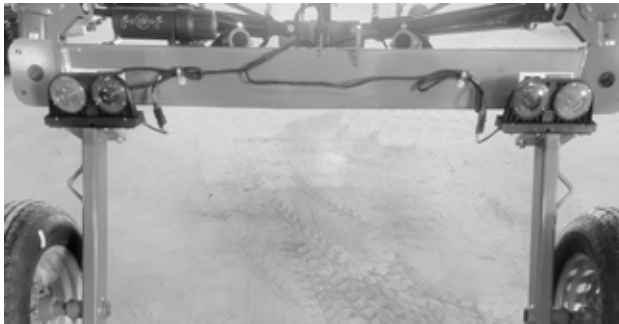

### **HIGHWAY LIGHTING**

A Highway Lighting Kit, shown in the picture on the left, is available. It includes tail lights and turn signals.

### **TURNBUCKLE ADJUSTMENT**

The Turnbuckle Kit includes two turnbuckles that can be installed on each rake arm to adjust the windrow raking width to the desired windrow width hole.

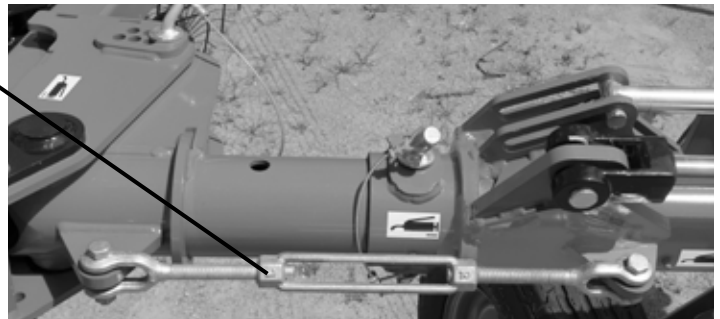

### **ONE-SIDED RAKING**

Raking with one side can be accomplished with the optional One-Side Raking Kit. The kit allows you to close the valve on either side when the rake is in the transport position. Lower the remaining side for one-sided raking. (Note: When the handle is in line with the hose, it is open.)



# LUBRICATION

Become familiar with all lubrication points and establish a routine to ensure complete lubrication of the rake.

## GENERAL INFORMATION

**IMPORTANT:** Catch and dispose of fluid per local waste disposal regulations whenever service is performed on hydraulic components, valves, cylinders, hoses, etc.

## WHEEL BEARING LUBRICATION, CLEAN & REPACK INSTRUCTIONS

Grease wheel bearings as needed depending on amount of travel.

Annually disassemble and clean parts in a solvent. Pack bearings with a high grade grease. Reassemble, and tighten nut until a slight drag is felt when wheel is turned. Back nut off and insert cotter pin into the first hole that you see as you back the nut off. Bend the cotter pin over and reinstall cap.

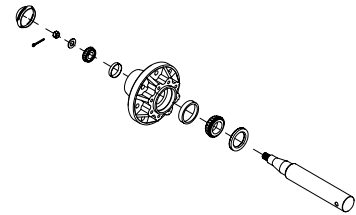

## GREASE FITTINGS

There are numerous grease fittings on the rake as illustrated below. Lubricating properly and often enough will prolong the life of your rake. Grease daily during normal use, before and after storage, and after power washing. Use a good grade of high-quality grease. Make sure that grease comes out around the shaft on sleeve-type bearings. Wipe off excessive grease to prevent accumulation of chaff or grit around the bearing. Replace any missing or plugged grease fittings.

## LOCATION

Listed and shown are the description of location and number of grease fittings.



1 zerk on jack



1 zerk on each of the pivot points

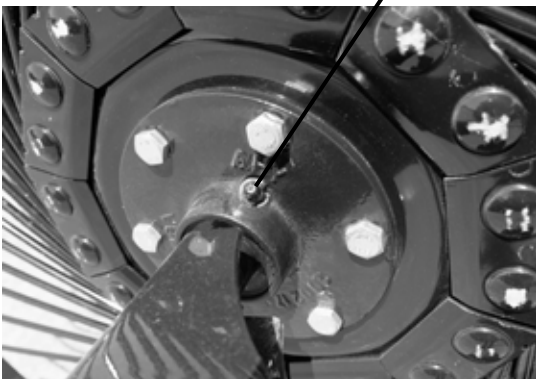

1 zerk on each rake wheel hub assembly



# LUBRICATION

2 zerks on the front  
of RH lift arm  
10 & 12-wheel only

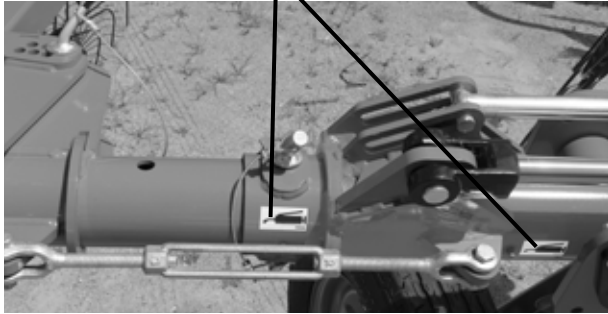

2 zerks on the front  
of LH lift arm  
10 & 12-wheel only

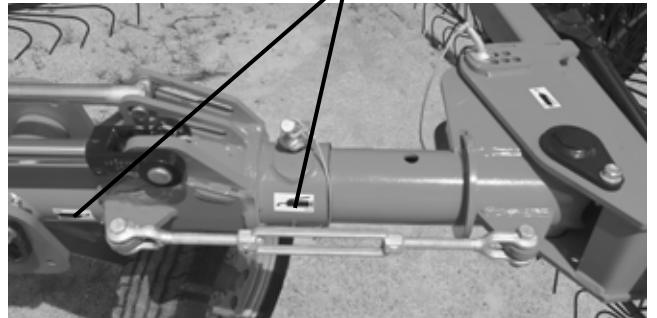

2 zerks on the rear  
of RH lift arm  
10 & 12-wheel only

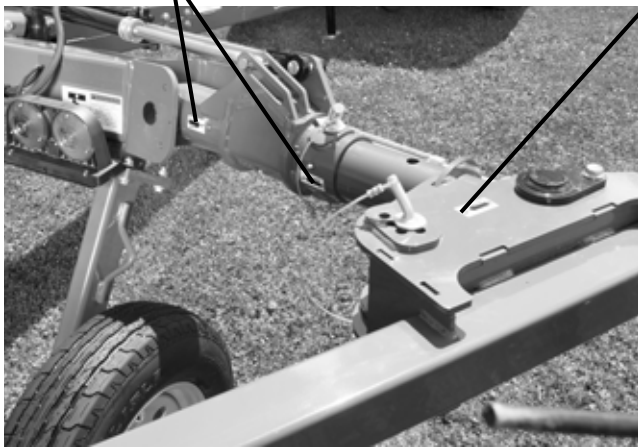

1 zerk on  
each beam  
pivot point

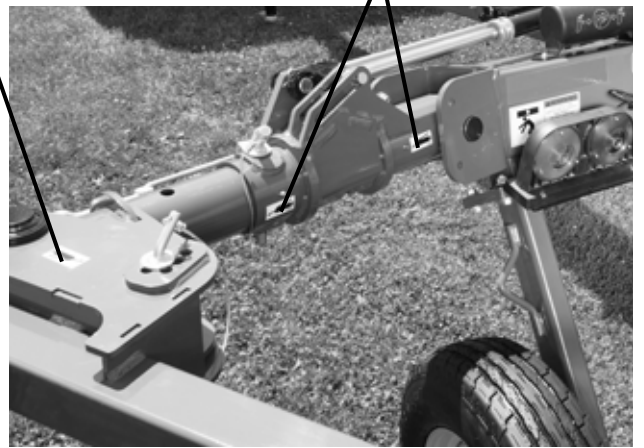

2 zerks on the front  
of LH lift arm  
10 & 12-wheel only



Zerks on each  
rake arm pivot  
point

## DECAL LOCATION

Your H&S rake was manufactured with operator safety in mind. Located on the rake are various decals to aid in operation and warn of caution areas. Pay close attention to all decals.



**DO NOT REMOVE ANY OF THESE DECALS. IF DECALS ARE LOST, DAMAGED, OR IF CARTED WHEEL RAKE IS REPAINTED, REPLACE DECALS. REMEMBER: DECALS ARE FOR YOUR PROTECTION AND INFORMATION.**

Listed below are the decals on your rake.

<u>Part #</u>	<u>Quantity</u>	<u>Description</u>
311	1	Patent Decal
1906C	2	Stay Clear
2700A	6	Stay Clear of Rake
11599	2	Do Not Go Near leaks
54033	1	U.S.A.
71188B	1	Jack Storage Position
72203A	1	Help Avoid Injury - Read and understand the operator's manual
94227	1	3210 Decal/Right
94229	1	3212 Decal/Right
91161	1	3210 Decal/Left
91176	1	3212 Decal/Left
90599	1	Action Rake Decal/Right
90603	1	Action Rake Decal/Left
82602	1	Crushing Hazard
82907L	1	Warning-Do Not Ride
84044	1	FEMA Decal
84045	1	H&S Since 1967
093020	AR	Grease Zerk
DCAMB	4	Amber Reflector
DCRED	2	Red Reflector



# DECAL LOCATION

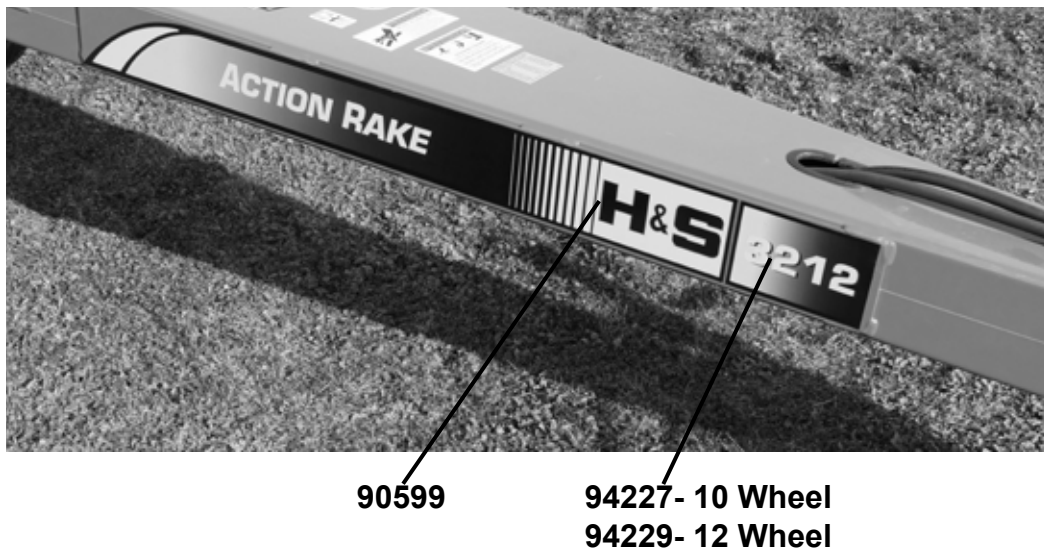
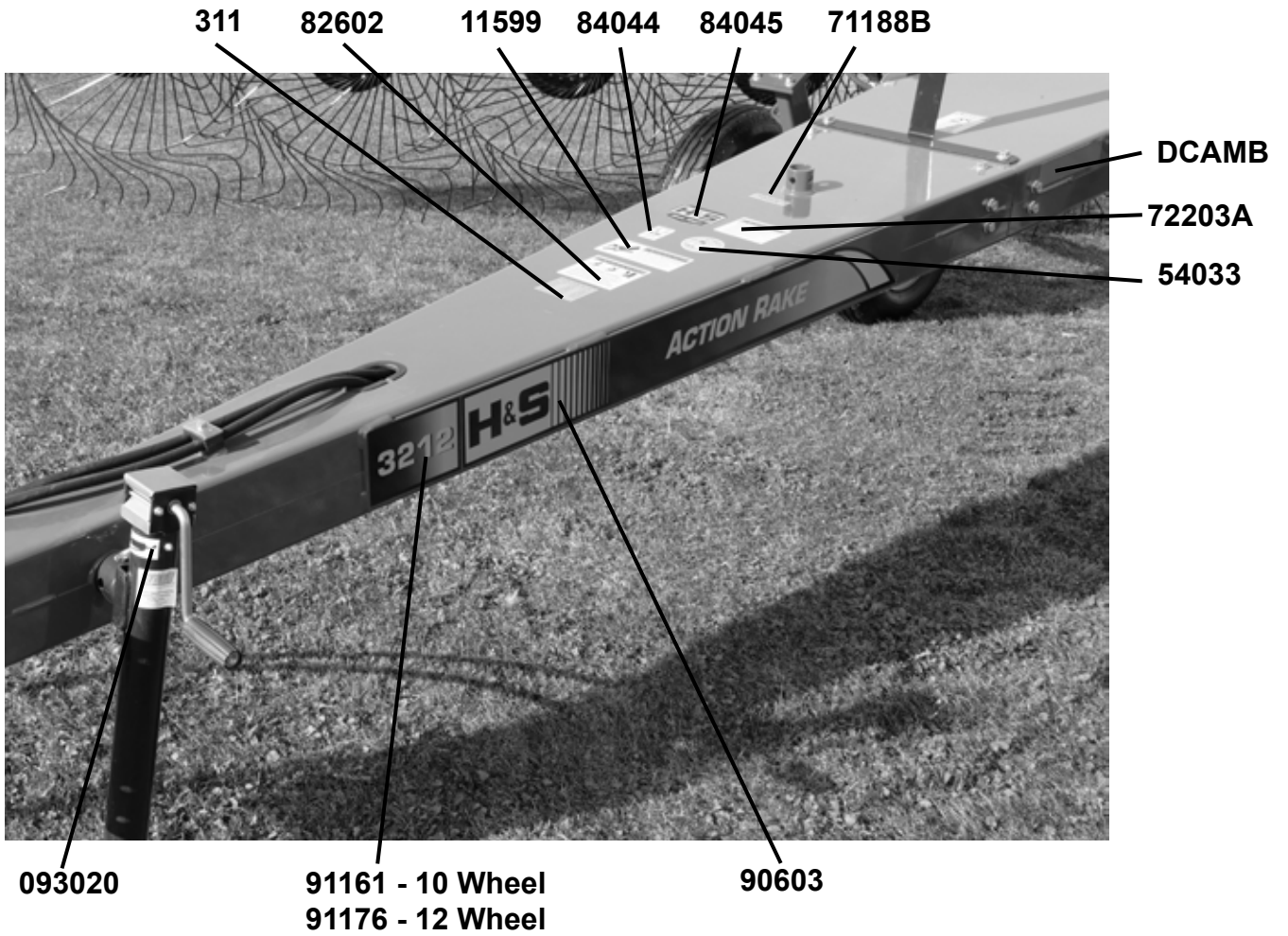

# DECAL LOCATION

11599

DCAMB

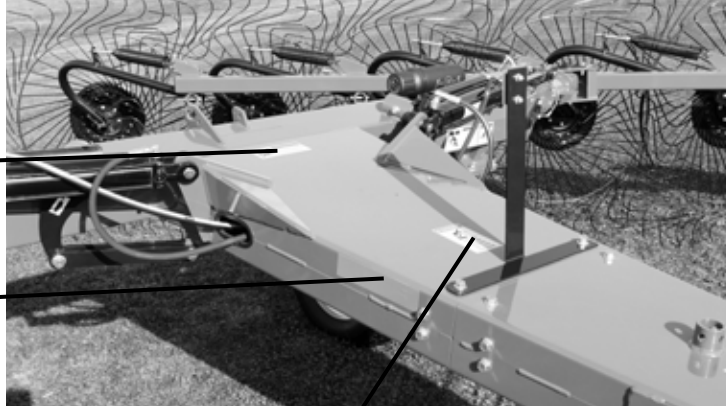

82907L

DCRED

2700A

093020

093020

093020

2700A

DCRED

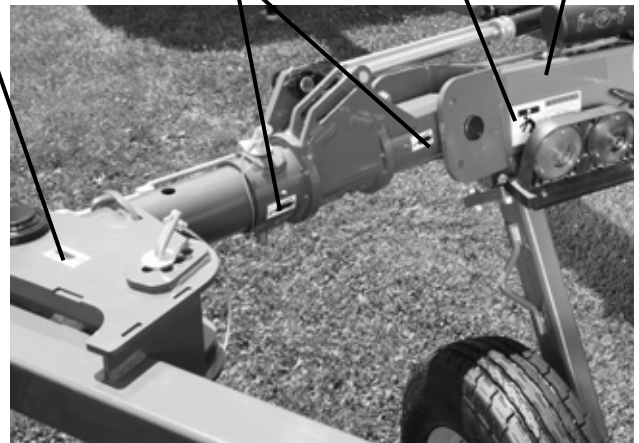
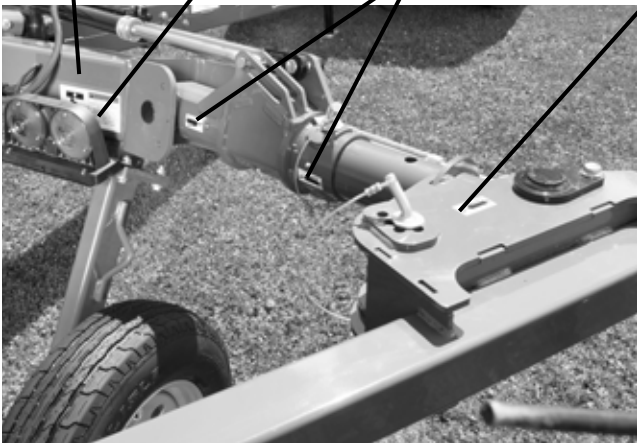

# DECAL LOCATION

Right & left-hand rake beams are the same decals.



**093020**  
Decal on  
each arm  
pivot

**2700A**

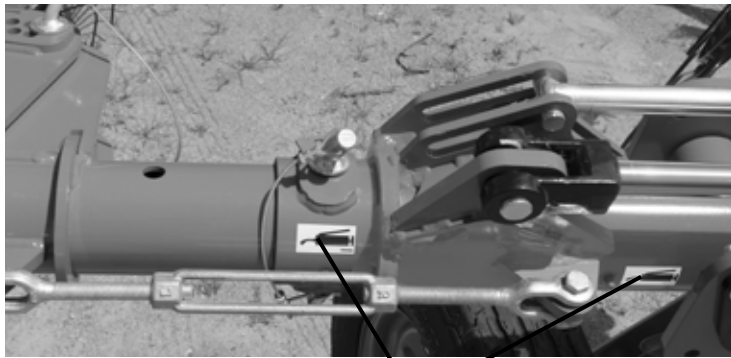

**093020**

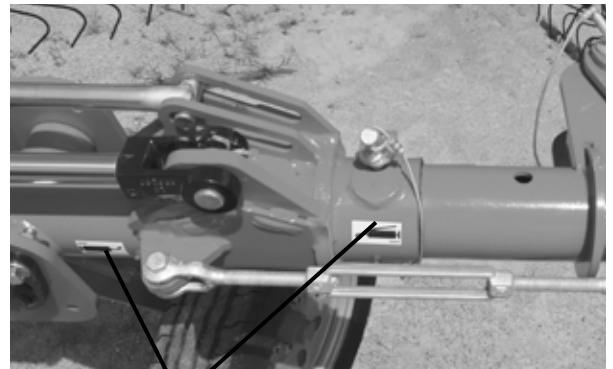

**093020**

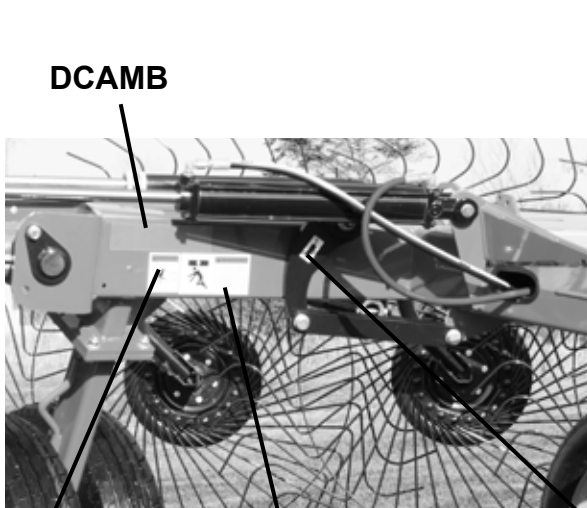

**DCAMB**

**1906C**

**2700A**

**093020**

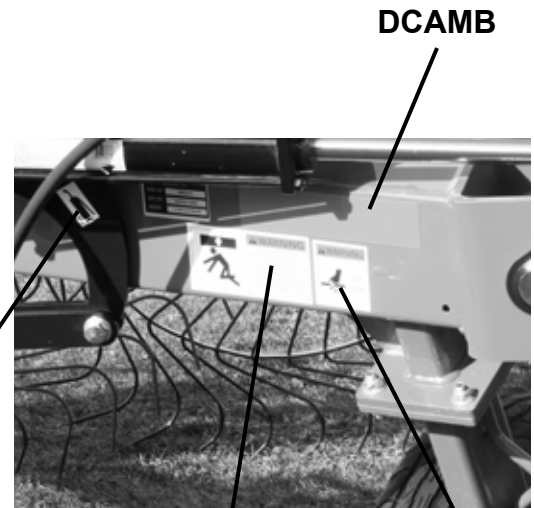

**DCAMB**

**2700A**

**1906C**

# TROUBLESHOOTING

**NOTE:** *This Troubleshooting Chapter presents problems, causes and suggested remedies beyond the extent of loose, worn or missing parts. It was developed with the understanding that the machine is in otherwise good operating condition.*



**WARNING:**

**MAKE SURE THAT THE TRACTOR IS SHUT OFF AND THE RAKE CANNOT MOVE BEFORE SERVICING THE RAKE. MAINTENANCE AND REPAIR SERVICE WORK TO BE PERFORMED BY A QUALIFIED SERVICE PERSON ONLY.**

PROBLEM	CAUSE	REMEDY
Rake lifting arms will not lower	Optional one-sided raking hydraulic valve is in closed position	Rotate optional one-sided raking hydraulic valve to open position
	Hydraulic coupler hoses not coupled to tractor properly	Couple hoses to tractor
Rake lifting arms will not raise	Not enough tractor hydraulic pressure	Replace tractor with tractor that has recommended hydraulics
	Hydraulic coupler not coupled to tractor properly	Couple hose to tractor
	Tractor hydraulics do not have sufficient pressure	Tractor should have at least 1,875 psi to operate rake & 7 GPM's
	Optional one-sided raking hydraulic valve is in closed position	Rotate optional one-sided raking hydraulic valve to open position
Center Kicker Wheel will not raise or lower	Hydraulic valve is shut off	Turn hydraulic valve on
Rake wheels leaving hay on the ground	Not enough rake wheel down pressure	Adjust down pressure per Operation and Adjustment Chapter
Rake wheels digging dirt/ash content	Too much rake wheel down pressure	Adjust down pressure to lighten rake wheel pressure per Operation and Adjustment Chapter
Finished windrow too wide for baler	Rake windrow width adjusted too wide.	Adjust rake windrow width per Operation and Adjustment Chapter
Hay carrying around on the last set of rake wheels	Rake windrow width adjusted too narrow.	Adjust rake windrow width per Operation and Adjustment Chapter
Baler is not picking up the hay that wasn't raked between the rear rake wheels	No center kicker wheel installed on rake to disturb the crop	Install center kicker wheel assembly







# **H&S MFG. CO.**

products approved

for the

## **FEMA SEAL OF QUALITY**



Manufactured By:

**H&S MANUFACTURING CO., INC.**

2608 S. HUME AVE. MARSHFIELD, WI 54449

(715) 387-3414 | [hsmfgco.com](http://hsmfgco.com)

