

CONTENTS

Warranty	1
Manufacturer's Statement.	2
Warranty Registration Form	3
Dealer Pre-Delivery Checklist.	5
Dealer Delivery Checklist.	7
Safety Information - Be Alert Symbol.	9
Safety Information - Explanation of Safety Signs.	8
Safety Information - Danger Warning Signs.	11-12
Safety Information - Warning - Owner Must Read and Understand.	13
Safety Information - Warning Emergency Stop.	14
Cap Screw Torque Values.	15
Set-Up & Assembly.	16
Transporting.	17
Preparing for Operation.	18-20
Operation.	21-24
Adjustments.	25-27
Service.	28-29
Optional Features & Accessories.	30
Lubrication Guide.	31-33
Decal Location & Identification.	34-39
Service Notes.	40

H&S WARRANTY

H&S Manufacturing Co., Inc. ("H&S") warrants this product to be free from defect in material and workmanship. Except as noted below, this warranty term is twelve (12) months on labor, and twenty-four (24) months on parts from the date of delivery of the product to the original purchaser by an authorized H&S dealer. Under this warranty, H&S will repair or replace, at its option, any covered part which is found to be defective in material or workmanship during the applicable warranty term. In no case will the covered repair cost of a part or parts exceed the replacement cost of that part. Warranty service must be performed by H&S or a dealer authorized by H&S to sell and/or service the product involved, which will use only new or remanufactured parts or components furnished by H&S. This warranty includes approved parts and labor to fix the product but does not include, and the purchaser is responsible for, any service call and/or transportation of the product to and from the dealer's place of business, for any premium charged for overtime labor requested by the purchaser, and for any service work not directly related to any defect covered under this warranty. This warranty includes only those components of the product manufactured by H&S. Warranty for any component not manufactured by H&S including, but not limited to, engines, batteries, tires, rims, hydraulic motors, pumps, etc. are covered by the warranty, if any, provided separately by their respective manufacturers.

This warranty in all its parts, is extended solely to the original purchaser of the product, is terminated upon any subsequent transfer or sale from or by the original purchaser and extends no third party benefits or rights whatsoever.

The warranty term for any product used in any commercial, custom, for hire or rental application, is limited to six (6) months from the date of delivery of the product to the original purchaser or the first day of service, whichever comes first, by an authorized H&S dealer.

For commercial, custom for hire, or rental application, warranty is limited to 6 months from the date of delivery to the original purchaser, or the first day in service, whichever is earlier.

This warranty does not include: (1) Any product that has been altered or modified in ways not approved by H&S; (2) Depreciation or damage caused by normal wear, use for which the product was not designed, misuse, improper or insufficient maintenance, improper operation, accident or failure to follow the product Operator's Manual recommendations and product decal recommendations; (3) Normal maintenance parts and service; (4) Repairs made with parts other than those available from H&S or performed by anyone other than H&S or a dealer authorized by H&S to sell and/or service the product involved.

To secure warranty service the purchaser must report the product defect to a dealer authorized by H&S to sell and/or service the product involved within the applicable warranty term together with evidence of the warranty start date and make the product available to that dealer within a reasonable period of time.

THERE ARE NO WARRANTIES WHICH EXTEND BEYOND THE DESCRIPTION ON THE FACE OF THIS WARRANTY. H&S and the companies affiliated with it makes no warranties, representations, or promises, express or implied, as to the performance or freedom from defect of its products other than those set forth above and **NO IMPLIED WARRANTY OF MERCHANTABILITY, FITNESS OR FITNESS FOR A PARTICULAR PURPOSE IS MADE. IN NO EVENT WILL THE DEALER, H&S OR ANY COMPANY AFFILIATED WITH H&S BE LIABLE FOR INCIDENTAL OR CONSEQUENTIAL DAMAGES.** The **ONLY REMEDY** the purchaser has in connection with the breach of performance of any warranty on H&S products are those set forth above.

The selling dealer has no authority to make any representation or promise on behalf of H&S, or to modify the terms or limitations of this warranty in any way.

11/14/18

MANUFACTURER'S STATEMENT

Your New H&S Product has been manufactured of the finest quality materials and components. The performance you get from your machine is largely dependent upon how well you read and understand this manual and apply this knowledge. There is a right and a wrong way to do everything. Please do not assume that you know how to operate and maintain your Machine before reading this manual carefully. Keep this manual available for ready reference.

WARRANTY REGISTRATION

- ❖ Date of Purchase: _____
 - ❖ Purchaser Name: _____
 - ❖ Street Address: _____
 - ❖ City: _____
 - ❖ State: _____ Zip: _____
 - ❖ Phone Number: _____
 - ❖ E-mail Address: _____
 - ❖ Product: _____
 - ❖ Model Number: _____
 - ❖ Serial Number: _____
 - ❖ You have received the Operators Manual for this product. Yes _____ No _____
- Interested in receiving the H&S Newsletter? Yes _____ No _____
-

- ❖ Dealer Name: _____
- ❖ Street Address: _____
- ❖ City: _____
- ❖ State: _____ Zip: _____
- ❖ Signature: _____

❖ *All fields must be filled out to insure prompt notification of product and/or warranty updates.*

Please mail the completed WARRANTY REGISTRATION FORM to:
H&S Manufacturing Co., Inc.
2608 S. Hume Ave.
Marshfield, WI 54449

(Remove Copy At Perforation)

Intentionally Left Blank

H&S DEALER PRE-DELIVERY CHECKLIST

AFTER COMPLETION, DEALER SHOULD REMOVE AND RETAIN FOR RECORDS

After the Forage Box has been completely set up, check to be certain it is in correct operating order before delivering to the customer. The following is a list of points to inspect. Check off each item as you have made the proper adjustments and found the item operating satisfactorily.

- Forage Box was not damaged in shipment. Check for dents and loose or missing parts. Report damage immediately to H&S Manufacturing Co., Inc.
- Forage Box has been correctly assembled according to instructions in this manual.
- All bolts and fasteners are tight.
- All shields and guards are in place and secured.
- All grease fittings have been lubricated. Gearboxes are filled to proper levels. See Lubrication Chapter of this manual for details.
- Hoses and fittings if applicable, are properly attached and there are no visible leaks.
- All drive chains are adjusted to proper tension. See Adjustment Chapter of this manual.
- Decals are in place and legible.
- Connect the Forage Box to a tractor and attach the PTO and make sure that the PTO guards turns freely.
- Connect the lights to the tractor. Lights and wiring functioning properly.
- Run the Forage Box and make sure all components operate properly.
- Any hydraulics, if applicable, do not leak under pressure.

Model Number _____

Serial Number _____

Dealer's Name _____

Inspection Date _____

Signature of Pre-Delivery Inspector _____

(Remove Dealer File Copy At Perforation)

Intentionally Left Blank

H&S DEALER DELIVERY CHECKLIST

AFTER COMPLETION, DEALER SHOULD REMOVE AND RETAIN FOR RECORDS

This checklist that follows is an important reminder of valuable information that should be passed on to the customer at the time this Forage Box is delivered.

Check off each item as you explain it to the customer.

This delivery checklist, when properly filled out and signed, assures the customer that the pre-delivery service was satisfactorily performed.

- Explain to the customer that the pre-delivery inspection was made.
- Explain to the customer all the safety precautions they must exercise when operating this unit.
- Explain recommended loads for different types of materials.
- Explain to customer that regular lubrication is required for proper operation and long life of machine.
- Show customer the lubrication section of Owner's Manual.
- Give the customer Owner's Manual and make sure they read and understand all operating and service instructions.
- Have customer sign a completed "Warranty Registration" and mail it promptly.

Date Delivered _____

Dealer's Name _____

By _____

Signature of Original Buyer _____

Note: Warranty is not valid until warranty card is completed and returned to H&S Mfg. Co., Inc.

Intentionally Left Blank

SAFETY INFORMATION



**BE
ALERT!** **YOUR SAFETY
IS INVOLVED.**

THIS SYMBOL IS USED THROUGHOUT THIS BOOK WHENEVER YOUR PERSONAL SAFETY IS INVOLVED. TAKE TIME TO BE CAREFUL. REMEMBER: THE CAREFUL OPERATOR IS THE BEST OPERATOR. MOST ACCIDENTS ARE CAUSED BY HUMAN ERROR. CERTAIN PRECAUTIONS MUST BE OBSERVED TO PREVENT THE POSSIBILITY OF INJURY OR DAMAGE.

H&S MANUFACTURING CO., INC.

SAFETY INFORMATION

Keep signs in good condition. Immediately replace any missing or damaged signs.

RECOGNIZE SAFETY INFORMATION

This is the safety alert symbol. When you see this symbol on your machine or in this manual, be alert to the potential for personal injury.

Follow recommended precautions and safe operating practices.



UNDERSTAND SIGNAL WORDS

A signal word - DANGER, WARNING, or CAUTION - is used with the safety alert symbol. DANGER identifies the most serious hazards.

Safety signs with signal word DANGER or WARNING are typically near specific hazards.

General precautions are listed on CAUTION safety signs.



WARNING



CAUTION



CAUTION

FOLLOW SAFETY INSTRUCTIONS

Carefully read all safety messages in this manual, and all safety signs on your machine. Follow all recommended precautions and safe operating procedures.

OBSERVE MAXIMUM TRANSPORT SPEED

The maximum transport speed for this implement is 32 km/h (20 mph).

Some tractors are capable of operating at speeds that exceed the maximum transport speed of this implement. Regardless of the maximum speed capability of the tractor being used to tow this implement, do not exceed the implement's maximum transport speed.

Exceeding the implement's maximum transport speed can result in:

- * Loss of control of the tractor/implement combination
- * Reduced or no ability to stop during braking
- * Implement tire failure
- * Damage to the implement structure or its components

Use additional caution and reduce speed when towing under adverse surface conditions, when turning, and when on inclines.

Do not attempt transport if the fully loaded implement weighs more than 1.5 times the weight of the tractor.

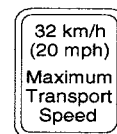

SAFETY INFORMATION

⚠ WARNING

HELP AVOID INJURY

- READ & UNDERSTAND THE OPERATORS MANUAL PROVIDED WITH THIS MACHINE. IF MISPLACED CALL H & S MANUFACTURING AT 715-387-3414 WITH MODEL AND SERIAL NUMBER.
- UNDERSTAND ALL SAFETY WARNINGS AND FUNCTION OF CONTROLS.
- KEEP SAFETY DEVICES IN PLACE AND WORKING.
- KEEP YOURSELF AND OTHERS WELL CLEAR OF MOVING PARTS.
- DISCONNECT ALL POWER BEFORE SERVICING OR CLEANING THIS MACHINE.
- NEVER ENTER FORAGE BOX FOR CLEAN OUT OR REPAIR WITHOUT FOLLOWING THE STEPS OUTLINED IN THE OPERATOR'S MANUAL AND INSIDE THE MAIN SIDE SHIELD.
- DO NOT EXCEED 20 MPH

92412

⚠ WARNING

WHEN OPERATING FORAGE BOX AS A REAR UNLOAD, OPERATOR SHOULD REMAIN IN TRACTOR SEAT AND KEEP ALL OTHERS WELL CLEAR.

EMERGENCY STOP DOES NOT STOP FORAGE BOX WHEN BEING OPERATED AS A REAR UNLOAD.

1494Q



⚠ WARNING

DO NOT GO NEAR LEAKS

- High pressure oil easily punctures skin causing serious injury, gangrene or death.
- If injured, seek emergency medical help. Immediate surgery is required to remove oil.
- Do not use finger or skin to check for leaks.
- Lower load or relieve hydraulic pressure before loosening fittings.

11599

⚠ WARNING



KEEP CHILDREN AWAY AT ALL TIMES!

2495

⚠ DANGER



5896B

ROTATING DRIVELINE CONTACT CAN CAUSE DEATH

⚠ DANGER



KEEP OUT

DISENGAGE ALL POWER AND SHUT OFF TRACTOR ENGINE BEFORE ATTEMPTING TO ENTER OR CLEAN FORAGE BOX. FAILURE TO HEED THIS WARNING MAY RESULT IN PERSONAL INJURY OR DEATH

1494I



⚠ WARNING

STAY CLEAR OF EXTENSION WHEN RAISING OR LOWERING. FAILURE TO HEED THIS WARNING MAY RESULT IN PERSONAL INJURY OR DEATH. KEEP CLOTHING, YOURSELF AND OTHERS WELL CLEAR.

92706

⚠ WARNING

TO PREVENT SERIOUS INJURY OR DEATH NEVER OPERATE THIS UNIT UNLESS EMERGENCY STOP FUNCTIONS PROPERLY

5896C

⚠ WARNING



DO NOT REMOVE SHIELDS MOVING PARTS INSIDE

1494K

⚠ WARNING



DO NOT CLEAN OR WORK ON THIS MACHINE WITHOUT FIRST DISENGAGING POWER AND SHUTTING OFF TRACTOR ENGINE.

1494J

⚠ DANGER



MAXIMUM OPERATING SPEED 540 RPM

OVERSPEED CAN CAUSE SEVERE INJURY OR DEATH DO NOT OPERATE WITH-

- 1000 RPM TRACTOR PTO
- TRACTOR PTO ADAPTER

⚠ DANGER



MAINTAIN SAFE CLEARANCE FROM ELECTRICAL POWER LINES AND AVOID CONTACT WITH ANY ELECTRICALLY CHARGED CONDUCTOR.

CONTACT WITH ELECTRIC POWER SOURCES CAN RESULT IN ELECTRICAL SHOCK OR ELECTROCUTION.

FAILURE TO HEED THIS WARNING MAY RESULT IN SERIOUS INJURY OR DEATH.

1494P

⚠ DANGER



ROTATING DRIVELINE CONTACT CAN CAUSE DEATH KEEP AWAY!

DO NOT OPERATE WITHOUT-

- ALL DRIVELINE, TRACTOR AND EQUIPMENT SHIELDS IN PLACE.
- DRIVELINES SECURELY ATTACHED AT BOTH ENDS.
- DRIVELINE SHIELDS THAT TURN FREELY ON DRIVELINE.

1494L

SAFETY INFORMATION

	⚠ WARNING
	<p>DO NOT OPERATE THIS EQUIPMENT IF THIS DECAL IS EXPOSED. REPLACE SAFETY SHIELDS.</p> <p style="font-size: small;">1494A</p>

⚠ DANGER

<p>KEEP OUT</p> <p>DISENGAGE ALL POWER AND SHUT OFF TRACTOR ENGINE BEFORE ATTEMPTING TO ENTER OR CLEAN FORAGE BOX. FAILURE TO HEED THIS WARNING MAY RESULT IN PERSONAL INJURY OR DEATH</p> <p style="font-size: x-small;">1494I</p>

⚠ DANGER

<p>STAY CLEAR OF BEATER AND/OR CROSS CONVEYOR IF POWER SOURCE OR PTO IS RUNNING</p> <p>FAILURE TO HEED THIS WARNING MAY RESULT IN PERSONAL INJURY OR DEATH</p> <p>KEEP CLOTHING, YOURSELF AND OTHERS WELL CLEAR.</p> <p style="font-size: x-small;">1494H</p>

	⚠ DANGER
	<p>NEVER ENTER FORAGE BOX UNLESS THE FOLLOWING SAFETY PRECAUTIONS ARE FOLLOWED.</p> <p style="font-size: x-small;">1494F</p>

	⚠ DANGER
	<p>STAY CLEAR OF EXTENSION WHEN RAISING OR LOWERING</p> <p style="font-size: x-small;">12502A</p>

	⚠ WARNING
	<p>STAY CLEAR MOVING PARTS UNDER THIS AREA</p> <p style="font-size: x-small;">1494C</p>

	⚠ WARNING
	<p>DO NOT REMOVE SHIELDS MOVING PARTS INSIDE</p> <p style="font-size: x-small;">1494B</p>

	⚠ WARNING
	<p>EMERGENCY STOP CABLE FUNCTIONS ONLY WHEN FORAGE BOX IS BEING OPERATED AS A FRONT UNLOAD</p> <p style="font-size: x-small;">1494O</p>

TRACTORS:

This Operator's Manual uses the term "Tractor" when identifying the power source.



WARNING

TO PREVENT SERIOUS INJURY OR DEATH, NEVER OPERATE THIS UNIT UNLESS EMERGENCY STOP FUNCTIONS PROPERLY.

BEFORE YOU ATTEMPT TO OPERATE THIS EQUIPMENT, READ AND STUDY THE FOLLOWING INFORMATION. IN ADDITION, MAKE SURE THAT EVERY INDIVIDUAL WHO OPERATES OR WORKS WITH THIS EQUIPMENT, WHETHER FAMILY MEMBER OR EMPLOYEE, IS FAMILIAR WITH THESE SAFETY PRECAUTIONS. KNOW HOW TO STOP MACHINE BEFORE STARTING IT.

If the machine becomes clogged or for servicing, Stop the tractor engine, remove ignition key and allow all mechanisms to stop. Before cleaning or working on the machine, detach the PTO shaft and completely disengage the tractor hydraulics.

DO NOT attempt to perform maintenance or repair with tractor running, PTO and hydraulic hoses connected to the tractor.

DO NOT ALLOW PERSONNEL OTHER THAN THE QUALIFIED OPERATOR NEAR THE FORAGE BOX.

Be sure the Forage Box is clear of people, tools, and other objects before engaging PTO.

DO NOT allow minors to operate or be near the Forage Box.

Do not step over PTO shaft: Stay clear of PTO at all times.

DO NOT step up on the Forage Box at any time while in operation.

BEFORE starting tractor, be sure PTO shields turn freely and PTO is securely locked to tractor.

NEVER start the Forage Box until all guards and safety shields are secured in place.

STAY CLEAR of discharge conveyor opening when in operation.

Keep hands, feet, and clothing away from all moving parts when the Forage Box is in operation.

Loose or floppy clothing should not be worn by the operator.

Never operate the Forage Box with a PTO speed greater than the recommended PTO RPM.

STAY CLEAR of hydraulic lines. They may be under extreme pressure or heat.

NEVER manually feed material into the beaters.

DO NOT clean, adjust, or lubricate the machine when any part is in operation.

CHECK frequently to be assured that the emergency stop mechanism is in proper operating condition.

CAUTION - Beware of low electrical wires.

NEVER hook up 1000 RPM tractor to the Forage Box.

STAY CLEAR of rear of Forage Box at all times.

H&S Mfg. Co. always takes the operator and their safety into consideration and guards exposed moving parts for their protection. However, some areas cannot be guarded or shielded in order to assure proper operation. In addition, the Operator's Manual and decals on the Forage Box itself warn you of further danger and should be read and observed closely.

Study The Above Safety Rules
ATTENTION - BE ALERT - YOUR SAFETY IS INVOLVED

SAFETY INFORMATION



WARNING

TO PREVENT SERIOUS INJURY OR DEATH, NEVER OPERATE THIS UNIT UNLESS EMERGENCY STOP FUNCTIONS PROPERLY

EMERGENCY STOP

1. In case of an emergency, pulling the trip cables, pushing the stop panel rearward, or disengaging the lever will stop cross-conveyor, beaters, and main apron.
2. Activating the emergency stop only stops box functions. The PTO shaft will continue to rotate.
3. Keep excessive slack out of trip cables.
4. Trip emergency stop occasionally, and when starting the unit after periods of storage, to ensure proper function.
5. To reset, move the lever clockwise to engage position.



! WARNING

WHEN OPERATING FORAGE BOX AS A REAR UNLOAD, OPERATOR SHOULD REMAIN IN TRACTOR SEAT AND KEEP ALL OTHERS WELL CLEAR.

EMERGENCY STOP DOES NOT STOP FORAGE BOX WHEN BEING OPERATED AS A REAR UNLOAD.

1494Q

CAP SCREW TORQUE VALUES

The specifications below are the torque values for fasteners as it adheres to the SAE torque value standards. All fasteners should be torqued to the proper values found in the figures below unless otherwise specified by the engineering drawing.

Lubed torque would be any fastener that has grease, liquid Loctite, oil, etc. on the threads.

Dry torque would be any fastener which has threads that are clean and dry and do not have any liquid Loctite or grease on them.

Hex Head Fasteners

The figure shown below shows how to determine what grade a fastener is.

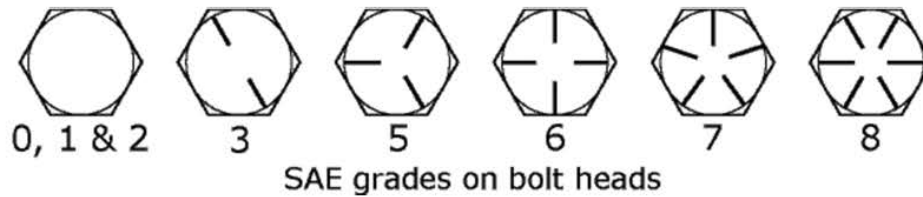

SUGGESTED ASSEMBLY TORQUE VALUES							WORKING TORQUE			
Diam & Thrds Per Inch	SAE GRADE 2 -6"		SAE GRADE 5		SAE GRADE 8		18-8 SS	316 SS	BRASS	SILICON BRONZE
	Dry FT. LB.	LUB FT. LB.	Dry FT. LB.	LUB FT. LB.	Dry FT.LB.	LUB FT. LB.	IN LBS	IN LBS	IN LBS	IN LBS
1/4-20	5.5	4.2	8	6.3	12	9	75.2	78.8	61.5	68.6
1/4-28	6.3	4.7	10	7.2	14	10	94.0	99.0	77.0	87.0
5/16-18	11	8	17	13	24	18	132	138	107	123
5/16-24	12	9	19	14	27	20	142	147	116	131
3/8-16	20	15	30	23	45	35	236	247	192	219
3/8-24	23	17	35	25	50	35	259	271	212	240
7/16-14	32	24	50	35	70	50	376	393	317	349
7/16-20	36	27	55	40	80	60	400	418	327	371
1/2-13	50	35	75	55	110	80	517	542	422	480
1/2-20	55	40	85	65	120	90	541	565	443	502
9/16-12	70	55	110	80	150	110	682	713	558	632
9/16-18	80	60	120	90	170	130	752	787	615	697
5/8-11	100	75	150	110	210	160	1110	1160	907	1030
5/8-18	110	85	170	130	240	180	1244	1301	1016	1154
3/4-10	175	130	260	200	380	280	1530	1582	1249	1416
3/4-16	200	140	300	220	420	310	1490	1558	1220	1382
7/8-9	170	125	430	320	600	450	2328	2430	1905	2140
7/8-14	180	140	470	350	670	500	2318	2420	1895	2130
1-8	250	190	640	480	910	680	3440	3595	2815	3185
1-14	280	210	720	540	1020	760	3110	3250	2545	2885

SET-UP & ASSEMBLY



WARNING: Some photographs used in the following pages show guards or shields removed for clarification. Never operate machine until these guards or shields are in proper operating position.

NOTE: Determine right or left side of the forage box by viewing it from the rear. If instructions or parts lists call for hardened bolts, refer to the Cap Screw Torque Values page to identify.

1. Check the Forage Box for proper assembly and adjustment. Make sure that all bolts are tightened.
2. Properly lubricate the Forage Box before operating. Refer to Lubrication Section of this Operator's Manual for locations.
3. **GEARBOXES:**
Main Apron Drive Gearbox: Keep the main apron gearbox filled to the oil level plug in cover of gearbox using 85W140 lubricant.

Beater Drive Gearbox: Keep the beater drive gearbox filled to the center of the shafts. Use 80W90 lubricant.
4. Check all lights to make sure that they are functioning properly.

TRANSPORTING

TRANSPORT LIGHTING & REFLECTORS

Transport lighting is standard on all Models. The lighting system is to be connected to the 7-pin power receptacle (per SAEJ560B) on your tractor. If your tractor is not equipped with the proper receptacle, see your tractor dealer for details. Red reflective safety decals are on the rear of the box for safety.



WHEN TRANSPORTING ON THE HIGHWAY OR ROADS, PLACE SMV SIGN IN SOCKET PROVIDED AND REGULARLY CLEAN THE REFLECTIVE TAPE AT THE REAR OF THE FORAGE BOX.

NOTE: Obey all state and local laws concerning towed equipment on public roads.

TOWING ON HIGHWAY

To view beyond the back of the Forage Box when transporting the unit on a public highway, consider obtaining and installing a rearview mirror on your tractor with a wide load mounting bracket.

PREPARING FOR OPERATION

Check over entire unit carefully before first operation. Tighten bolts, set screws, and chains which may have come loose in handling. Lubricate as explained in the Lubrication Guide. Successful operation will be achieved by periodic adjustments and experience of the operator. Make sure to read and understand all adjustments.

TRACTION CONNECTIONS

Front Telescoping PTO Drive

After attaching the Forage Box to the tractor drawbar with a pin and locking clip, attach the PTO to the tractor PTO shaft, locking it into position. Maintain correct distance between tractor drawbar hitch, tractor PTO, and the universal joint at front of unit. This is necessary to prevent overextending the universal joint shaft.

1. Maintain a straight alignment between the Forage Box and the tractor.
2. Maintain a distance of 6"- 12" between the top of the tractor drawbar and the center of the tractor PTO. An 8" distance is standard.

After the correct distance is obtained, depress the locking collar against the spring tension and slide the yoke onto tractor PTO shaft. Release the locking collar and move the yoke ahead or back until the lock engages into the groove on the shaft.

NOTE: Do NOT attempt to use a hammer to help in attaching the PTO drive connection.

The tractor drawbar should be adjusted in relation to the tractor PTO shaft as follows:

1. Hitch point of drawbar 14 inches behind tractor PTO shaft.
2. Hitch point of drawbar at least 8 inches, but not more than 14 inches below PTO shaft.
3. Hitch point of drawbar at least 13 inches, but not more than 22 inches above ground level.
4. When unloading, keep the hitch point of drawbar and PTO shaft in a straight line to the Forage Box. Having PTO at an angle will result in a pounding noise and damage to U joints and the safety clutch.

IMPORANT! DO NOT operate unless 2" minimum extension is maintained.

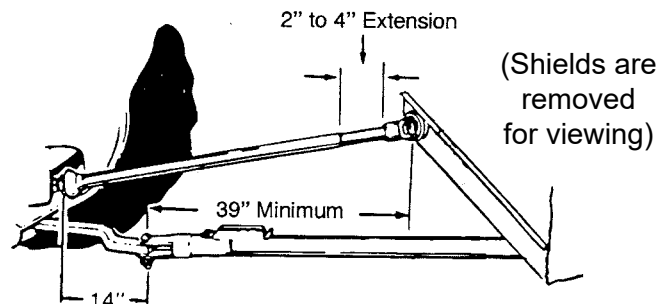

The telescoping PTO drive is designed to rotate freely inside the drive shield tubes. Lower the spring assist cross-conveyor extension. Or, if you have the optional hydraulic cylinder kit for the extension, connect the (2) hoses from the cylinder to the tractor remote and lower the extension.

Run the unloading mechanism for several minutes. This will serve as a break-in and as a check that all parts are assembled and lubricated properly.

After you have run the Forage Box for several minutes, check the main apron chains again for proper adjustment, as paint may initially come off the apron chains and chains may loosen. The main apron chains must be taken up evenly before you use the forage box. Check again after the first few loads. The main aprons should be at proper tension at all times. See [Adjustment Section](#) for details.

PREPARING FOR OPERATION

The Power Take Off Shaft from tractor to box should not be connected for road travel or field operation. Damage may result to the PTO Shaft. A convenient hanger is provided to hold PTO shaft during the time it is not being used to unload.



Front Unload Hydraulic Drive

After attaching the Forage Box to the tractor drawbar with a pin and locking clip, attach the (2) hydraulic hoses from the hydraulic drive motor to the tractor couplers.

Lower the spring assist cross-conveyor extension, or if you have the optional hydraulic cylinder kit for the extension, connect the (2) hoses from the cylinder to the tractor remote and lower the extension.

Engage the hydraulic lever for the hydraulic drive motor into the detent position and run the Forage Box for several minutes. After the hydraulic lever has been disengaged, stop the tractor engine, remove ignition key and allow all mechanisms to stop. Check the main apron chains again for proper adjustment, as paint may initially come off the apron chains and chains may loosen. The main apron chains must be taken up evenly before you use the forage box. Check again after the first few loads. The main aprons should be at proper tension at all times. See the Adjustment Section for details.

Drive - Rear Unload

To operate this forage box as a Rear Unload, the following steps must be followed:

1. Remove the clip pin holding drive pin in front drive sprocket assembly. Rotate the pin counter-clockwise and remove from assembly.
2. Re-insert drive pin into rear drive sprocket. Rotate the pin clockwise until it locks into groove on peg. Secure with the clip pin.
3. Adjust rear chain tightener so there is slight deflection at the center of chain.

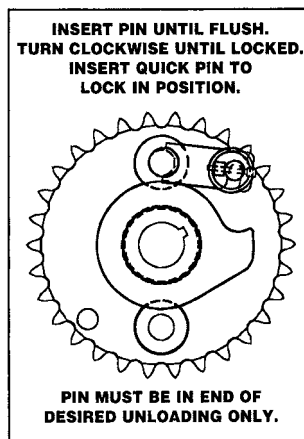
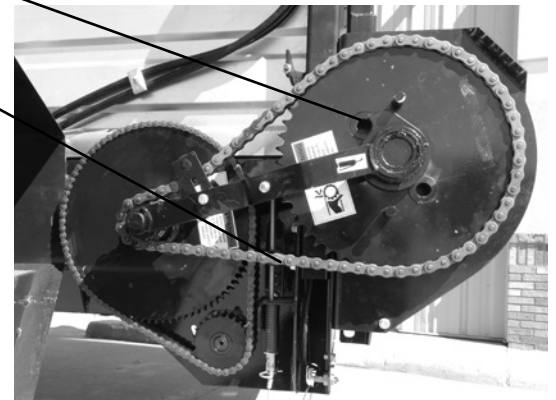
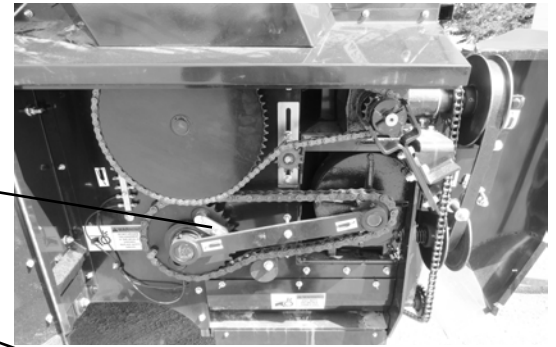

PREPARING FOR OPERATION

Rear Unload Door

Unlock the rear door locks located on the inside of the left and right hand rear drive shaft brackets. Latches lock against knurled gears on rear drive shaft to hold the door closed when operating the forage box as a rear unload. When the tractor hydraulics are activated and the rear drive shaft turns, knurled gears flip latches open to allow rear door to swing free. Upon completion of unloading, check the rear door to insure that latches are securely in place for next load.

CAUTION: Rear door locks should be locked in position only when using front unload. While operating rear unload, rear door locks **MUST** remain unlocked.



FAILURE TO UNLOCK REAR DOOR LOCKS WHEN THE FORAGE BOX IS BEING UNLOADED TO THE REAR WILL RESULT IN SEVERE DAMAGE TO THE FORAGE BOX.

OPERATION

GENERAL INFORMATION

Check entire Forage Box carefully before first operation. Tighten bolts and set screws that might have come loose during transport. Lubricate if needed as explained in the Lubrication Chapter in this manual.

EMERGENCY SHUTDOWN

In case of an emergency, pushing the emergency stop panel, emergency stop bar, or pulling the safety cable will stop cross conveyor, beaters, and main aprons. PTO will continue to rotate. If the Forage Box is plugged with material or a foreign object becomes lodged in the discharge area, disengage the PTO or tractor hydraulic lever. Stop the tractor engine, remove ignition key and allow all mechanisms to stop before cleaning or working on the machine. Trip emergency stop occasionally to ensure proper function.



Emergency Stop Panel

Emergency Stop Cable

Disengage Lever

CONTROLS & SAFETY EQUIPMENT

Forage Boxes are provided with several features for operator safety and convenience.

Guards & Shields

Whenever possible and without affecting the operation of the Forage Box guards, shields and/or hinged shields have been used on this equipment to protect potentially hazardous areas. In many places, decals are also provided to warn of potential dangers, as well as to display special operational procedures.

PTO Shields

Care must be taken to keep male and female driving elements well lubricated and free sliding. The shield surface must be kept dry, as dirt accumulation on them will quickly cause these units to bind and not rotate. If, at any time the shields do not turn freely, they should be checked to determine the cause, and repaired or cleared. **DO NOT STEP OVER PTO SHAFT. STAY CLEAR OF ROTATING PTO AT ALL TIMES. DO NOT OVEREXTEND PTO.**

Shown is the spring-loaded plastic guard which protects the operator from accidentally being exposed to the beater and apron at the discharge opening during operation of the Forage Box. Keep this guard in proper position at all times when operating forage box.



OPERATION

OPERATION OF FRONT UNLOAD FORAGE BOX

1. Park the Forage Box on level ground whenever possible during unloading. Lock tractor parking brake.
2. **PTO MODEL:** Connect the PTO to a tractor with a 540 PTO ONLY, locking securely in place as stated in the PREPARING FOR OPERATION SECTION.
HYDRAULIC DRIVE MODEL: Attach the (2) hydraulic hoses from the hydraulic drive motor to the tractor couplers.
3. Engage PTO or Hydraulic Lever to the detent position.

NOTE: PTO MODEL: Do NOT exceed the rated 540 RPM operating speed of the Forage Box

4. To engage cross conveyor INTERMITTENTLY, rotate clutch lever clockwise and hold with hand pressure. If hand pressure is removed, the cross conveyor will stop.
5. To engage the cross conveyor CONTINUOUSLY, rotate clutch lever clockwise until it locks in the engage position. Cross conveyor speed is controlled by the tractor RPM only.



PTO Model

6. Quickly engaging/disengaging beater lever will allow beaters to clear material a little at a time to avoid exceeding blower capacity. This single lever controls both beater engage/disengage and the speed of the main feeder aprons. **CAUTION: DO NOT ENGAGE BEATERS OR MAIN APRONS WHEN CROSS CONVEYOR IS FULL OF MATERIAL OR DAMAGE TO FORAGE BOX WILL RESULT.**

7. When beaters are clear of material, move control lever to apron speed position. Variable speed drive offers you a number of unloading speeds to choose from. Rotating the lever downward starts and gradually increases main apron speed. With experience and depending on the type of forage, you will be able to select a speed which will match your blower capacity. Unloading speed may also be varied by increasing or decreasing engine speed of tractor.

8. If it is necessary to trip the stop mechanism and disengage the Forage Box drive before the box is empty, restart unloading by engaging clutch lever.

9. Clean out position is for cleaning out the forage box at the end of the load.

10. When the Forage Box is empty, move control lever to disengage position. **AFTER UNLOADING, ALWAYS RETURN THE CONTROL LEVER TO THE NEUTRAL POSITION WITH PTO RUNNING.**

11. Disconnect the PTO or hydraulic hoses and place it in the convenient holder for field and road use.



OPERATION

Drive - Rear Unload

To operate this forage box as a Rear Unload, the following steps must be followed:

1. Remove the clip pin holding drive pin in front drive sprocket assembly. Rotate the pin counter-clockwise and remove from assembly.
2. Re-insert drive pin into rear drive sprocket. Rotate the pin clockwise until it locks into groove on peg. Secure with the clip pin.
3. Adjust rear chain tightener so there is slight deflection at the center of chain.

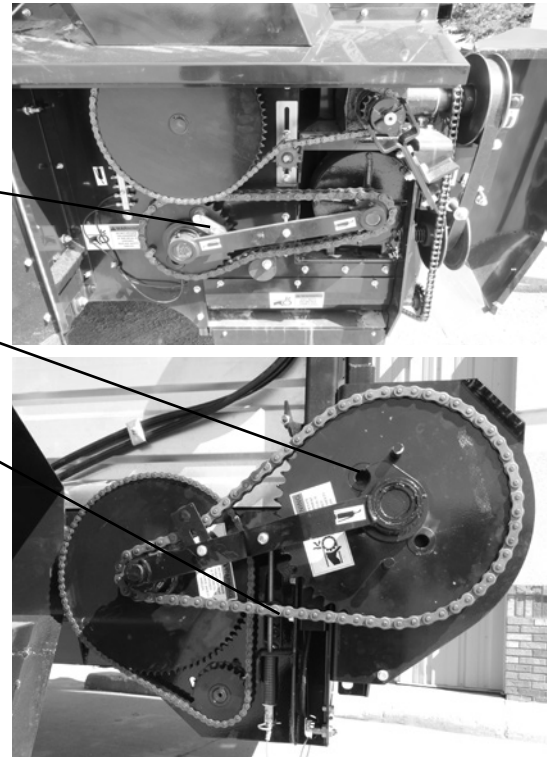
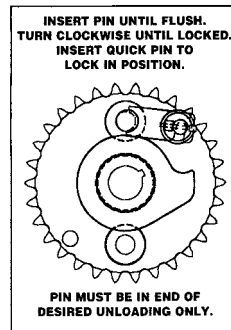

Rear Unload Door

Unlock the rear door locks located on the inside of the left and right-hand rear drive shaft brackets. Latches lock against knurled gears on rear drive shaft to hold the door closed when operating the forage box as a rear unload. When the tractor hydraulics are activated and the rear drive shaft turns, knurled gears flip latches open to allow rear door to swing free. Upon completion of unloading, check the rear door to ensure that latches are securely in place for next load.

CAUTION: Rear door locks should be locked in position only when using front unload. While operating rear unload, rear door locks **MUST** remain unlocked.



FAILURE TO UNLOCK REAR DOOR LOCKS WHEN THE FORAGE BOX IS BEING UNLOADED TO THE REAR WILL RESULT IN SEVERE DAMAGE TO THE FORAGE BOX.

OPERATION

BEATER CLUTCH

This single lever controls both beater engage/disengage and the speed of the main feeder aprons.

CAUTION: DO NOT ENGAGE BEATERS OR MAIN APRONS WHEN CROSS CONVEYOR IS FULL OF MATERIAL OR DAMAGE TO FORAGE BOX WILL RESULT. Prior to engaging beaters and main aprons, intermittently rotate emergency stop lever to the engage position to clear cross conveyor of all material. When beater control lever is engaged, the beaters and main aprons will start at the same time. **AFTER UNLOADING, ALWAYS RETURN THE CONTROL LEVER TO THE NEUTRAL POSITION WITH PTO RUNNING.**

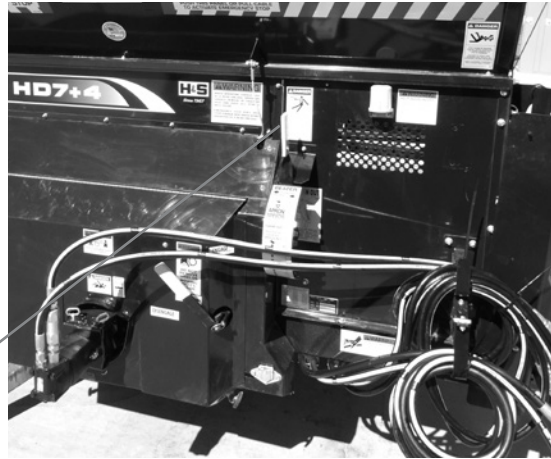

ADJUSTMENTS

OVERLOAD PROTECTION

Overload protection is achieved on the PTO driven Forage Box by the slipping of the main drive v-belts or the variable speed main apron belt. Stop all operation and follow the EMERGENCY SHUTDOWN PROCEDURE. Always determine the cause of failure.

BEATER CLUTCH ADJUSTMENT

Check the beater clutch periodically to ensure that the beaters are completely engaging or disengaging. The beater engage/disengage clutch is properly adjusted when there is 1/8" of clearance between the clutch jaw (B) and the engaging pin (A) when the control lever is in the disengage position. Basic adjustment can be made by positioning the adjustment nut at the end of the control rod.

Place the control arm tight against the nut and adjust the mounting bracket in the slotted holes on the unit until 1/8" is reached. Fine adjustment is made by adjusting the nut on the control rod.

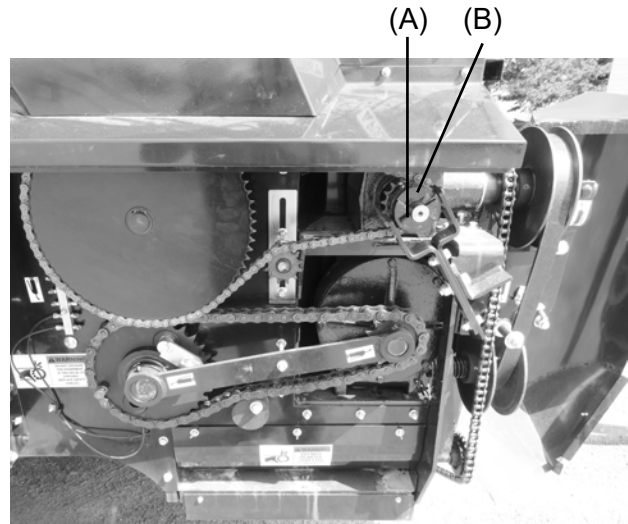

VARIABLE SPEED DRIVE BELT REPLACEMENT

If it becomes necessary to replace the variable speed drive belt, follow the steps listed below to remove worn belt:

1. Place the control lever in beater disengage position.
2. Open the upper sheaves so belt rests on the drive pins.
3. Remove the belt from the lower sheaves first, and then the upper sheaves.
4. Reverse the above steps when installing new belt.

VARIABLE SPEED BELT ADJUSTMENT

You should rarely have to adjust the variable speed drive belt. If, however, it becomes necessary to adjust the belt, follow the steps below:

1. Remove the belt as listed in the **BELT REPLACEMENT SECTION**.
2. Move the control lever to the highest apron speed position.
3. Check the upper sheaves, and if the base of sheaves are not tight together, it is necessary to adjust.
4. Remove the bolt from the control rod.
5. Slide the sheaves tight together, being sure that the control yoke is tight against the thrust bearing and sheaves.
6. Adjust the control rod so the hole in control yoke and rod align, then one additional turn.
7. Replace the bolt. Allow sufficient play when tightening so that the control rod pivots.
8. Place the control lever in beater disengage position and replace the belt.

ADJUSTMENTS

MAIN DRIVE BELT ADJUSTMENT

The unloading unit/Forage Box is driven by v-belts as a clutch system. Plugging the cross conveyor will cause the belts to slip. If the belts are constantly slipping, adjust the nut on the shifting rod a half turn at a time making sure not to overtighten the belt.

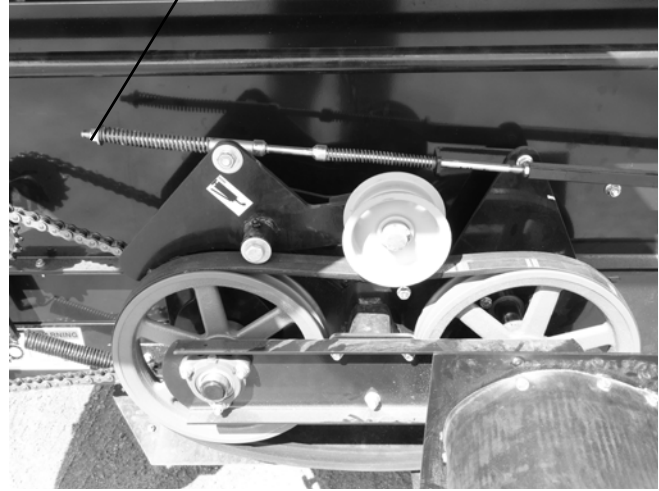

BEATER DRIVE CHAIN ADJUSTMENT

The beater drive chains have self-adjusting spring tighteners on them. The gearbox to the 1st beater and primary drive chain are tightened with a common spring, maintain a 1/16" gap between the coils by adjusting the I-bolt. DO NOT OVERTIGHTEN OR IT WILL CAUSE THE BEATERS TO TURN FROM THE TIGHTNESS OF THE CHAIN. The 2nd and 3rd beater springs should have a 1/16" gap between the coils. When the gap is less, check the condition of the chains, replace or remove a link, offset link, or replace the spring.

DRIVE CHAIN IDLERS

Drive Chain Idler - Front Unload

A chain tightener is provided to adjust the tension on the roller chain between the gearbox drive sprocket and the main apron drive shaft. The chain is properly adjusted when there is a slight deflection at the center of the chain.

NOTE: *If an idler fails to maintain proper tension, replace the worn chain.*

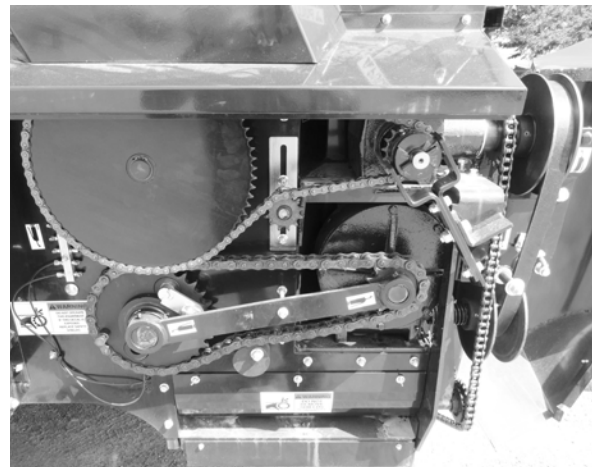

ADJUSTMENTS

CROSS CONVEYOR ADJUSTMENT

Proper tension should be maintained on cross conveyor chain during operation. To adjust the cross conveyor spring-loaded tightener bolts, move the adjusting nuts on tightener bolts until proper tension on chain is reached. The chain is properly adjusted when the compression spring overall length is 1-1/2". Adjust both sides equally when the cross conveyor extension is down in the working position.

NOTE: Make sure that the cross conveyor extension is in the UNLOAD position when making adjustments.



MAIN APRON ADJUSTMENT

Four main feeder apron adjustment bolts are located at the rear of the forage box. Two are located at the center of the box and are accessible from below the frame. Left-hand tightener bolt is located in panel behind drive shield at left-hand corner of box. Right-hand tightener and bolt is located in panel at right rear corner of the box. All apron chains must be taken up evenly before you use the Forage Box. Check again after the first few loads. The main feeder aprons should be at proper tension at all times. Tighten the full threaded bolts (A) to adjust aprons to approximately .With the 1st apron slat at the rear of the box, the 2nd cross slat inside the box going forward should be able to raise approximately 1" off the floor as shown in the picture at the bottom of the page. When the proper adjustment is reached, replace the hair pin clip in the bolt head. Maintain this tension when operating the box.



Rear Left-Hand
Tightener Bolt



Rear Center Main
Apron Tightener Bolts



Rear Right-Hand
Tightener Bolt

SERVICE

ENTERING FORAGE BOX

If you plan to manually unload the Forage Box utilizing cross conveyor, the following two-man procedure must be followed. NEVER ATTEMPT THIS PROCEDURE ALONE. THE PERSON OUTSIDE OF FORAGE BOX OPERATING CONTROLS MUST NOT LEAVE CONTROLS.

1. Place control lever in beater disengage position.
2. Disengage tractor PTO, shut off tractor, and remove the ignition key.
3. Disengage tractor hydraulics, shut off tractor, and remove the ignition key.
4. Remove variable speed drive belt. This will prevent main aprons from moving.
5. Remove connector link from beater drive roller chain and remove chain from sprockets.
CAUTION: BEATERS ARE NOW FREE TO ROTATE.
6. Using a short piece of chain with hooks, secure top beater to center beater. See picture below.
7. Wrap chain around bar of third beater and top bar of second beater. Secure chain together as tight as possible to eliminate beaters from rotating in either direction. Keep excess chain out of cross conveyor chamber. **NOTE:** Hook chain properly and securely to prevent unhooking during this procedure.
7. Using extreme caution, first person may now climb over beaters.
8. When first person is clear of beaters, second person may start tractor and engage PTO to operate cross conveyor.
9. Before first person attempts to leave forage box, second person must disengage tractor PTO, shut off tractor, and remove the ignition key.
10. When forage box is clear of people, remove safety chain from beaters, reinstall drive belt and beater drive chain. Adjust tightener on roller chain.



SERVICE

ENTERING FORAGE BOX

Rear Unload

When the Forage Box is empty, entry can be made through the rear door. Use the following steps when entering the Forage Box through the rear door.

1. Shut off tractor and remove ignition key.
2. Disconnect hydraulic hoses from tractor.
3. Securely block the rear door open to prevent accidental closure or entrapment.
4. Use a small ladder or similar climbing device to enter the rear of Forage Box.

When the Forage Box is not empty and entry must be obtained, follow the Front Unload Entry Procedure.

CROSS CONVEYOR CLEAN-OUT PAN

1. Shut off tractor and remove ignition key.
2. Remove the (3) wing nuts.
3. Pull the pan out.
4. Remove any material in the conveyor area.
5. Reinstall the (3) wing nuts.



OPTIONS

4th BEATER

A 4th Beater Option is available.

STANDARD PTO

A Standard length PTO Option in lieu of the Hydraulic Drive is available.

LONG PTO

A Long PTO Option in lieu of the Hydraulic Drive is available for customers with quick hitches.

HYDRAULIC CYLINDER KIT FOR 2' EXTENSION

A Hydraulic Cylinder Kit is available for the standard 2' extension.

ELECTRIC CAB CONTROLS

An Electric Cab Control Option is available to control the main apron instead of a manual lever.

LUBRICATION

GENERAL INFORMATION

IMPORTANT: *Catch and dispose of fluid per local waste disposal regulations whenever service is performed on hydraulic components, valves, cylinders, hoses, etc.*

GREASING

There are numerous grease fittings on the Forage Box. Become familiar with all lubrication points and establish a routine to ensure complete lubrication of the Forage Box. Lubricating properly and often (every 10 hours) with a high-quality grease will prolong the life of the forage box. Replace any missing or plugged grease fittings. Wipe dirt from the fittings before greasing to prevent the dirt from being forced into the bearing or pivot. Grease should come out around the shaft on sleeve type bearings. On the sealed ball bearings, grease should be added slowly until a slight bead forms at the seal, indicating the correct amount of lubricant. To minimize dirt build-up, avoid excessive greasing. After greasing, wipe off the excess grease from around the outside of the bearings to prevent the accumulation of chaff and grit.

GEARBOXES

Main Apron Drive Gearbox: Keep the main apron gearbox filled to the oil level plug in cover of gearbox using 85W140 lubricant.

Beater Drive Gearbox: Keep the beater drive gearbox filled to the center of the shafts. Use 80W90 lubricant.

DRIVE CHAINS

Lubricate the drive chains with a light machine oil. Keep chains aligned with sprockets; this lengthens the life of the sprockets and chain. Lubricate chains often.

PTO ASSEMBLY

Keep the male and female shafts of the PTO well-lubricated and free-sliding. Failure to observe this precaution will result in excessive pressure being required to collapse or extend the assembly while subject to operating torque. This excessive force may damage the main shaft bearings. Never lubricate the shield surfaces. The shield surfaces must be kept dry, as dirt accumulation on them will cause the shields to bind and not rotate. Dented or damaged PTO shields will also result in excessive force being applied against the jackshaft. Damaged shields also cause difficulty when installing the assembly. If at any time the shields do not turn freely, they should be checked to determine the cause and repaired or cleaned. To avoid damage to the main drive bearings, avoid turning sharp corners while PTO is running. Start and stop PTO slowly to avoid damage to the drive line.

LUBRICATION

(1) on idler sprocket.

(1) on beater drive clutch

Remote Zerk bank for fittings on beaters & apron drive shaft.

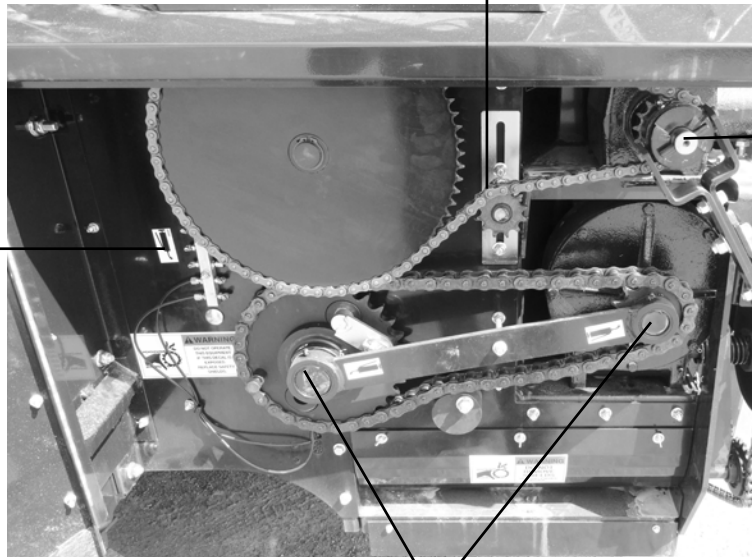

(1) on each end of brace

One on each side of the variable drive outer upper sheave.

(1) on variable drive inner lower sheave

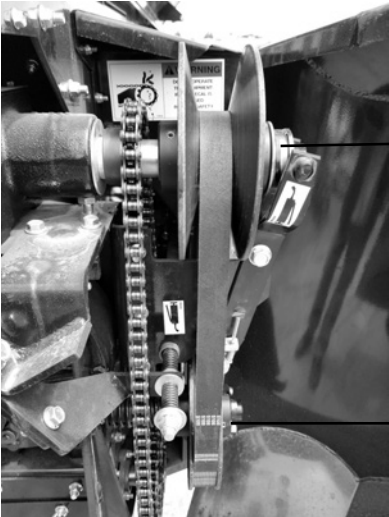

(1) on Clutch Idler Pivot Shaft (Under Shield)

(1) on Clutch Control Handle (Under Shield)



LUBRICATION

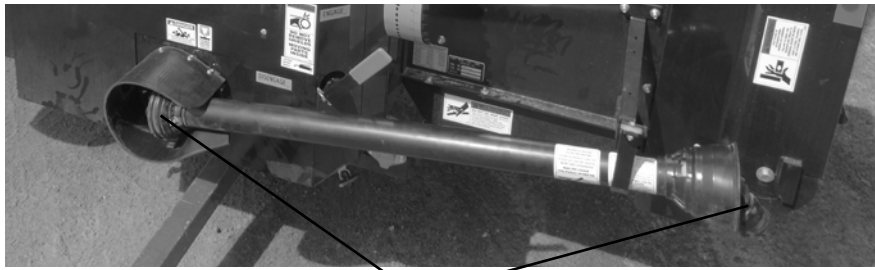

(2) One each end of the PTO at U-joint if equipped with the PTO option.



Remote Zerk bank for lines to the beaters & apron drive shaft.

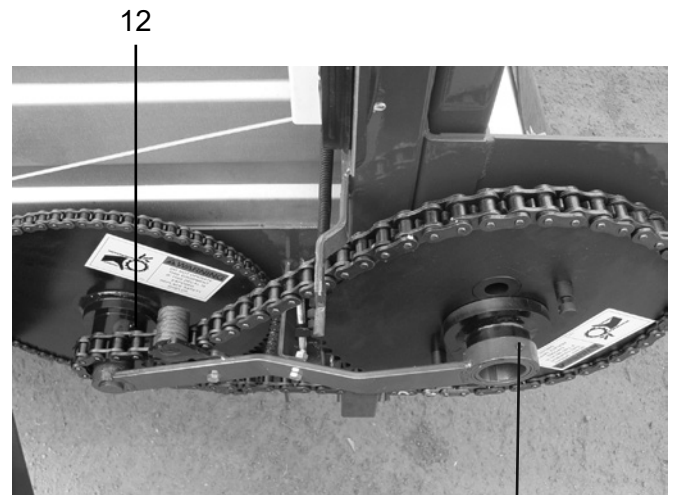

- (4) One on each **MAIN** apron shaft rear sprocket
- (4) One on each sprocket of the **LOWER** idler shaft
- (4) One on each sprocket of the **UPPER** idler shaft
- (2) on each of the rear door lock handles

DECAL LOCATION

Your H&S Forage Box was manufactured with operator safety in mind. Located on the Forage Box are various decals to aid in operation and to warn of danger or caution areas. Pay close attention to all the decals on your Forage Box.



**DO NOT REMOVE ANY OF THESE DECALS. IF DECALS ARE LOST, DAMAGED, OR IF YOUR SUPER DUTY IS REPAINTED, REPLACE DECALS.
REMEMBER: DECALS ARE FOR YOUR PROTECTION AND SAFETY.**

Listed below are the decals on your Forage Box. These decals may be ordered individually by part number.

<u>Part #</u>	<u>Quantity</u>	<u>Description</u>
311	1	Patent Decal
1494A	5	Do not operate this machine if this decal is exposed. Replace safety shields.
1494B	2	Do not remove shields - moving parts inside.
1494C	7	Stay Clear - Moving parts under this area.
1494F	1	Never enter forage box unless the safety chain precautions are followed.
1494H	3	Stay Clear of beater and/or cross conveyor if power source or PTO is running
1494I	2	Keep Out
1494J	1	Do not clean or work on the machine without first disengaging power
1494K	3	Do not remove shields - moving parts inside.
1494O	3	Emergency stop cable functions when box is being operated as a Front Unload
1494P	1	Maintain safe clearance from electrical power lines.
1494Q	1	When operating forage box as a rear unload, operator should remain in tractor
2495	1	Keep Children Away
5696D	1	Disengage
5696E	1	Engage
5896B	1	Rotating driveline.
5896C	1	To prevent serious injury or death never operate unless emergency stop functions
8509	1	RH Yellow Strip
8510	1	LH Yellow Strip
11599	1	Do not go near leaks
12502A	1	Stay Clear of Extension When Raising or Lowering
31300	2	Insert Pin Until Flush
54033	1	3" Made in USA
56713	1	Help avoid injury - Read and understand the operators manual
56842	1	Entering Forage Box
66076	8	Grease Zerks Behind Shield
77939	1	Stand Clear: Door May Open or Close Quickly
80249	1	H&S HD7+4 Decal Front
80250	2	HD7+4 Side Decal
80252	3	H Metal Sign
80253	3	& Metal Sign
80254	3	S Metal Signs
84044	1	FEMA Decal
84045	1	H&S Since 1967
87665	2	Model Number Decal 17'
87666	2	Model Number Decal 19'
87667	2	Model Number Decal 21'
92706	2	Stay Clear of Extension when Raising or Lowering
093020	23	Grease zerk decal
093366	1	Operators Manual
1033185	1	Emergency Stop
1043185	1	Emergency Stop
1202177	2	Push to Stop

DECAL LOCATION

<u>Part #</u>	<u>Quantity</u>	<u>Description</u>
1191	1	Speed Control Decal
742191	1	Clean Out Instructions
DCAMB	7	Amber Reflective Decal
DCRED	3	Red Reflective Decal

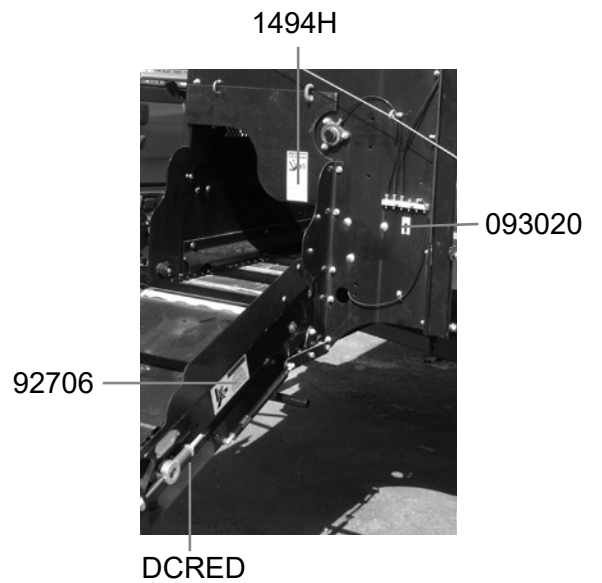
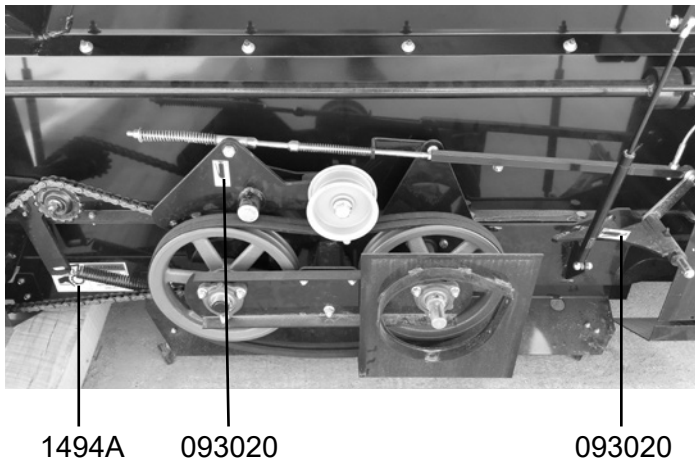
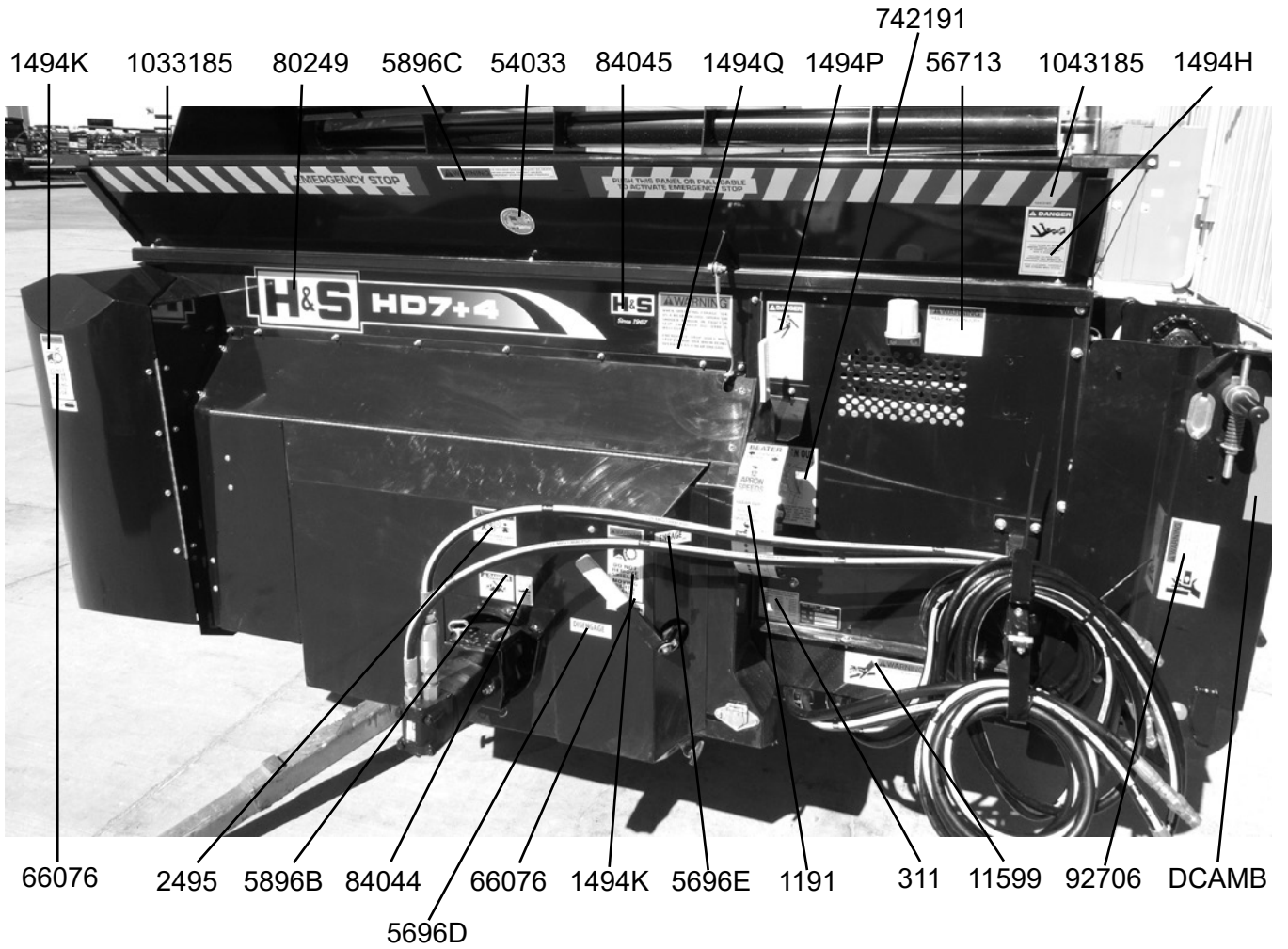

DECAL LOCATION

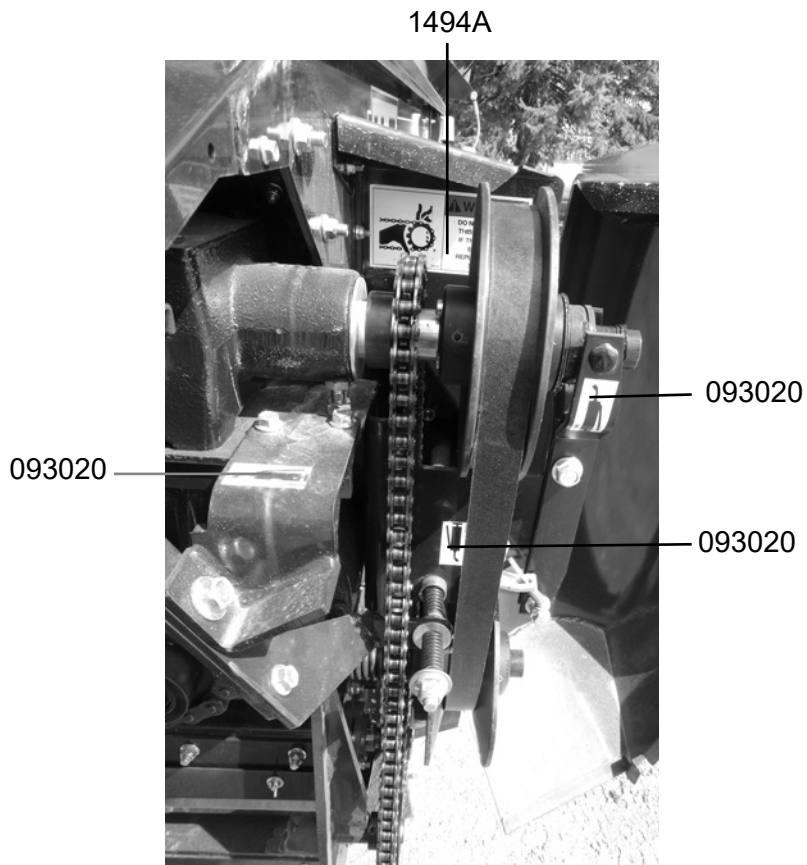
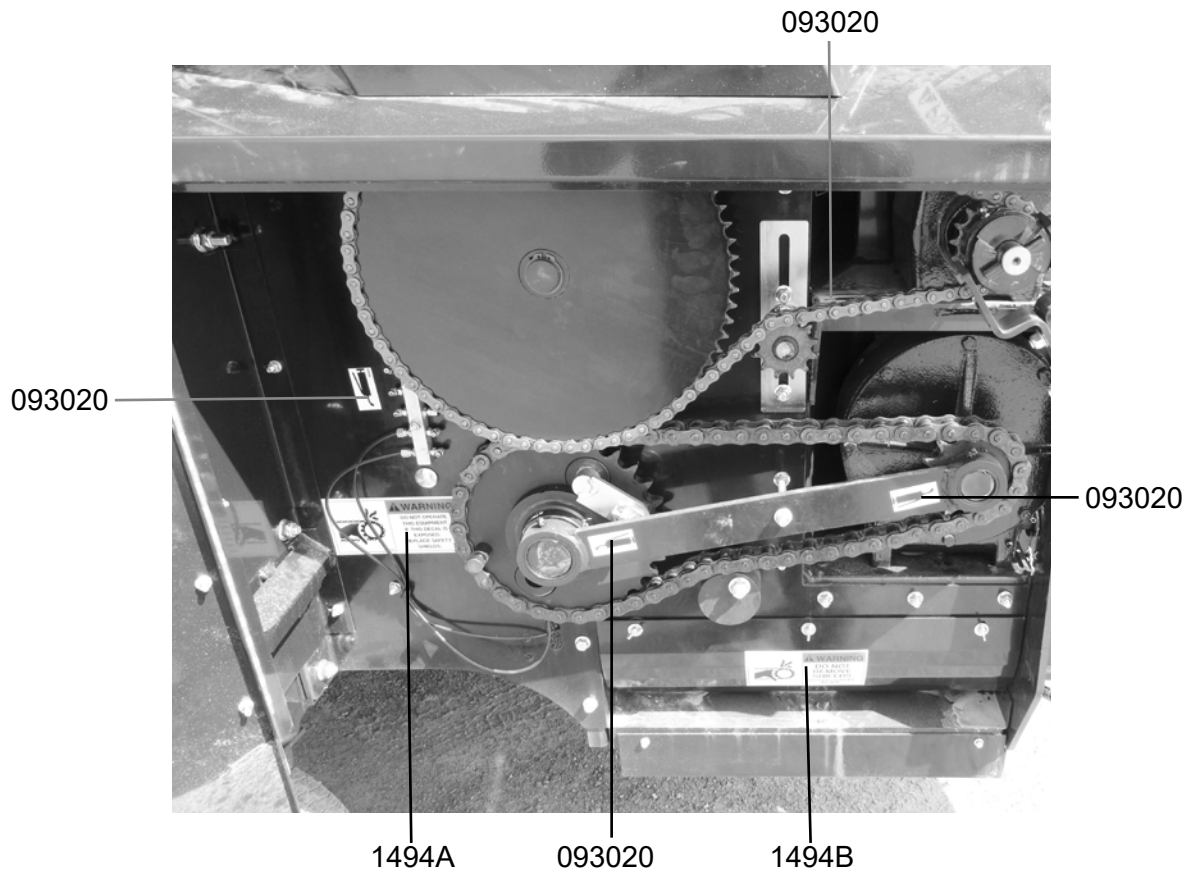

DECAL LOCATION

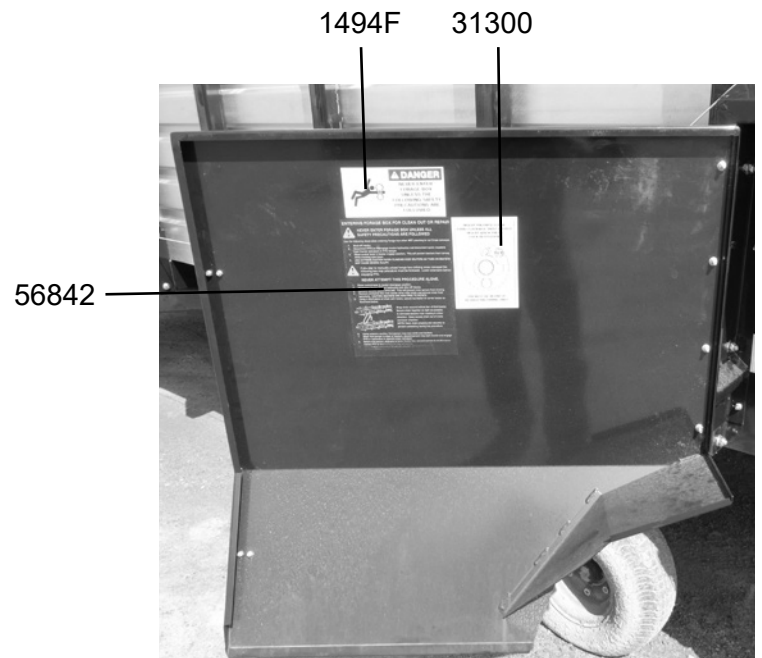
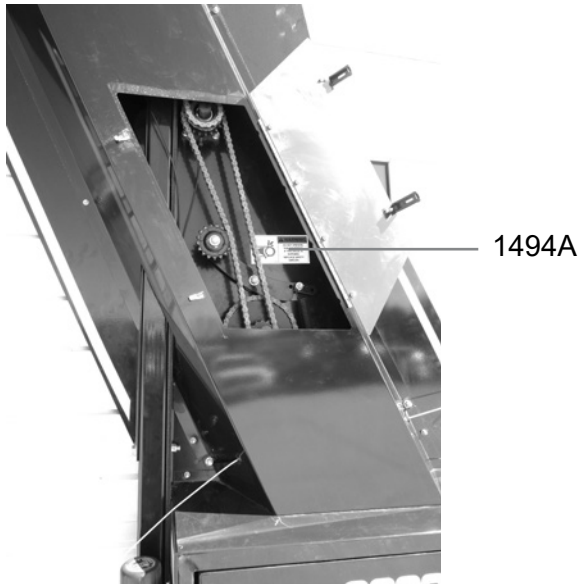
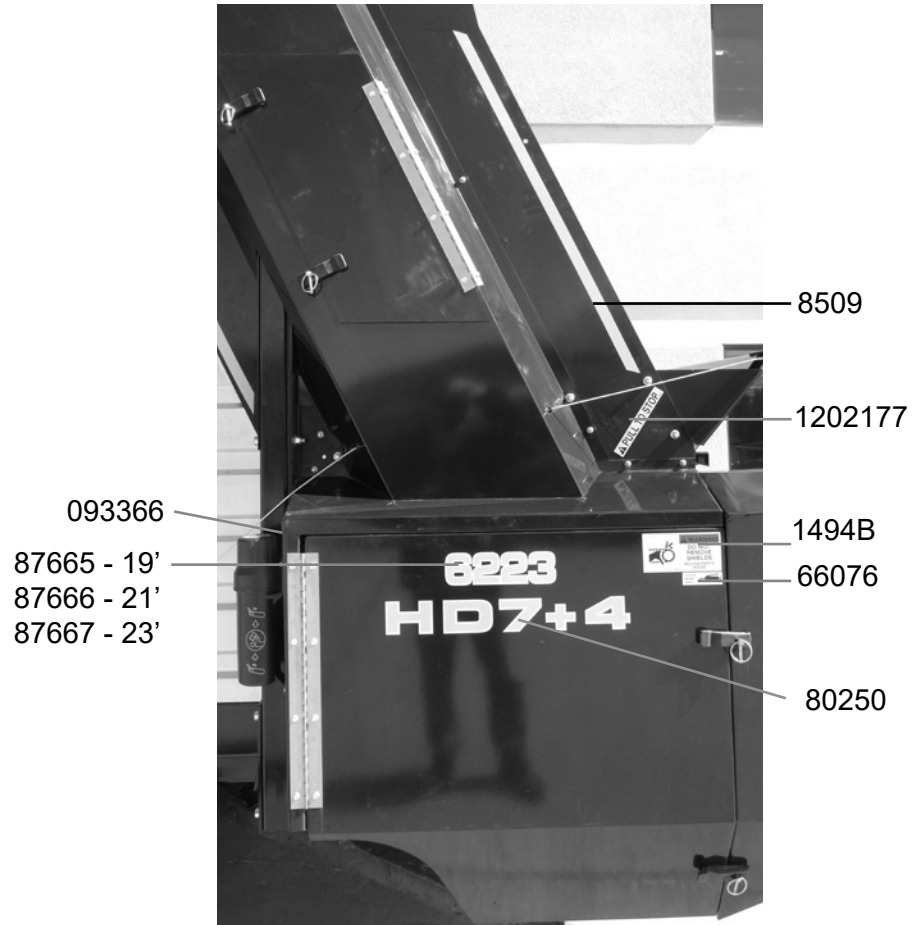

DECAL LOCATION

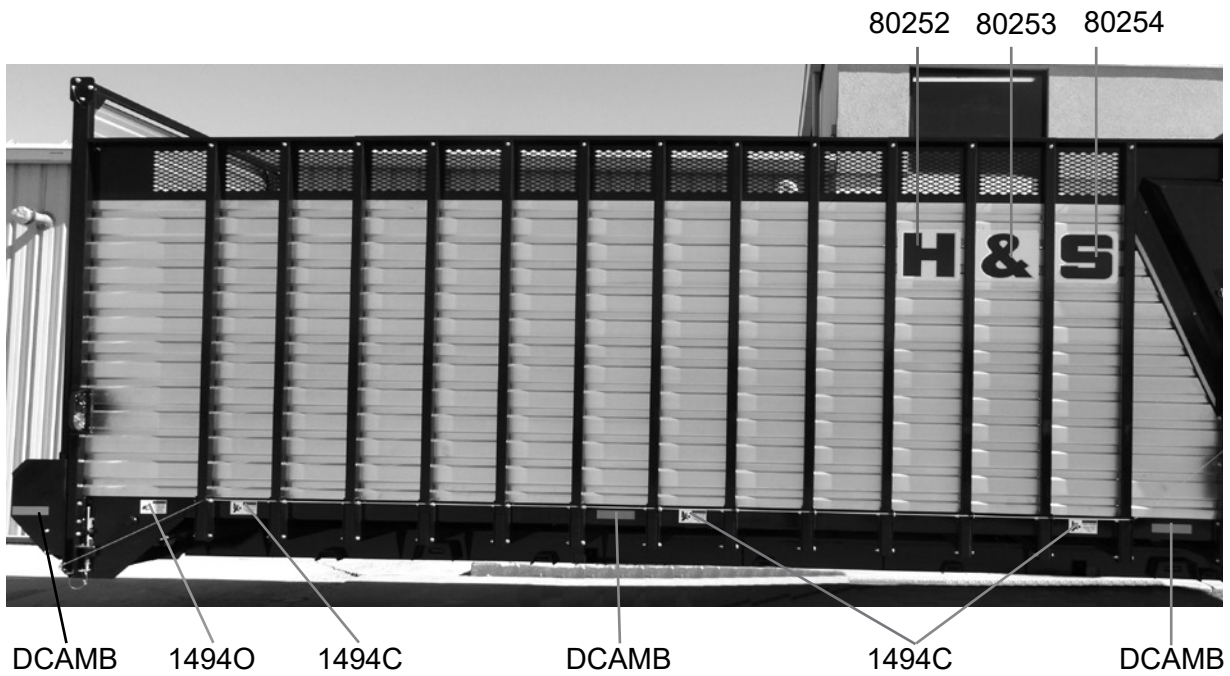

DECAL LOCATION

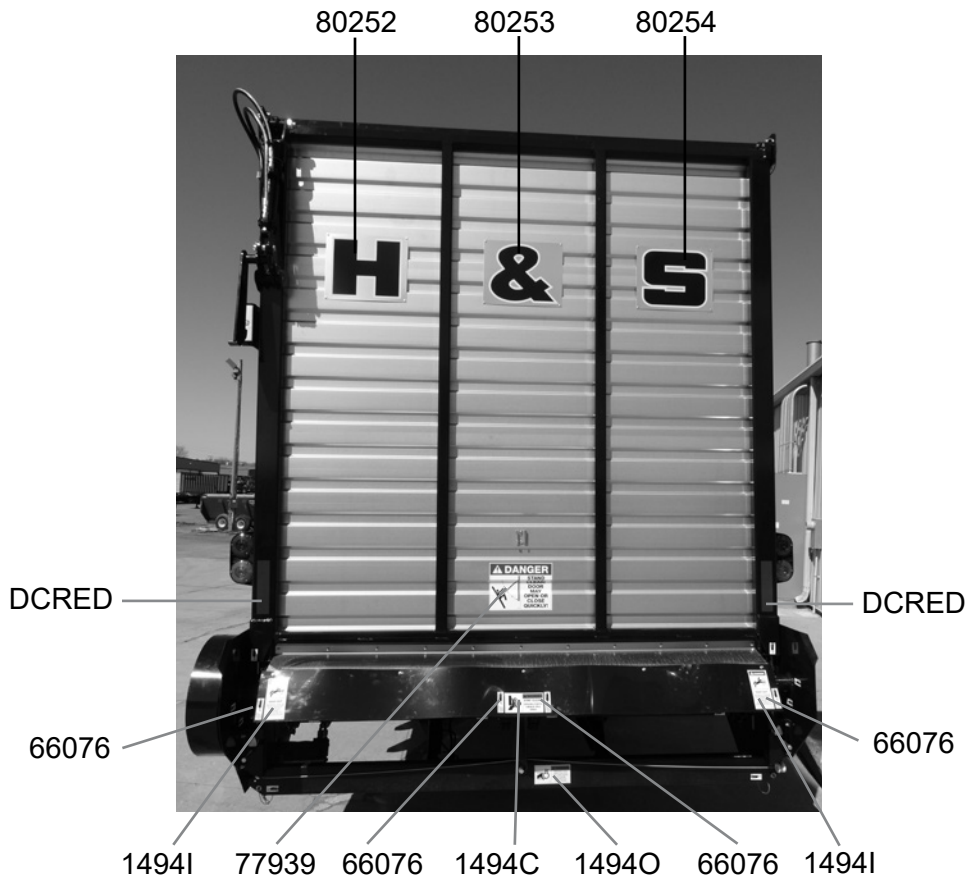

- 093020
- (4) One on each main apron rear idler sprocket
 - (4) One on each main apron rear sprocket
 - (2) on each of the rear door lock handles

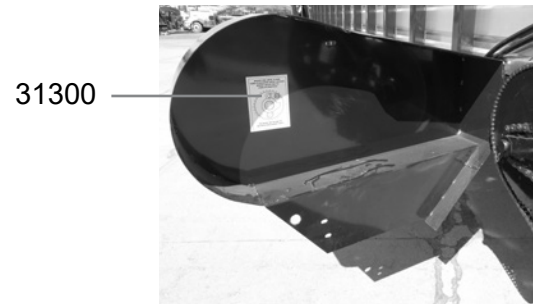
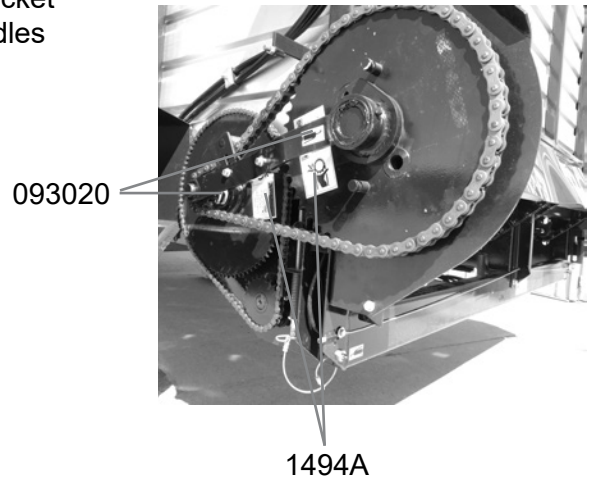
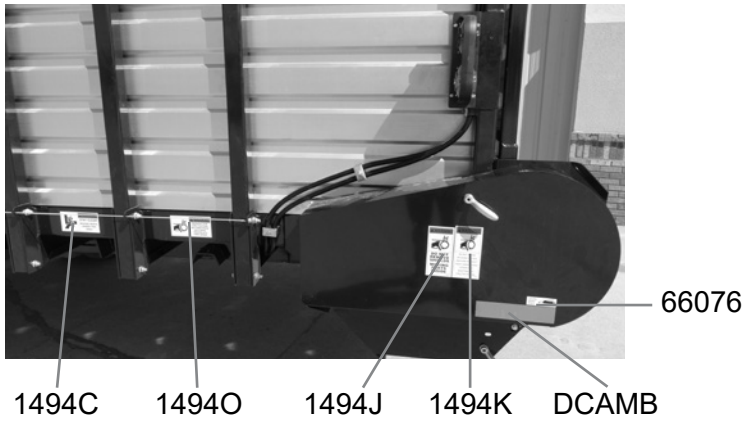

H&S MFG. CO.

products approved

for the

FEMA

SEAL OF QUALITY



Manufactured by:

H&S MANUFACTURING CO., INC.

2608 S. HUME AVE. MARSHFIELD, WI 54449

(715) 387-3414 | hsmfgco.com

