



# OPERATOR'S MANUAL

FB745219  
FORAGE BOX

Part #HS101730  
Rev. #00  
HSMFG0324

Starting Ser. #422C519001

# CONTENTS

Warranty . . . . .	1
Manufacturer's Statement. . . . .	2
Warranty Registration Form . . . . .	3
Dealer Pre-Delivery Checklist. . . . .	5
Dealer Delivery Checklist. . . . .	7
Safety Information - Be Alert Symbol. . . . .	9
Safety Information - Explanation of Safety Signs. . . . .	8
Safety Information - Danger Warning Signs. . . . .	11-12
Safety Information - Warning - Owner Must Read and Understand. . . . .	13
Safety Information - Warning Emergency Stop. . . . .	14
Cap Screw Torque Values. . . . .	15
Hydraulic Fitting Torque Specifications . . . . .	16-17
Set-Up & Assembly. . . . .	18
Transporting. . . . .	19
Preparing for Operation. . . . .	20
Operation. . . . .	21-22
Adjustments. . . . .	23-25
Service. . . . .	27
Optional Features & Accessories. . . . .	28
Lubrication Guide. . . . .	29-31
Decal Location & Identification. . . . .	32-37
Service Notes. . . . .	38

## H&S Manufacturing Co., Inc. Warranty

H&S Manufacturing Co., Inc. ("H&S") warrants this product to be free from defect in material and workmanship. Except as noted below, this warranty term is twelve (12) months on parts and labor, and twenty-four (24) months on parts only from the date of delivery of the product to the original purchaser by an authorized H&S dealer. Under this warranty, H&S will repair or replace, at its option, any covered part which is found to be defective in material or workmanship during the applicable warranty term. In no case will the covered repair cost of a part or parts exceed the replacement cost of that part. In no case, unless pre-authorized by H&S, will a component be replaced versus repaired unless the cost of labor and parts exceeds 75% of the cost of a new component. Warranty repairs must be performed by H&S or a dealer authorized by H&S to sell and/or service the product involved, and will use only new or remanufactured parts or components furnished by H&S. Any warranty repairs needing to be performed by a third party must be pre-authorized by H&S. Standard freight costs will be covered by H&S for any part used to make a warrantable repair, any form of express freight will not be covered unless pre-authorized by H&S. This warranty includes approved parts and labor to repair the product but does not include, and the purchaser is responsible for, any service call and/or transportation of the product to and from the dealer's place of business, for any costs related to travel, for any premium charged for overtime labor requested by the purchaser, and for any service work not directly related to any defect covered under this warranty. This warranty includes only those components of the product manufactured by H&S. Warranty for any component not manufactured by H&S including, but not limited to, engines, batteries, tires, rims, hydraulic motors, pumps, etc. are covered by the warranty, if any, provided separately by their respective manufacturers. H&S reserves the right to request the return of any failed component.

This warranty in all its parts is extended solely to the original purchaser of the product, is terminated upon any subsequent transfer or sale from or by the original purchaser, and extends no third party benefits or rights whatsoever. The warranty term for any product used in any for hire, rental fleet or rental application, is limited to six (6) months from the date of delivery of the product to the original purchaser by an authorized H&S dealer.

This warranty does not include: (1) Any product that has been altered or modified in ways not approved by H&S; (2) Depreciation or damage caused by normal wear, use for which the product was not designed, misuse, improper or insufficient maintenance, improper operation, accident or failure to follow the product Operator's Manual recommendations and product decal recommendations; (3) Normal maintenance parts and service; (4) Repairs made with parts other than those available from H&S or performed by anyone other than H&S or a dealer authorized by H&S to sell and/or service the product involved.

To secure warranty service the purchaser must report the product defect to a dealer authorized by H&S to sell and/or service the product involved within the applicable warranty term together with evidence of the warranty start date and make the product available to that dealer within a reasonable period of time.

For these warranty terms to be in effect the selling authorized H&S dealer and/or the customer must submit the warranty registration to H&S.

THERE ARE NO WARRANTIES WHICH EXTEND BEYOND THE DESCRIPTION ON THE FACE OF THIS WARRANTY. H&S and the companies affiliated with it make no warranties, representations, or promises, express or implied, as to the performance or freedom from defect of its products other than those set forth above and NO IMPLIED WARRANTY OF MERCHANTABILITY, FITNESS OR FITNESS FOR A PARTICULAR PURPOSE IS MADE. IN NO EVENT WILL THE DEALER, H&S OR ANY COMPANY AFFILIATED WITH H&S BE LIABLE FOR INCIDENTAL OR CONSEQUENTIAL DAMAGES. The ONLY REMEDY the purchaser has in connection with the breach of performance of any warranty on H&S products are those set forth above.

The selling dealer has no authority to make any representation or promise on behalf of H&S, or to modify the terms or limitations of this warranty in any way.

## **MANUFACTURER'S STATEMENT**

Your New H&S Product has been manufactured of the finest quality materials and components. The performance you get from your machine is largely dependent upon how well you read and understand this manual and apply this knowledge. There is a right and a wrong way to do everything. Please do not assume that you know how to operate and maintain your Machine before reading this manual carefully. Keep this manual available for ready reference.

# WARRANTY REGISTRATION

- ❖ Date of Purchase: \_\_\_\_\_
  - ❖ Purchaser Name: \_\_\_\_\_
  - ❖ Street Address: \_\_\_\_\_
  - ❖ City: \_\_\_\_\_
  - ❖ State: \_\_\_\_\_ Zip: \_\_\_\_\_
  - ❖ Phone Number: \_\_\_\_\_
  - ❖ E-mail Address: \_\_\_\_\_
  - ❖ Product: \_\_\_\_\_
  - ❖ Model Number: \_\_\_\_\_
  - ❖ Serial Number: \_\_\_\_\_
  - ❖ You have received the Operators Manual for this product. Yes \_\_\_\_\_ No \_\_\_\_\_
  - ❖ Interested in receiving the H&S Newsletter? Yes \_\_\_\_\_ No \_\_\_\_\_
- 

- ❖ Dealer Name: \_\_\_\_\_
- ❖ Street Address: \_\_\_\_\_
- ❖ City: \_\_\_\_\_
- ❖ State: \_\_\_\_\_ Zip: \_\_\_\_\_
- ❖ Signature: \_\_\_\_\_

❖ *All fields must be filled out to insure prompt notification of product and/or warranty updates.*

Please mail the completed WARRANTY REGISTRATION FORM to:  
H&S Manufacturing Co., Inc.  
2608 S. Hume Ave.  
Marshfield, WI 54449

(Remove Copy At Perforation)

**Intentionally Left Blank**

# H&S DEALER PRE-DELIVERY CHECKLIST

## **AFTER COMPLETION, DEALER SHOULD REMOVE AND RETAIN FOR RECORDS**

After the Forage Box has been completely set up, check to be certain it is in correct operating order before delivering to the customer. The following is a list of points to inspect. Check off each item as you have made the proper adjustments and found the item operating satisfactorily.

- Forage Box was not damaged in shipment. Check for dents and loose or missing parts. Report damage immediately to H&S Manufacturing Co., Inc.
- Forage Box has been correctly assembled according to instructions in this manual.
- All bolts and fasteners are tight.
- All shields and guards are in place and secured.
- All grease fittings have been lubricated. Gearboxes are filled to proper levels. See Lubrication Chapter of this manual for details.
- Hoses and fittings if applicable, are properly attached and there are no visible leaks.
- All drive chains are adjusted to proper tension. See Adjustment Chapter of this manual.
- Decals are in place and legible.
- Connect the Forage Box to a tractor and attach the PTO and make sure that the PTO guards turns freely.
- Connect the lights to the tractor. Lights and wiring functioning properly.
- Run the Forage Box and make sure all components operate properly.
- Any hydraulics, if applicable, do not leak under pressure.

Model Number \_\_\_\_\_

Serial Number \_\_\_\_\_

Dealer's Name \_\_\_\_\_

Inspection Date \_\_\_\_\_

Signature of Pre-Delivery Inspector \_\_\_\_\_

(Remove Dealer File Copy At Perforation)

**Intentionally Left Blank**



# **H&S DEALER DELIVERY CHECKLIST**

## **AFTER COMPLETION, DEALER SHOULD REMOVE AND RETAIN FOR RECORDS**

This checklist that follows is an important reminder of valuable information that should be passed on to the customer at the time this Forage Box is delivered.

Check off each item as you explain it to the customer.

This delivery checklist, when properly filled out and signed, assures the customer that the pre-delivery service was satisfactorily performed.

- Explain to the customer that the pre-delivery inspection was made.
- Explain to the customer all the safety precautions they must exercise when operating this unit.
- Explain recommended loads for different types of materials.
- Explain to customer that regular lubrication is required for proper operation and long life of machine.
- Show customer the lubrication section of Owner's Manual.
- Give the customer Owner's Manual and make sure they read and understand all operating and service instructions.
- Have customer sign a completed "Warranty Registration," and mail it promptly.

Date Delivered \_\_\_\_\_

Dealer's Name \_\_\_\_\_

By \_\_\_\_\_

Signature of Original Buyer \_\_\_\_\_

Note: Warranty is not valid until warranty card is completed and returned to H&S Mfg. Co., Inc.

**Intentionally Left Blank**

**SAFETY INFORMATION**



**BE  
ALERT!**

**YOUR SAFETY  
IS INVOLVED.**

**THIS SYMBOL IS USED THROUGHOUT THIS BOOK WHENEVER YOUR PERSONAL SAFETY IS INVOLVED. TAKE TIME TO BE CAREFUL. REMEMBER: THE CAREFUL OPERATOR IS THE BEST OPERATOR. MOST ACCIDENTS ARE CAUSED BY HUMAN ERROR. CERTAIN PRECAUTIONS MUST BE OBSERVED TO PREVENT THE POSSIBILITY OF INJURY OR DAMAGE.**

**H&S MANUFACTURING CO., INC.**

# **SAFETY INFORMATION**

Keep signs in good condition. Immediately replace any missing or damaged signs.

## **RECOGNIZE SAFETY INFORMATION**

This is the safety alert symbol. When you see this symbol on your machine or in this manual, be alert to the potential for personal injury. Follow recommended precautions and safe operating practices.



### **UNDERSTAND SIGNAL WORDS**

A signal word - DANGER, WARNING, or CAUTION - is used with the safety alert symbol. DANGER identifies the most serious hazards.

Safety signs with signal word DANGER or WARNING are typically near specific hazards.

General precautions are listed on CAUTION safety signs.



### **FOLLOW SAFETY INSTRUCTIONS**

Carefully read all safety messages in this manual, and all safety signs on your machine. Follow all recommended precautions and safe operating procedures.

### **OBSERVE MAXIMUM TRANSPORT SPEED**

**The maximum transport speed for this implement is 32 km/h (20 mph).**

Some tractors are capable of operating at speeds that exceed the maximum transport speed of this implement. Regardless of the maximum speed capability of the tractor being used to tow this implement, do not exceed the implement's maximum transport speed.

Exceeding the implement's maximum transport speed can result in:

- \* Loss of control of the tractor/implement combination
- \* Reduced or no ability to stop during braking
- \* Implement tire failure
- \* Damage to the implement structure or its components

Use additional caution and reduce speed when towing under adverse surface conditions, when turning, and when on inclines.

Do not attempt transport if the fully loaded implement weighs more than 1.5 times the weight of the tractor.



# SAFETY INFORMATION

**WARNING**

**HELP AVOID INJURY**

- READ & UNDERSTAND THE OPERATOR'S MANUAL PROVIDED WITH THIS MACHINE. IF MISPLACED CALL H & S MANUFACTURING AT 715-387-3414 WITH MODEL AND SERIAL NUMBER.
- UNDERSTAND ALL SAFETY WARNINGS AND FUNCTION OF CONTROLS.
- KEEP SAFETY DEVICES IN PLACE AND WORKING.
- KEEP YOURSELF AND OTHERS WELL CLEAR OF MOVING PARTS.
- DISCONNECT ALL POWER BEFORE SERVICING OR CLEANING THIS MACHINE.
- NEVER ENTER FORAGE BOX FOR CLEAN OUT OR REPAIR WITHOUT FOLLOWING THE STEPS OUTLINED IN THE OPERATOR'S MANUAL AND INSIDE THE MAIN SIDE SHIELD.
- DO NOT EXCEED 30 MPH

92412

**WARNING**

**WHEN OPERATING FORAGE BOX AS A REAR UNLOAD, OPERATOR SHOULD REMAIN IN TRACTOR SEAT AND KEEP ALL OTHERS WELL CLEAR.**

**EMERGENCY STOP DOES NOT STOP FORAGE BOX WHEN BEING OPERATED AS A REAR UNLOAD.**

1494G



**WARNING**

**DO NOT GO NEAR LEAKS**

- High pressure oil easily punctures skin causing serious injury, gangrene or death.
- If injured, seek emergency medical help. Immediate surgery is required to remove oil.
- Do not use finger or skin to check for leaks.
- Lower load or relieve hydraulic pressure before loosening fittings.

11559

**WARNING**



**KEEP CHILDREN AWAY AT ALL TIMES!**

2495

**DANGER**



5896B

**ROTATING DRIVELINE CONTACT CAN CAUSE DEATH**

**DANGER**



**ROTATING DRIVELINE CONTACT CAN CAUSE DEATH KEEP AWAY!**

DO NOT OPERATE WITHOUT:

- ALL DRIVELINE, TRACTOR AND EQUIPMENT SHIELDS IN PLACE.
- DRIVELINES SECURELY ATTACHED AT BOTH ENDS.
- DRIVELINE SHIELDS THAT TURN FREELY ON DRIVELINE.

1494L



**WARNING**

**STAY CLEAR OF EXTENSION WHEN RAISING OR LOWERING. FAILURE TO HEED THIS WARNING MAY RESULT IN PERSONAL INJURY OR DEATH. KEEP CLOTHING, YOURSELF AND OTHERS WELL CLEAR.**

92706

**WARNING**



**DO NOT REMOVE SHIELDS MOVING PARTS INSIDE**

1494K

**WARNING**



**DO NOT CLEAN OR WORK ON THIS MACHINE WITHOUT FIRST DISENGAGING POWER AND SHUTTING OFF TRACTOR ENGINE.**

1494J

**DANGER**



**MAXIMUM OPERATING SPEED 540 RPM**

**OVERSPEED CAN CAUSE SEVERE INJURY OR DEATH DO NOT OPERATE WITH:**

- 1000 RPM TRACTOR PTO
- TRACTOR PTO ADAPTER

**DANGER**



**MAINTAIN SAFE CLEARANCE FROM ELECTRICAL POWER LINES AND AVOID CONTACT WITH ANY ELECTRICALLY CHARGED CONDUCTOR.**

**CONTACT WITH ELECTRIC POWER SOURCES CAN RESULT IN ELECTRICAL SHOCK OR ELECTROCUTION.**

**FAILURE TO HEED THIS WARNING MAY RESULT IN SERIOUS INJURY OR DEATH.**

1494P

**WARNING**

**TO PREVENT SERIOUS INJURY OR DEATH NEVER OPERATE THIS UNIT UNLESS EMERGENCY STOP FUNCTIONS PROPERLY**

5896C

# SAFETY INFORMATION

	<b>⚠ WARNING</b>
	<p><b>DO NOT OPERATE THIS EQUIPMENT IF THIS DECAL IS EXPOSED. REPLACE SAFETY SHIELDS.</b></p> <p style="font-size: small;">1494A</p>

	<b>⚠ DANGER</b>
	<p><b>NEVER ENTER FORAGE BOX UNLESS THE FOLLOWING SAFETY PRECAUTIONS ARE FOLLOWED.</b></p> <p style="font-size: small;">1494F</p>

<b>⚠ DANGER</b>

<b>KEEP OUT</b>
<p><b>DISENGAGE ALL POWER AND SHUT OFF TRACTOR ENGINE BEFORE ATTEMPTING TO ENTER OR CLEAN FORAGE BOX. FAILURE TO HEED THIS WARNING MAY RESULT IN PERSONAL INJURY OR DEATH</b></p> <p style="font-size: small;">1494I</p>

<b>⚠ DANGER</b>

<p><b>STAY CLEAR OF BEATER AND/OR CROSS CONVEYOR IF POWER SOURCE OR PTO IS RUNNING</b></p> <p><b>FAILURE TO HEED THIS WARNING MAY RESULT IN PERSONAL INJURY OR DEATH</b></p> <p><b>KEEP CLOTHING, YOURSELF AND OTHERS WELL CLEAR.</b></p> <p style="font-size: small;">1494H</p>

	<b>⚠ WARNING</b>
	<p><b>STAY CLEAR MOVING PARTS UNDER THIS AREA</b></p> <p style="font-size: small;">1494C</p>

	<b>⚠ DANGER</b>
	<p><b>STAY CLEAR OF EXTENSION WHEN RAISING OR LOWERING</b></p> <p style="font-size: small;">12502A</p>

	<b>⚠ WARNING</b>
	<p><b>EMERGENCY STOP CABLE FUNCTIONS ONLY WHEN FORAGE BOX IS BEING OPERATED AS A FRONT UNLOAD</b></p> <p style="font-size: small;">1494D</p>

	<b>⚠ WARNING</b>
	<p><b>DO NOT REMOVE SHIELDS MOVING PARTS INSIDE</b></p> <p style="font-size: small;">1494B</p>

## TRACTORS:

This Operator's Manual uses the term "Tractor" when identifying the power source.



### **TO PREVENT SERIOUS INJURY OR DEATH, NEVER OPERATE THIS UNIT UNLESS EMERGENCY STOP FUNCTIONS PROPERLY.**

BEFORE YOU ATTEMPT TO OPERATE THIS EQUIPMENT, READ AND STUDY THE FOLLOWING INFORMATION. IN ADDITION, MAKE SURE THAT EVERY INDIVIDUAL WHO OPERATES OR WORKS WITH THIS EQUIPMENT, WHETHER FAMILY MEMBER OR EMPLOYEE, IS FAMILIAR WITH THESE SAFETY PRECAUTIONS. KNOW HOW TO STOP MACHINE BEFORE STARTING IT.

If the machine becomes clogged or for servicing, Stop the tractor engine, remove ignition key and allow all mechanisms to stop. Before cleaning or working on the machine, detach the PTO shaft, and completely disengage the tractor hydraulics.

**DO NOT** attempt to perform maintenance or repair with tractor running, PTO and hydraulic hoses connected to the tractor.

**DO NOT ALLOW PERSONNEL OTHER THAN THE QUALIFIED OPERATOR NEAR THE FORAGE BOX.**

Be sure the Forage Box is clear of people, tools, and other objects before engaging PTO.

**DO NOT** allow minors to operate or be near the Forage Box.

Do not step over PTO shaft: Stay clear of PTO at all times.

**DO NOT** step up on the Forage Box at any time while in operation.

**BEFORE** starting tractor, be sure PTO shields turn freely and PTO is securely locked to tractor.

**NEVER** start the Forage Box until all guards and safety shields are secured in place.

**STAY CLEAR** of discharge conveyor opening when in operation.

Keep hands, feet, and clothing away from all moving parts when the Forage Box is in operation.

Loose or floppy clothing should not be worn by the operator.

Never operate the Forage Box with a PTO speed greater than the recommended PTO RPM.

**STAY CLEAR** of hydraulic lines, they may be under extreme pressure or heat.

**NEVER** manually feed material into the beaters.

**DO NOT** clean, adjust, or lubricate the machine when any part is in operation.

**CHECK** frequently to be assured that the emergency stop mechanism is in proper operating condition.

**CAUTION** - Beware of low electrical wires.

**NEVER** hook up 1000 RPM tractor to the Forage Box.

**STAY CLEAR** of rear of Forage Box at all times.

H&S Mfg. Co. always takes the operator and their safety into consideration and guards exposed moving parts for their protection. However, some areas cannot be guarded or shielded in order to assure proper operation. In addition, the Operator's Manual and decals on the Forage Box itself warn you of further danger and should be read and observed closely.

**Study The Above Safety Rules**  
**ATTENTION - BE ALERT - YOUR SAFETY IS INVOLVED**

## SAFETY INFORMATION



# WARNING

**TO PREVENT SERIOUS INJURY OR DEATH, NEVER OPERATE THIS UNIT UNLESS EMERGENCY STOP FUNCTIONS PROPERLY**

## **EMERGENCY STOP**

1. In case of an emergency, pulling the trip cables, pushing the stop panel rearward, or disengaging the lever will stop cross conveyor, beaters, and main apron.
2. Activating the emergency stop only stops box functions. The PTO shaft will continue to rotate.
3. Keep excessive slack out of trip cables.
4. Trip emergency stop occasionally, and when starting the unit after periods of storage, to ensure proper function.
5. To reset, move the lever clockwise to engage position.

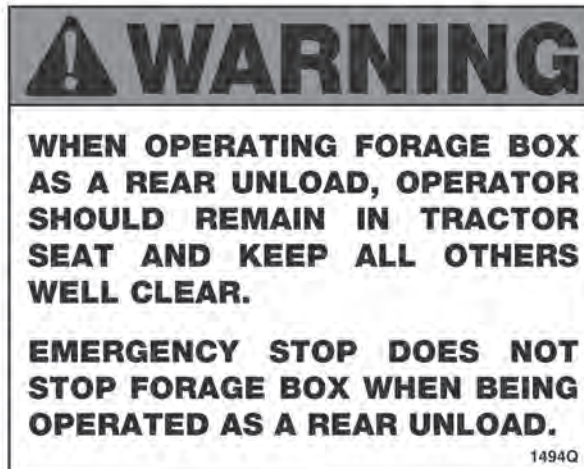



# CAP SCREW TORQUE VALUES

The specifications below are the torque values for fasteners as it adheres to the SAE torque value standards. All fasteners should be torqued to the proper values found in the figures below unless otherwise specified by the engineering drawing.

Lubed torque would be any fastener that has grease, liquid Loctite, oil, etc. on the threads.

Dry torque would be any fastener which has threads that are clean and dry and do not have any liquid Loctite or grease on them.

## Hex Head Fasteners

The figure shown below shows how to determine what grade a fastener is.

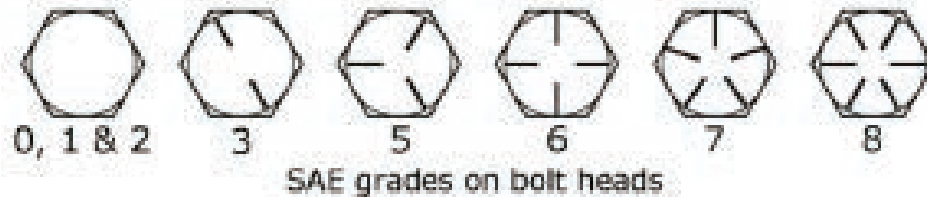

Diam & Thrds Per Inch	SUGGESTED ASSEMBLY TORQUE VALUES						WORKING TORQUE			
	SAE GRADE 2 - 6*		SAE GRADE 5		SAE GRADE 8		18-8 SS	316 SS	BRASS	SILICON BRONZE
	Dry FT. LB.	LUB FT. LB.	Dry FT. LB.	LUB FT. LB.	Dry FT. LB.	LUB FT. LB.	IN LBS	IN LBS	IN LBS	IN LBS
1/4-20	5.5	4.2	8	6.3	12	9	75.2	78.8	61.5	68.6
1/4-28	6.3	4.7	10	7.2	14	10	84.0	99.0	77.0	87.0
5/16-18	11	8	17	13	24	18	132	138	107	123
5/16-24	12	9	19	14	27	20	142	147	118	131
3/8-16	20	15	30	23	45	35	236	247	192	219
3/8-24	23	17	35	25	60	35	258	271	212	240
7/16-14	32	24	50	35	70	50	376	383	317	348
7/16-20	36	27	55	40	80	60	400	418	327	371
1/2-13	50	35	75	55	110	80	517	542	422	480
1/2-20	55	40	85	65	120	90	541	565	443	502
9/16-12	70	55	110	80	150	110	662	713	558	632
9/16-18	80	60	120	90	170	130	752	787	615	697
5/8-11	100	75	150	110	210	160	1110	1160	907	1030
5/8-18	110	85	170	130	240	180	1244	1301	1016	1154
3/4-10	175	130	260	200	380	280	1530	1582	1248	1416
3/4-16	200	140	300	220	420	310	1490	1556	1220	1382
7/8-9	170	125	430	320	600	450	2328	2430	1905	2140
7/8-14	180	140	470	350	670	500	2318	2420	1895	2130
1-8	250	190	640	480	910	680	3440	3595	2815	3185
1-14	280	210	720	540	1020	760	3110	3250	2545	2885

# HYDRAULIC FITTING TORQUE SPECIFICATIONS

Tapered Pipe Thread Size - Assembly turns from Finger Tight (TFFT) for Tapered Threads		TFFT
BSPT (Uncommon)	NPTF (Common)	
1/8-28	1/8-27	2 - 3
1/4-19	1/4-18	2 - 3
3/8-19	3/8-18	2 - 3
1/2-14	1/2-14	2 - 3
3/4-14	3/4-14	2 - 3
1-11	1-11 1/2	1.5 - 2.5
1 1/4-11	1 1/4-11 1/2	1.5 - 2.5
1 1/2-11	1 1/2-11 1/2	1.5 - 2.5
2-11	2-11 1/2	1.5 - 2.5



ORB - SAE J1926 Straight Thread Port Assembly Torques													
		<b>Assembly Torque (+10% -0)</b> **If fitting is being torqued into aluminum or brass, subtract 35% from standard torque value**											
		Non-Adjustable				Adjustable				Plugs			
		ORFS		JIC NPT		ORFS		JIC		Hollow Hex		Hex Head	
Dash Size	SAE Size (UN/UNF)	Ft. lbs. (in. lbs.)	Into Alum. Or Brass Ft. lbs. (in. lbs.)	Ft. lbs. (in. lbs.)	Into Alum. Or Brass Ft. lbs. (in. lbs.)	Ft. lbs. (in. lbs.)	Into Alum. Or Brass Ft. lbs. (in. lbs.)	Ft. lbs. (in. lbs.)	Into Alum. Or Brass Ft. lbs. (in. lbs.)	Ft. lbs. (in. lbs.)	Into Alum. Or Brass Ft. lbs. (in. lbs.)	Ft. lbs. (in. lbs.)	Into Alum. Or Brass Ft. lbs. (in. lbs.)
2	5/16-24	-	-	(85)	(55)	-	-	(60)	(39)	(30)	(19.5)	(85)	(55)
3	3/8-24	-	-	(155)	(101)	-	-	(100)	(65)	(55)	(36)	(155)	(101)
4	7/16-20	(310)	(201.5)	(260)	(169)	(180)	(117)	(180)	(117)	(120)	(78)	(260)	(169)
5	1/2-20	(360)	(234)	(280)	(182)	(360)	(234)	(250)	(162.5)	(170)	(110.5)	(280)	(182)
6	9/16-18	(420)	(283)	(350)	(227.5)	(420)	(273)	(350)	(227.5)	(410)	(266.5)	(350)	(175)
8	3/4-16	60	39	(620)	(403)	60	39	(620)	(217)	60	39	(620)	(403)
10	7/8-14	100	65	85	55	100	65	85	55.25	100	65	85	55
12	1 1/16-12	135	88	135	88	135	88	135	88	135	88	135	88
14	1 3/16-12	175	114	175	114	175	114	175	114	175	114	175	114
16	1 5/16-12	200	130	200	130	200	130	200	130	200	130	200	130
20	1 5/8-12	250	162.5	250	162.5	250	162.5	250	162.5	250	162.5	250	162.5
24	1 7/8-12	305	198	305	198	305	198	305	198	305	198	305	198
32	2 1/2-12	375	244	375	244	375	244	375	244	375	244	375	244

# HYDRAULIC FITTING TORQUE SPECIFICATIONS

## Code 61 and 62 Flange Recommended Bolt Torques

### Steps to Properly Assemble the Flange Port Clamping Bolts:

1. Inspect components to ensure that male and female port threads and sealing surfaces are free of burrs, nicks and scratches, or any foreign material.
2. Lubricate the O-ring
3. Position flange and clamp halves
4. Place lock washers on bolts and insert through clamp halves
5. Hand tighten bolts.
6. Torque bolts in diagonal sequence in small increments to the appropriate torque level \*\*refer to the table below.

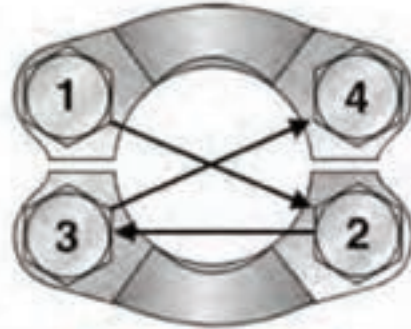

*Flange Bolt Tightening Sequence*

Code 61						Code 62					
Dash Size	Flange Size	Inch Bolt (SAE J518)	Torque ft. lbs.	Metric Bolt (ISO 6162)	Torque N-m	Dash Size	Flange Size	Inch Bolt (SAE J518)	Torque ft. lbs.	Metric Bolt (ISO 6162)	Torque N-m
8	1/2	5/16-18	17 ± 2	M8	24	8	1/2	5/16-18	17 ± 2	M8	24
12	3/4	3/8-16	31	M10	50	12	3/4	3/8-16	31	M10	50
16	1	3/8-16	31 ± 4.5	M10	50	16	1	7/16-14	52	M12	92
20	1-1/4	7/16-14	52	M12	50	20	1-1/4	1/2-13	77	M14	130
24	1-1/2	1/2-13	77	M12	92	24	1-1/2	5/8-11	155	M16	210
32	2	1/2-13	77	M12	92	32	2	3/4-10	265	M20	400
40	2-1/2	1/2-13	77	M12	92						
48	3	5/8-11	155	M16	210						
56	3-1/2	5/8-11	155	M16	210						
64	4	5/8-11	155	M16	210						
80	5	5/8-11	155	M16	210						

<b>37° Flare (JIC) Assembly Torques and FFWR</b>					
SAE Dash Size	Thread Size	Assembly Torque (+10%-0)		Tube Connection FFWR	Swivel Nut or Hose Connection FFWR
		In. lb.	ft. lb.		
-2	5/16-24	35	3	-	-
-3	3/8-24	65	5	-	-
-4	7/16-20	155	13	2 1/2	2
-5	1/2-20	165	14	2	2
-6	9/16-18	265	22	2	1 1/2
-8	5/8-16	505	42	2	1 1/2
-10	7/8-14	720	60	1 1/2	1 1/2
-12	1 1/16-12	1000	84	1 1/2	1 1/4
-14	1 3/16-12	1200	100	1 1/2	1 1/4
-16	1 5/16-12	1415	118	1 1/2	1
-20	1 5/8-12	2015	168	1	1
-24	1 7/8-12	2340	195	1	1
-32	2 1/2-12	3180	265	1	1
-40	3-12	-	-	1	1

## SET-UP & ASSEMBLY



**WARNING:** Some photographs used in the following pages show guards or shields removed for clarification. Never operate machine until these guards or shields are in proper operating position.

**NOTE:** Determine right or left side of the forage box by viewing it from the rear. If instructions or parts lists call for hardened bolts, refer to the Cap Screw Torque Values page to identify.

1. Check the Forage Box for proper assembly and adjustment. Make sure that all bolts are tightened.
2. Properly lubricate the Forage Box before operating. Refer to Lubrication Section of this Operator's Manual for locations.
3. **GEARBOXES:**  
Main Apron Drive Gearbox: Keep the main apron gearbox filled to the oil level plug in cover of gearbox using 85W140 lubricant.  
  
Beater Drive Gearbox: Keep the beater drive gearbox filled to the center of the shafts. Use 80W90 lubricant.
4. Check all lights to make sure that they are functioning properly.

# TRANSPORTING

## TRANSPORT LIGHTING & REFLECTORS

Transport lighting is standard on all Super Duty Models. The lighting system is to be connected to the 7-pin power receptacle (per SAEJ560B) on your tractor. If your tractor is not equipped with the proper receptacle, see your tractor dealer for details. Red reflective safety decals are on the rear of the box for safety.

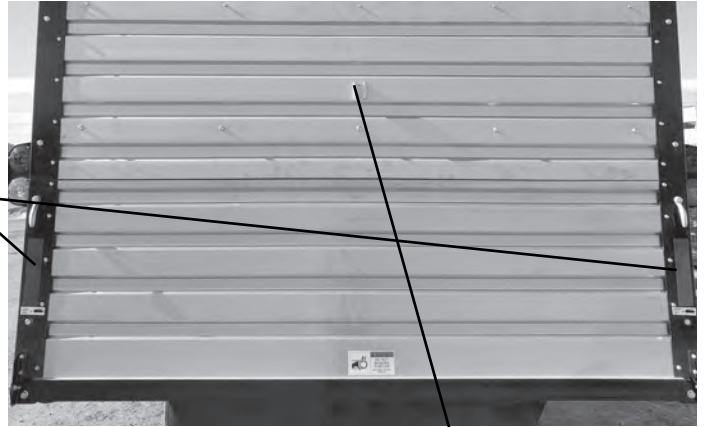

WHEN TRANSPORTING ON THE HIGHWAY OR ROADS, PLACE SMV SIGN IN SOCKET PROVIDED AND REGULARLY CLEAN THE REFLECTIVE TAPE AT THE REAR OF THE FORAGE BOX.

**NOTE:** Obey all state and local laws concerning towed equipment on public roads.

## TOWING ON HIGHWAY

To view beyond the back of the Forage Box when transporting the unit on a public highway, consider obtaining and installing a rearview mirror on your tractor with a wide load mounting bracket.

# PREPARING FOR OPERATION

Check over entire unit carefully before first operation. Tighten bolts, set screws, and chains which may have come loose in handling. Lubricate as explained in the Lubrication Guide. Successful operation will be achieved by periodic adjustments and experience of the operator. Make sure to read and understand all adjustments.

## TRACTION CONNECTIONS

### Front Telescoping PTO Drive

Attach the Forage Box PTO to the tractor PTO shaft, locking it into position. Maintain correct distance between tractor drawbar hitch, tractor PTO and the universal joint at front of unit. This is necessary to prevent overextending the universal joint shaft.

1. Maintain a straight alignment between the Forage Box and the tractor.
2. Maintain a distance of 6"- 12" between the top of the tractor drawbar and the center of the tractor PTO. An 8" distance is standard.

After the correct distance is obtained, the depress the locking collar, against the spring tension, and slide the yoke onto tractor PTO shaft. Release the locking collar and move the yoke ahead or back until the lock engages into the groove on the shaft.

**NOTE:** Do NOT attempt to use a hammer to help in attaching the PTO drive connection.

The tractor drawbar should be adjusted in relation to the tractor PTO shaft as follows:

1. Hitch point of drawbar 14 inches behind tractor PTO shaft.
2. Hitch point of drawbar at least 8 inches, but not more than 14 inches below PTO shaft.
3. Hitch point of drawbar at least 13 inches, but not more than 22 inches above ground level.
4. When unloading, keep the hitch point of drawbar and PTO shaft in a straight line to the Forage Box. Having PTO at an angle will result in a pounding noise and damage to U-joints and the safety clutch.

**IMPORANT! DO NOT operate unless 2" minimum extension is maintained.**

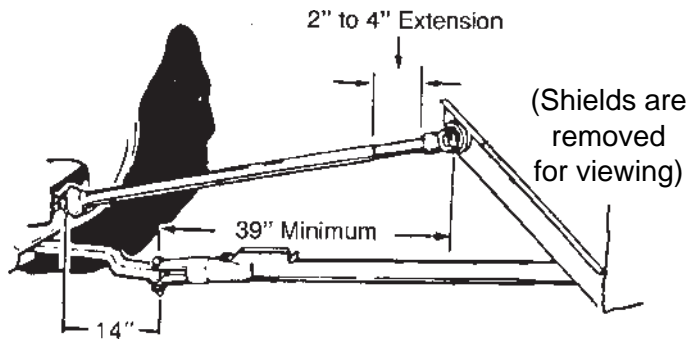

The telescoping PTO drive is designed to rotate freely inside the drive shield tubes. Run the unloading mechanism for several minutes. This will serve as a break-in and as a check that all parts are assembled and lubricated properly.

After you have run the Forage Box for several minutes, check the main apron chains again for proper adjustment, as paint may initially come off the apron chains and chains may loosen. The main apron chains must be taken up evenly before you use the forage box. Check again after the first few loads. The main aprons should be at proper tension at all times. See [Adjustment Section](#) for details.

The Power Take Off Shaft from tractor to box should not be connected for road travel or field operation. Damage may result to the PTO Shaft. A convenient hanger is provided to hold PTO shaft during the time it is not being used to unload.



# OPERATION

## GENERAL INFORMATION

Check entire Forage Box carefully before first operation. Tighten bolts and set screws that might have come loose in transporting. Lubricate if needed as explained in the [Lubrication Chapter](#) in this manual.

## EMERGENCY SHUTDOWN

In case of an emergency, pushing the emergency stop panel, emergency stop bar, or pulling the safety cable will stop cross conveyor, beaters, and main aprons. PTO will continue to rotate. If the Forage Box is plugged with material or a foreign object becomes lodged in the discharge area, disengage the PTO. Stop the tractor engine, remove ignition key, and allow all mechanisms to stop before cleaning or working on the machine. Trip emergency stop occasionally to ensure proper function.



Emergency Stop Panel

Emergency Stop Cable

Disengage Lever

## CONTROLS & SAFETY EQUIPMENT

Forage Boxes are provided with several features for operator safety and convenience.

### Guards & Shields

Whenever possible and without affecting the operation of the Forage Box guards, shields and/or hinged shields have been used on this equipment to protect potentially hazardous areas. In many places, decals are also provided to warn of potential dangers as well as to display special operational procedures.

### PTO Shields

Care must be taken to keep male and female driving elements well-lubricated and free-sliding. The shield surface must be kept dry, as dirt accumulation on them will quickly cause these units to bind and not rotate. If at any time the shields do not turn freely, they should be checked to determine the cause and repaired or cleared. **DO NOT STEP OVER PTO SHAFT. STAY CLEAR OF ROTATING PTO AT ALL TIMES. DO NOT OVEREXTEND PTO.**

Shown is the spring-loaded plastic guard which protects the operator from accidentally being exposed to the beater and apron at the discharge opening during operation of the Forage Box. Keep this guard in proper position at all times when operating forage box.

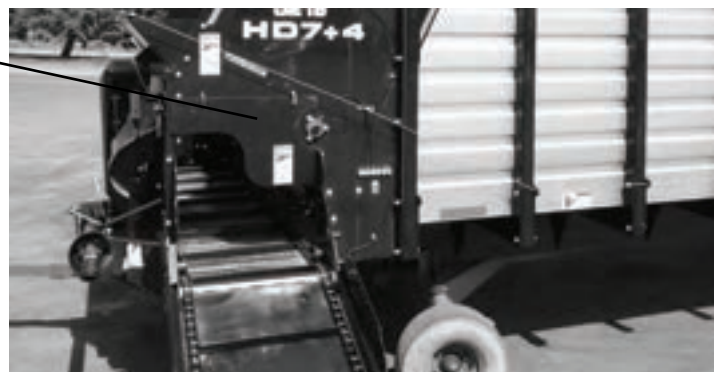

# OPERATION

## OPERATION OF FRONT UNLOAD FORAGE BOX

1. Park the Forage Box on level ground whenever possible during unloading. Lock tractor parking brake.
2. Connect the PTO to a tractor with a 540 PTO ONLY, locking securely in place as stated in the PREPARING FOR OPERATION SECTION.
3. Engage PTO.

**NOTE:** Do NOT exceed the rated 540 RPM operating speed of the Forage Box

4. To engage cross conveyor INTERMITTENTLY, rotate clutch lever clockwise and hold with hand pressure. If hand pressure is removed, the cross conveyor will stop.

5. To engage the cross conveyor CONTINUOUSLY, rotate clutch lever clockwise until it locks in the engage position. Cross conveyor speed is controlled by the tractor RPM only.

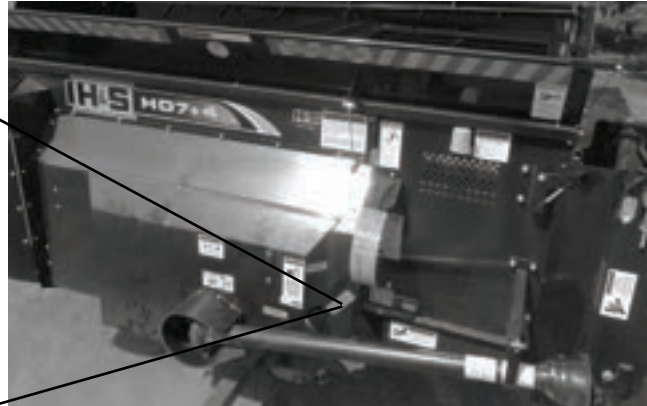

6. Quickly engaging/disengaging beater lever will allow beaters to clear material a little at a time to avoid exceeding blower capacity. This single lever controls both beater engage/disengage and the speed of the main feeder aprons. **CAUTION: DO NOT ENGAGE BEATERS OR MAIN APRONS WHEN CROSS CONVEYOR IS FULL OF MATERIAL OR DAMAGE TO FORAGE BOX WILL RESULT.**

7. When beaters are clear of material, move control lever to apron speed position. Variable speed drive offers you a number of unloading speeds to choose from. Rotating the lever downward starts and gradually increases main apron speed. With experience and depending on the type of forage, you will be able to select a speed which will match your blower capacity. Unloading speed may also be varied by increasing or decreasing engine speed of tractor.

8. If it is necessary to trip the stop mechanism and disengage the Forage Box drive before the box is empty, restart unloading by engaging clutch lever.

9. Clean out position is for cleaning out the forage box at the end of the load.

10. When the Forage Box is empty, move control lever to disengage position. **AFTER UNLOADING, ALWAYS RETURN THE CONTROL LEVER TO THE NEUTRAL POSITION WITH PTO RUNNING.**

11. Disconnect the PTO and place it in the convenient holder for field and road use.



# ADJUSTMENTS

## OVERLOAD PROTECTION

Overload protection is achieved on the PTO driven Forage Box by the slipping of the main drive v-belts or the variable speed main apron belt. Stop all operation and follow the EMERGENCY SHUTDOWN PROCEDURE. Always determine the cause of failure.

## BEATER CLUTCH ADJUSTMENT

Check the beater clutch periodically to ensure that the beaters are completely engaging or disengaging. The beater engage/disengage clutch is properly adjusted when there is 1/8" of clearance between the clutch jaw (B) and the engaging pin (A) when the control lever is in the disengage position. Basic adjustment can be made by positioning the adjustment nut at the end of the control rod.

Place the control arm tight against the nut and adjust the mounting bracket in the slotted holes on the unit until 1/8" is reached. Fine adjustment is made by adjusting the nut on the control rod.

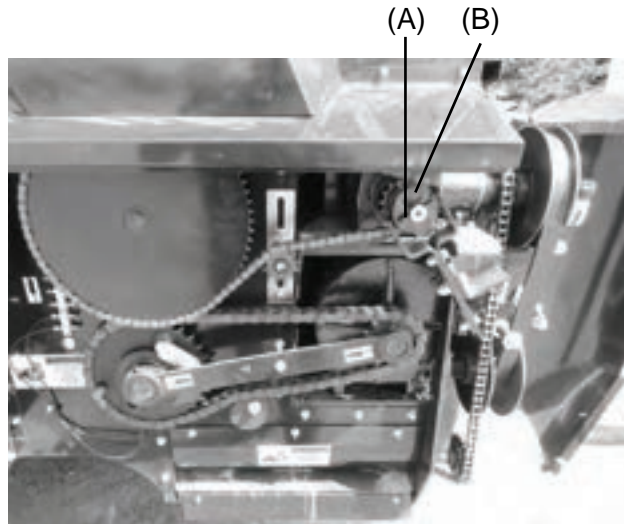

## VARIABLE SPEED DRIVE BELT REPLACEMENT

If it becomes necessary to replace the variable speed drive belt, follow the steps listed below to remove worn belt:

1. Place the control lever in beater disengage position.
2. Open the upper sheaves so belt rests on the drive pins.
3. Remove the belt from the lower sheaves first, and then the upper sheaves.
4. Reverse the above steps when installing new belt.

## VARIABLE SPEED BELT ADJUSTMENT

You should rarely have to adjust the variable speed drive belt. If, however, it becomes necessary to adjust the belt, follow the steps below:

1. Remove the belt as listed in the **BELT REPLACEMENT SECTION**.
2. Move the control lever to the highest apron speed position.
3. Check the upper sheaves, and if the base of sheaves are not tight together, it is necessary to adjust.
4. Remove the bolt from the control rod.
5. Slide the sheaves tight together, being sure that the control yoke is tight against the thrust bearing and sheaves.
6. Adjust the control rod so the hole in control yoke and rod align, then one additional turn.
7. Replace the bolt. Allow sufficient play when tightening, so that the control rod pivots.
8. Place the control lever in beater disengage position and replace the belt.

# ADJUSTMENTS

## MAIN DRIVE BELT ADJUSTMENT

The unloading unit/Forage Box is driven by v-belts as a clutch system. Plugging the cross conveyor will cause the belts to slip. If the belts are constantly slipping, adjust the nut on the shifting rod a half turn at a time, making sure not to overtighten the belt.

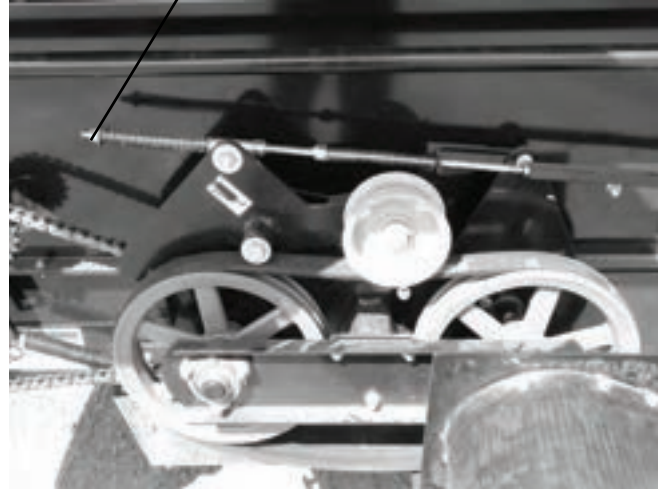

## BEATER DRIVE CHAIN ADJUSTMENT

The beater drive chains have self-adjusting spring tighteners on them. The gearbox to the 1st beater and primary drive chain are tightened with a common spring. Maintain a 1/16" gap between the coils by adjusting the I-Bolt. DO NOT OVERTIGHTEN OR IT WILL CAUSE THE BEATERS TO TURN FROM THE TIGHTNESS OF THE CHAIN. The 2nd and 3rd beater springs should have a 1/16" gap between the coils. When the gap is less, check the condition of the chains, replace or remove a link, offset link, or replace the spring.

## DRIVE CHAIN IDLERS

### Drive Chain Idler - Front Unload

A chain tightener is provided to adjust the tension on the roller chain between the gearbox drive sprocket and the main apron drive shaft. The chain is properly adjusted when there is a slight deflection at the center of the chain.

**NOTE:** *If an idler fails to maintain proper tension, replace the worn chain.*

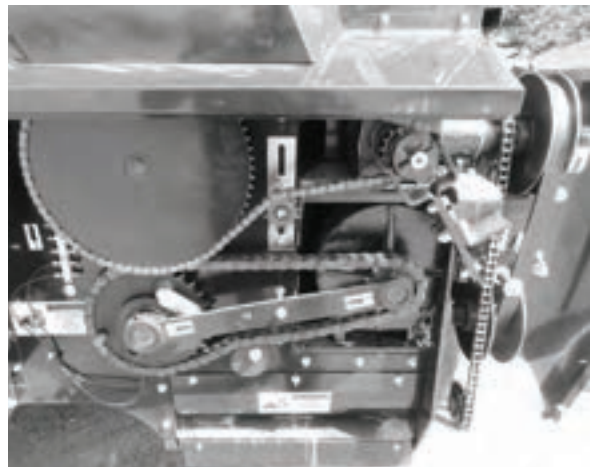

# ADJUSTMENTS

## CROSS CONVEYOR ADJUSTMENT

Proper tension should be maintained on cross conveyor chain during operation. To adjust the cross conveyor spring-loaded tightener bolts, move the adjusting nuts on tightener bolts until proper tension on chain is reached. The chain is properly adjusted when the compression spring overall length is 1-1/2". Adjust both sides equally when the cross conveyor extension is down in the working position.

**NOTE: Make sure that the cross conveyor extension is in the UNLOAD position when making adjustments.**



## MAIN APRON ADJUSTMENT

Four main feeder apron adjustment bolts are located under the drop-down rear tailgate at the rear of the Forage Box. Remove the handle nuts to open the drop-down rear tailgate to access the adjustment bolts. All apron chains must be taken up evenly before you use the Forage Box. Check again after the first few loads. The main feeder aprons should be at proper tension at all times. Tighten the full thread bolts to adjust the aprons. Aprons are properly adjusted when two cross slats, or about 3' of chain, lift off the chain return slides from the rear of the box. Maintain this tension when operating the Forage Box.

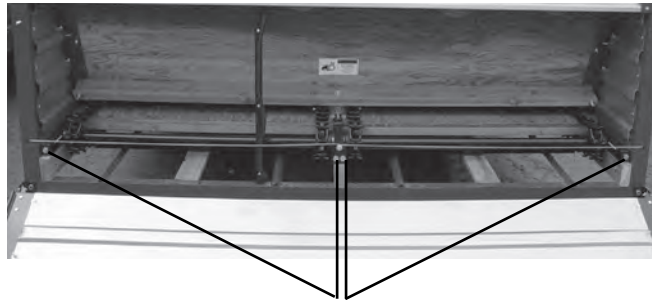

Main Feeder Apron Adjustment Bolts

# SERVICE

## ENTERING FORAGE BOX

If you plan to manually unload the Forage Box utilizing cross conveyor, the following two-man procedure must be followed. **NEVER ATTEMPT THIS PROCEDURE ALONE. THE PERSON OUTSIDE OF FORAGE BOX OPERATING CONTROLS MUST NOT LEAVE CONTROLS.**

1. Place control lever in beater disengage position.
2. Disengage tractor PTO, shut off tractor, and remove the ignition key.
3. Disengage tractor hydraulics, shut off tractor, and remove the ignition key.
4. Remove variable speed drive belt. This will prevent main aprons from moving.
5. Remove connector link from beater drive roller chain and remove chain from sprockets.  
**CAUTION: BEATERS ARE NOW FREE TO ROTATE.**
6. Using a short piece of chain with hooks, secure top beater to center beater. See picture below.
7. Wrap chain around bar of third beater and top bar of second beater. Secure chain together as tight as possible to eliminate beaters from rotating in either direction. Keep excess chain out of cross conveyor chamber. **NOTE:** Hook chain properly and securely to prevent unhooking during this procedure.
7. Using extreme caution, first person may now climb over beaters.
8. When first person is clear of beaters, second person may start tractor and engage PTO to operate cross conveyor.
9. Before first person attempts to leave forage box, second person must disengage tractor PTO, shut off tractor, and remove the ignition key.
10. When forage box is clear of people, remove safety chain from beaters, reinstall drive belt and beater drive chain. Adjust tightener on roller chain.



## SERVICE

### CROSS CONVEYOR CLEAN-OUT PAN

1. Shut off tractor and remove ignition key.
2. Remove the (3) wing nuts.
3. Pull the pan out.
4. Remove any material in the conveyor area.
5. Reinstall the (3) wing nuts.

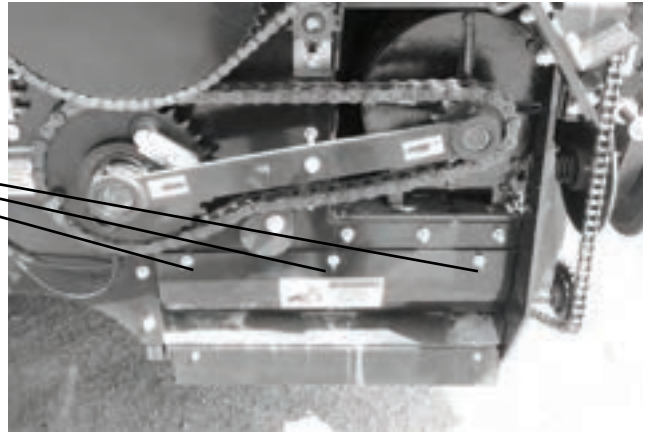

# **OPTIONS**

## **4th BEATER**

A 4th Beater Option is available.

## **HYDRAULIC DRIVE**

A Hydraulic Drive Drive Option in lieu of a PTO is available.

## **LONG PTO**

A Long PTO Option in lieu of the standard PTO is available for customers with quick hitches.

## **HYDRAULIC CYLINDER KIT FOR 2' EXTENSION**

A Hydraulic Cylinder Kit is available for the standard 2' extension.

## **ELECTRIC CAB CONTROLS**

An Electric Cab Control Option is available to control the main apron instead of a manual lever.

# **LUBRICATION**

## **GENERAL INFORMATION**

**IMPORTANT:** *Catch and dispose of fluid per local waste disposal regulations whenever service is performed on hydraulic components, valves, cylinders, hoses, etc.*

## **GREASING**

There are numerous grease fittings on the Forage Box. Become familiar with all lubrication points and establish a routine to ensure complete lubrication of the Forage Box. Lubricating properly and often (every 10 hours) with a high-quality grease will prolong the life of the forage box. Replace any missing or plugged grease fittings. Wipe dirt from the fittings before greasing to prevent the dirt from being forced into the bearing or pivot. Grease should come out around the shaft on sleeve type bearings. On the sealed ball bearings, grease should be added slowly until a slight bead forms at the seal, indicating the correct amount of lubricant. To minimize dirt build-up, avoid excessive greasing. After greasing, wipe off the excess grease from around the outside of the bearings to prevent the accumulation of chaff and grit.

## **GEARBOXES**

Main Apron Drive Gearbox: Keep the main apron gearbox filled to the oil level plug in cover of gearbox using 85W140 lubricant.

Beater Drive Gearbox: Keep the beater drive gearbox filled to the center of the shafts. Use 80W90 lubricant.

## **DRIVE CHAINS**

Lubricate the drive chains with a light machine oil. Keep chains aligned with sprockets; this will lengthen the life of the sprockets and chain. Lubricate chains often.

## **PTO ASSEMBLY**

Keep the male and female shafts of the PTO well-lubricated and free-sliding. Failure to observe this precaution will result in excessive pressure being required to collapse or extend the assembly while subject to operating torque. This excessive force may damage the main shaft bearings. Never lubricate the shield surfaces. The shield surfaces must be kept dry, as dirt accumulation on them will cause the shields to bind and not rotate. Dented or damaged PTO shields will also result in excessive force being applied against the jackshaft. Damaged shields also cause difficulty when installing the assembly. If at any time the shields do not turn freely, they should be checked to determine the cause and repaired or cleaned. To avoid damage to the main drive bearings, avoid turning sharp corners while PTO is running. Start and Stop PTO slowly to avoid damage to the drive line.

# LUBRICATION

(1) on idler sprocket.

(1) on beater drive clutch

Remote Zerk bank for fittings on beaters & apron drive shaft.

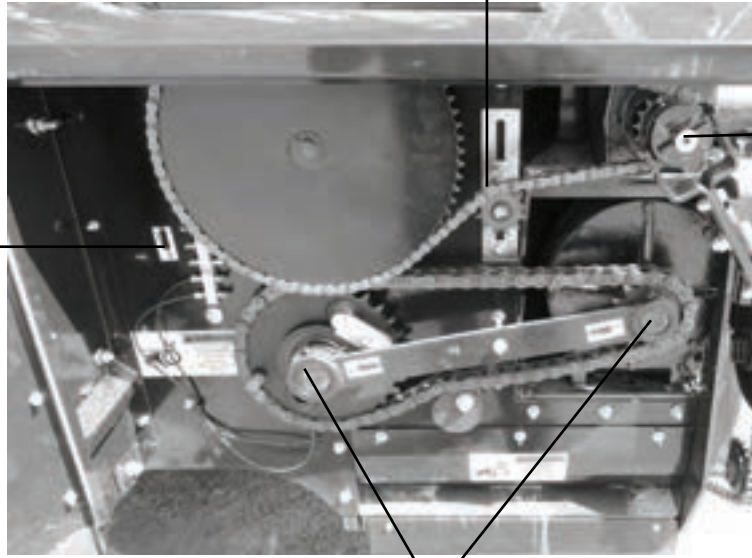

(1) on each end of brace

One on each side of the variable drive outer upper sheave.

(1) on variable drive inner lower sheave

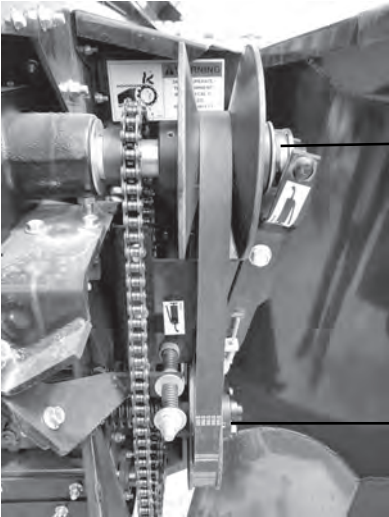

(1) on Clutch Idler Pivot Shaft (Under Shield)

(1) on Clutch Control Handle (Under Shield)

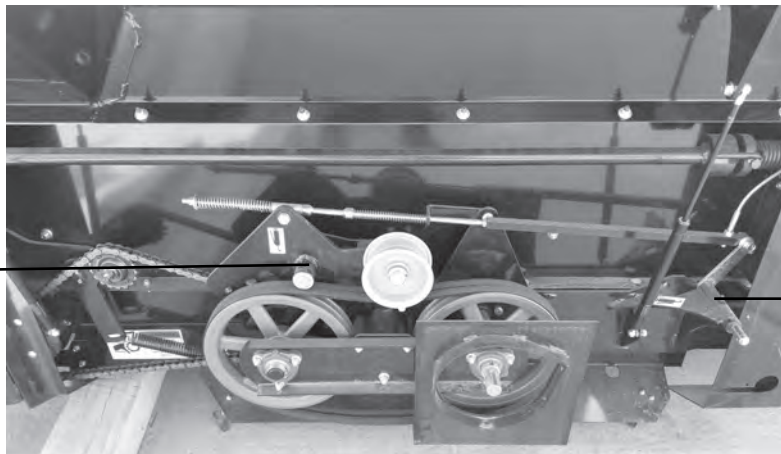



# LUBRICATION



(2) One each end of the PTO at U-joint.



Remote Zerk bank for fittings on beaters & apron drive shaft.



(4) One on each main apron rear idler sprocket

# DECAL LOCATION

Your H&S Forage Box was manufactured with operator safety in mind. Located on the Forage Box are various decals to aid in operation and to warn of danger or caution areas. Pay close attention to all the decals on your Forage Box.



**DO NOT REMOVE ANY OF THESE DECALS. IF DECALS ARE LOST, DAMAGED, OR IF YOUR SUPER DUTY IS REPAINTED, REPLACE DECALS.  
REMEMBER: DECALS ARE FOR YOUR PROTECTION AND SAFETY.**

Listed below are the decals on your Forage Box. These decals may be ordered individually by part number.

<u>Part #</u>	<u>Quantity</u>	<u>Description</u>
311	1	Patent Decal
1494A	4	Do not operate this machine if this decal is exposed. Replace safety shields.
1494B	3	Do not remove shields - moving parts inside.
1494C	4	Stay Clear - Moving parts under this area.
1494F	1	Never enter forage box unless the safety chain precautions are followed.
1494H	3	Stay Clear of beater and/or cross conveyor if power source or PTO is running.
1494K	2	Do not remove shields - moving parts inside.
1494L	1	Do not operate (Rotating Driveline)
1494P	1	Maintain safe clearance from electrical power lines.
1494Q	1	When operating forage box as a rear unload, operator should remain in tractor
2495	1	Keep Children Away
5696D	1	Disengage
5696E	1	Engage
5896B	1	Rotating driveline.
5896C	1	To prevent serious injury or death never operate unless emergency stop functions
8509	1	RH Yellow Strip
8510	1	LH Yellow Strip
11599	1	Do not go near leaks
12502A	1	Stay Clear of Extension When Raising or Lowering
31300	1	Insert Pin Until Flush
56713	1	Help avoid injury - Read and understand the operators manual
56842	1	Entering Forage Box
80251	2	Extra Capacity Decal
80252	3	H Metal Sign
80253	3	& Metal Sign
80254	3	S Metal Signs
87663	2	Model Number Decal 19'
80249	2	H&S HD7+4 Decal Front
80250	2	HD7+4 Side Decal
54033	1	3" Made in USA
66076	5	Grease Zerks Behind Shield
84044	1	FEMA Decal
84045	1	H&S Since 1967
92706	2	Stay Clear of Extension when Raising or Lowering
093466	1	Maximum Operating Speed 540 RPM
093020	13	Grease zerk decal
093366	1	Operators Manual
1033185	1	Emergency Stop
1043185	1	Emergency Stop
1202177	2	Push to Stop

# DECAL LOCATION

<u>Part #</u>	<u>Quantity</u>	<u>Description</u>
1191	1	Speed Control Decal
742191	1	Clean Out Instructions
DCAMB	5	Amber Reflective Decal
DCRED	3	Red Reflective Decal

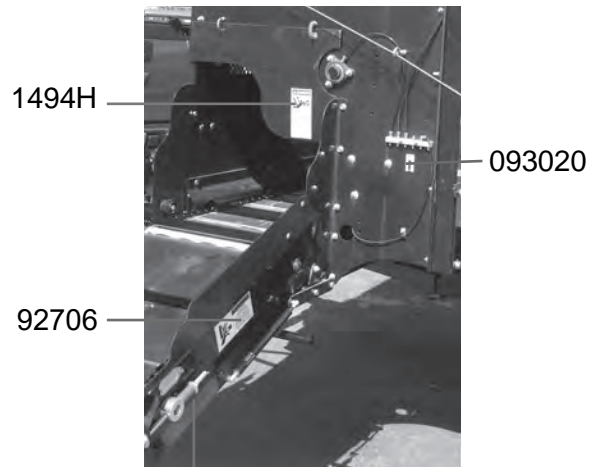
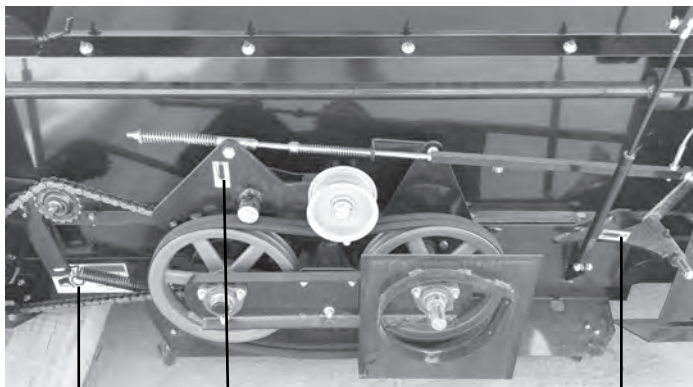
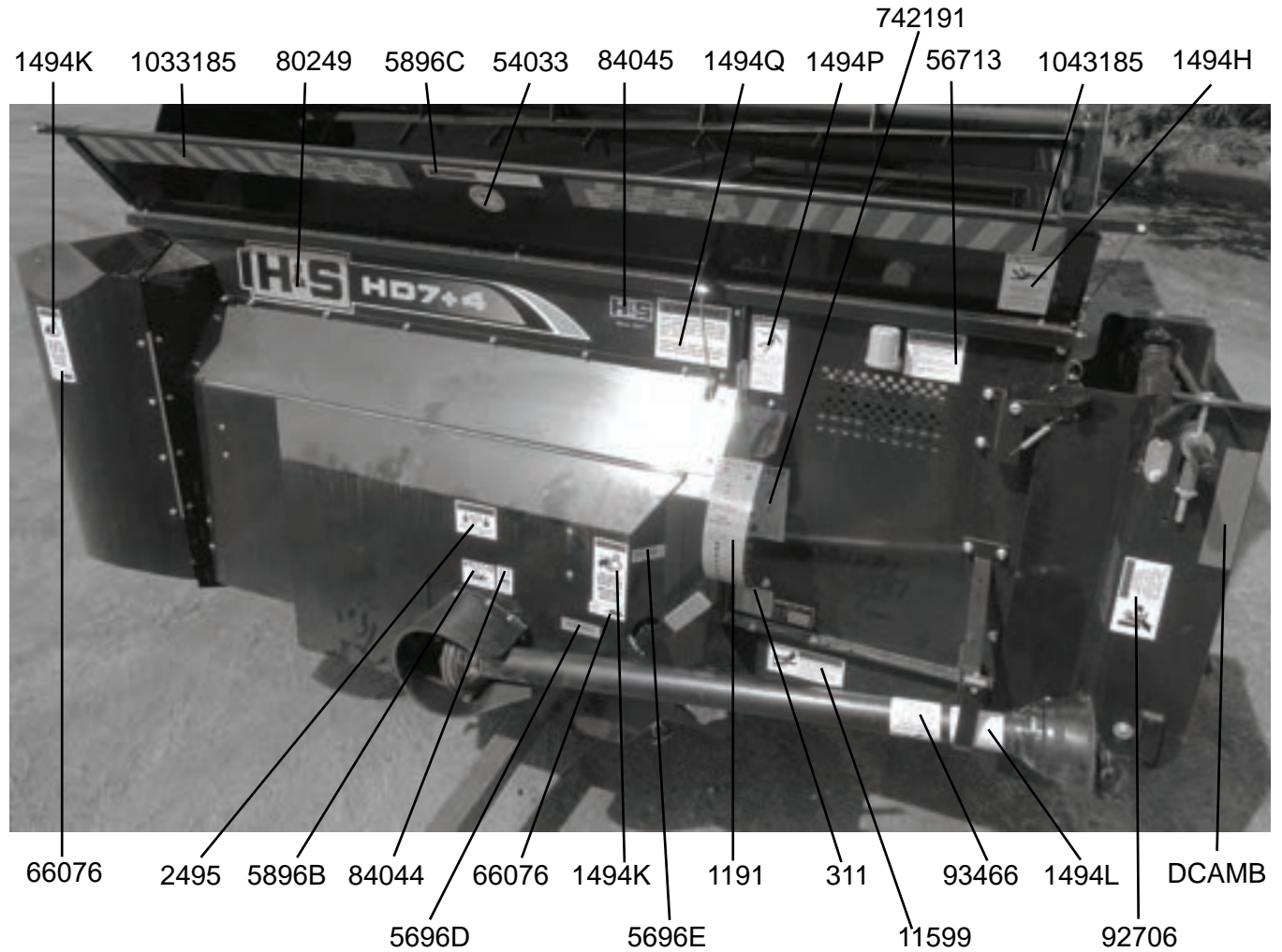

DCRED

# DECAL LOCATION

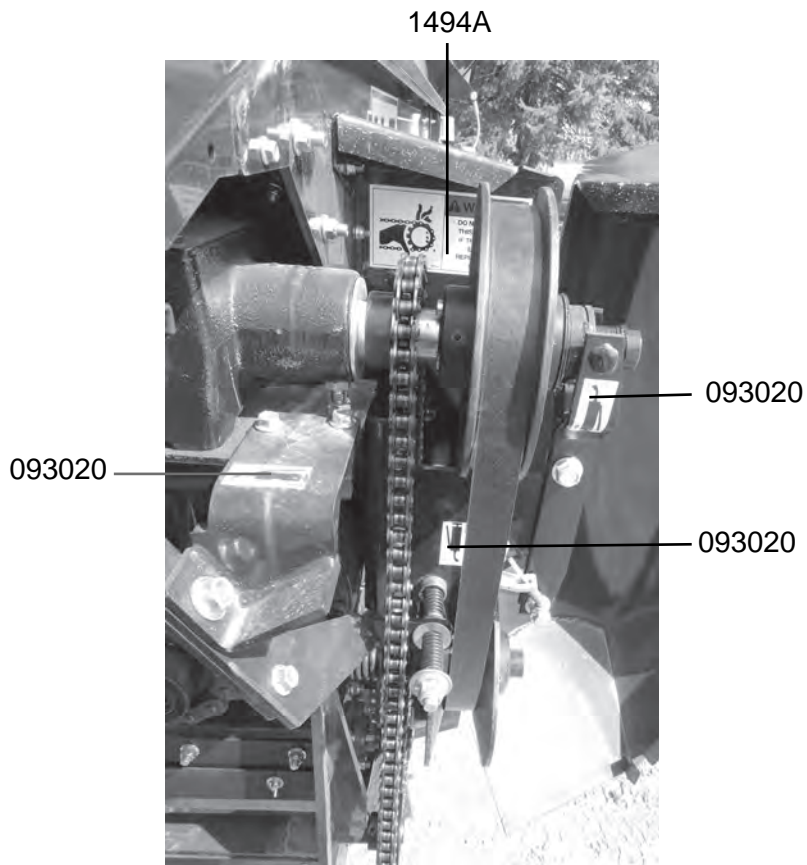
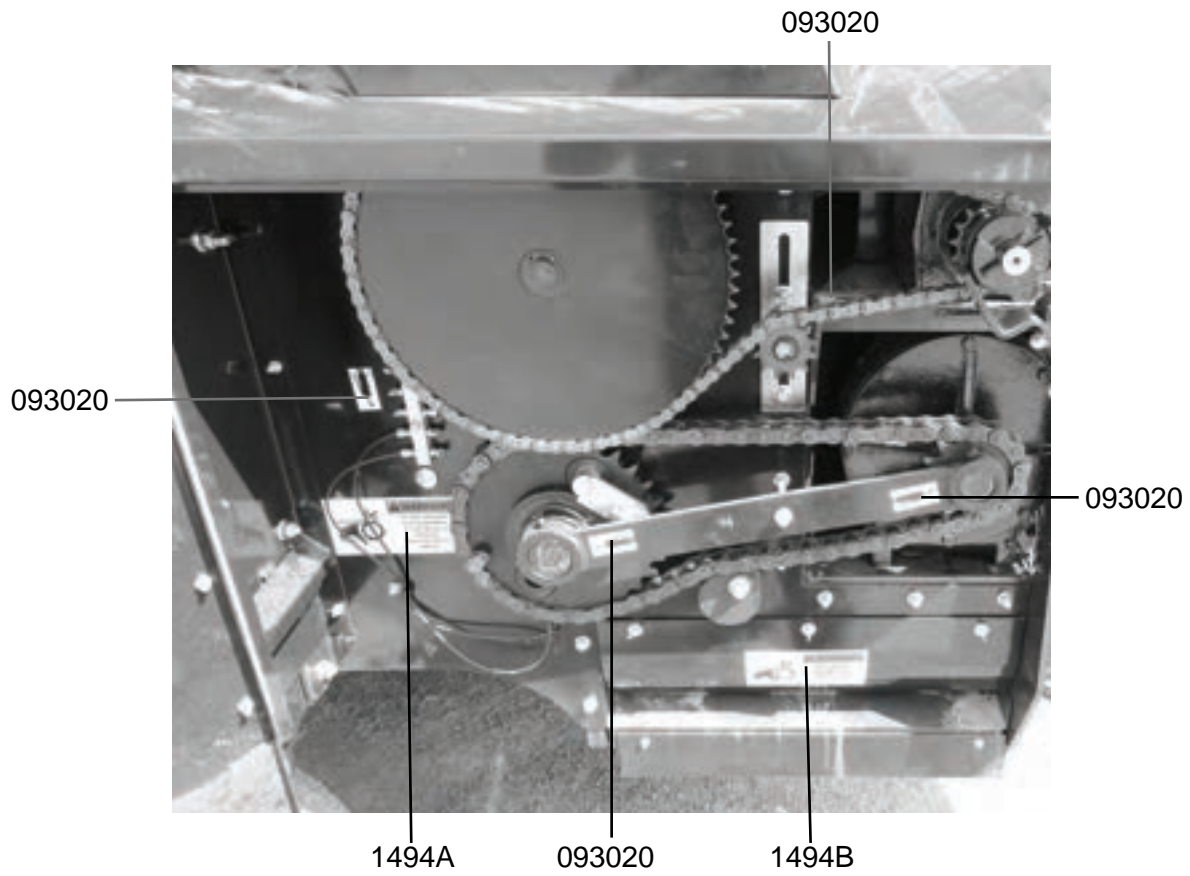

# DECAL LOCATION

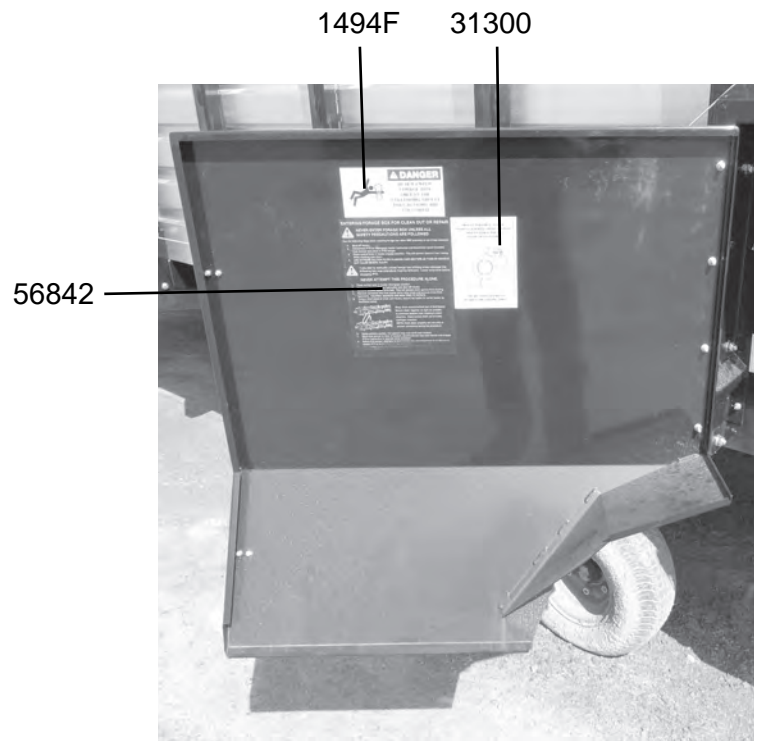
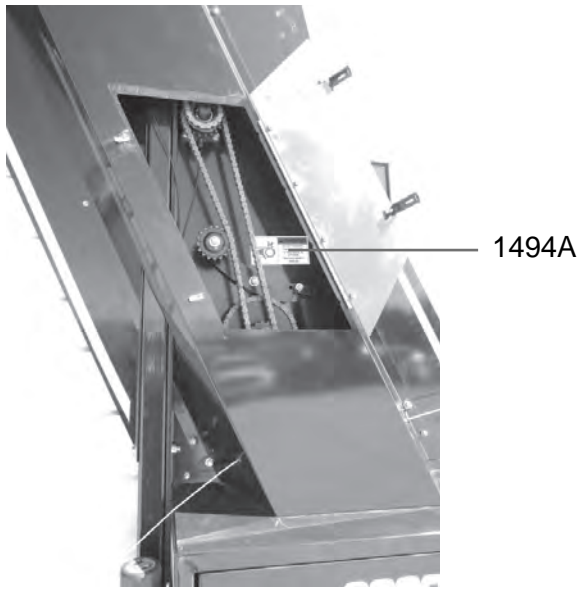
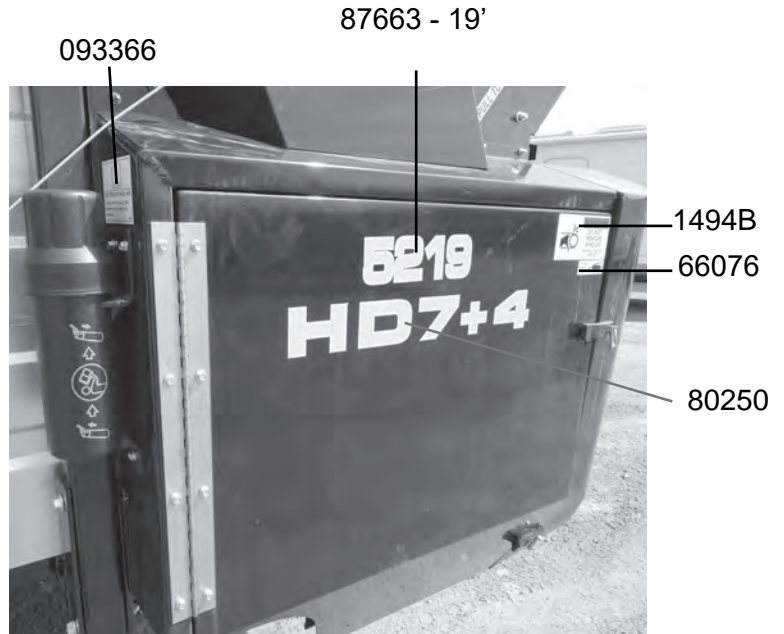

# DECAL LOCATION

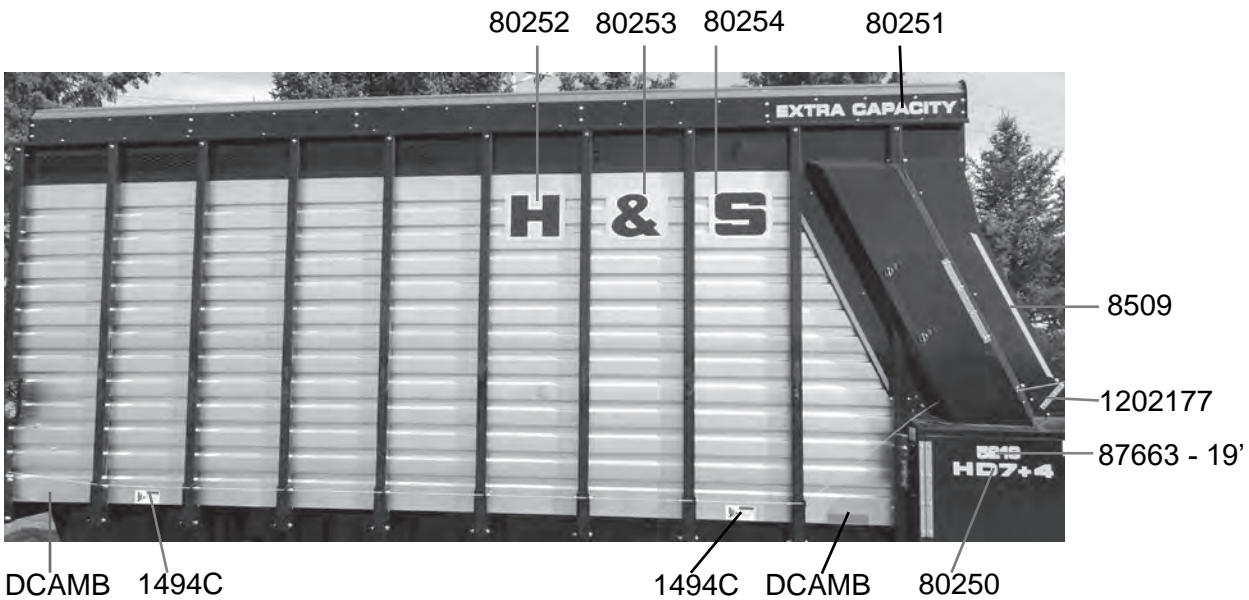
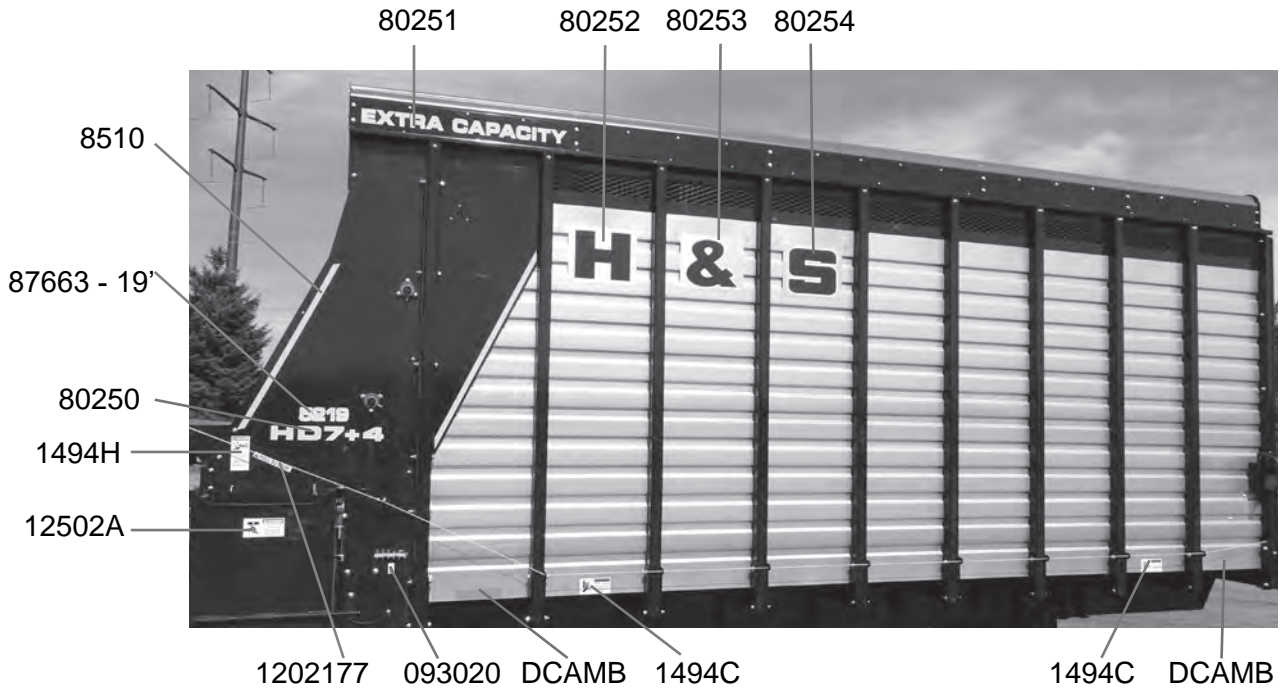

# DECAL LOCATION

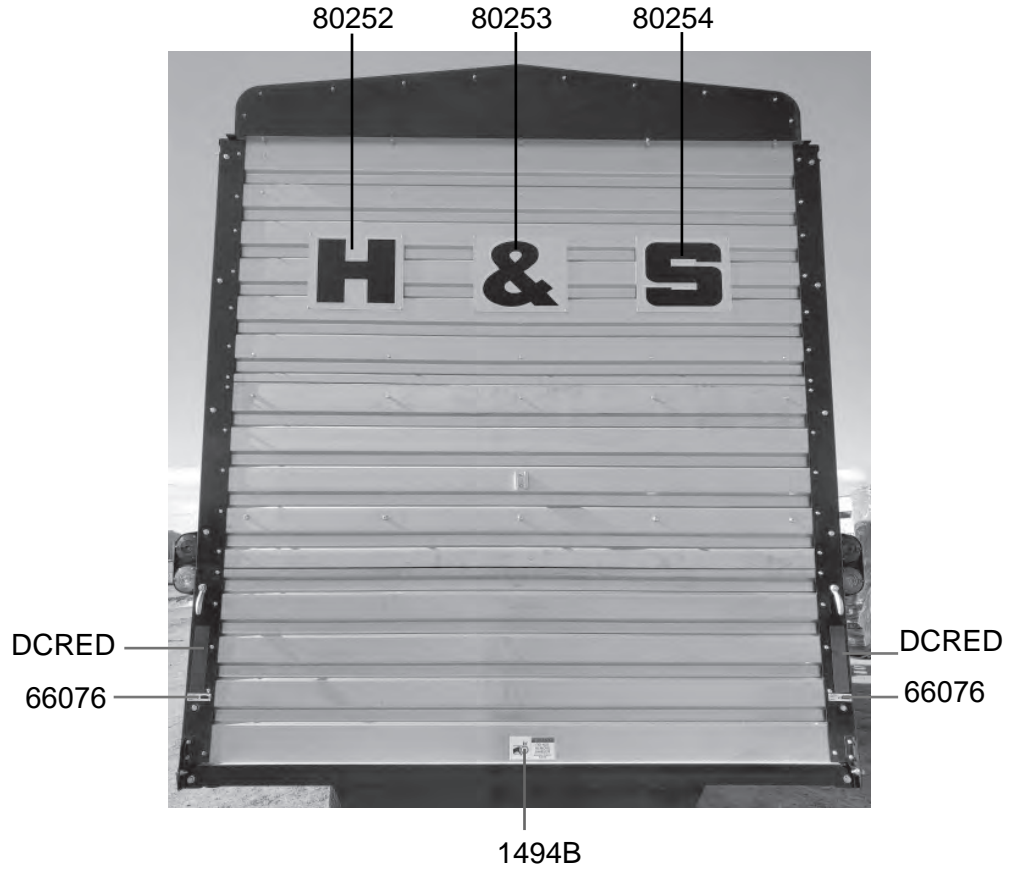







H&S MFG. CO.  
products approved  
for the  
FEMA  
SEAL OF QUALITY



Manufactured by:  
H&S MANUFACTURING CO., INC.  
2608 S. HUME AVE. MARSHFIELD, WI 54449  
(715) 387-3414 | [hsmfgco.com](http://hsmfgco.com)

