

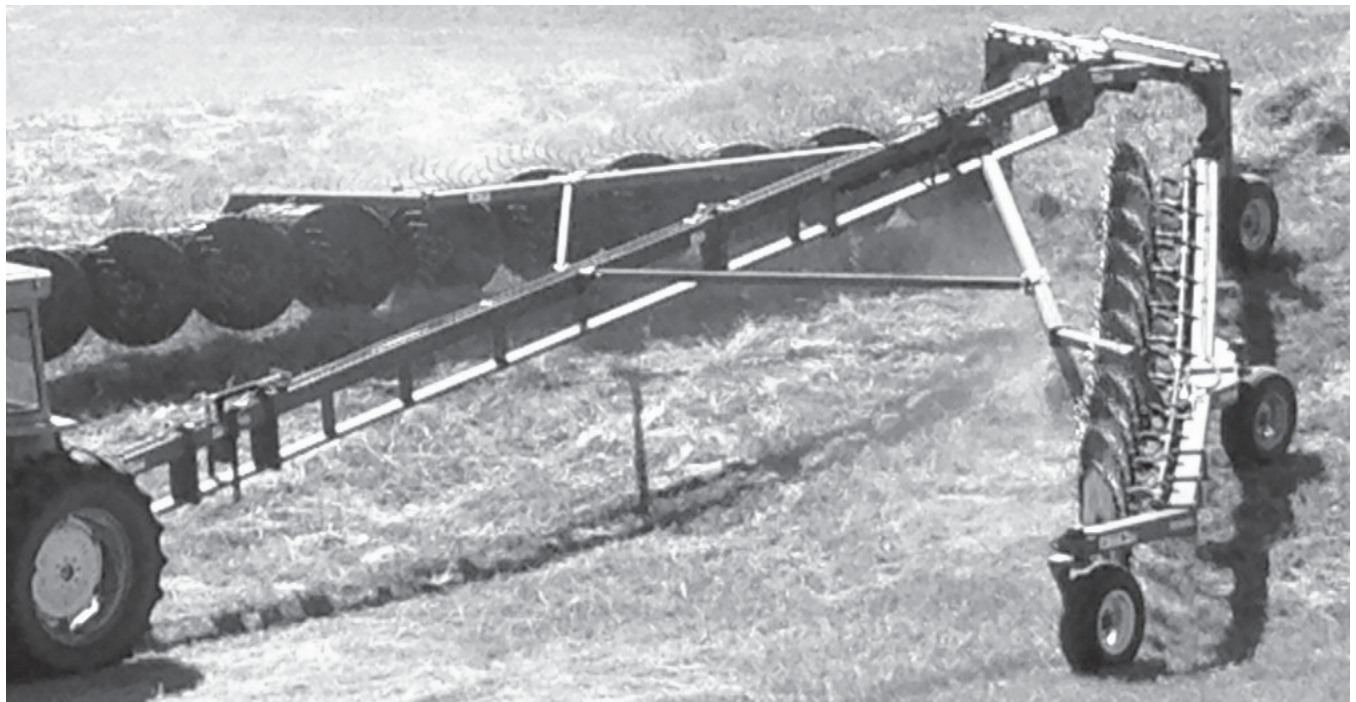

6118/6120/6122

OPERATOR'S MANUAL



WARNING

READ AND UNDERSTAND THIS MANUAL BEFORE OPERATING THIS EQUIPMENT. UNSAFE OPERATION OR MAINTENANCE OF THIS EQUIPMENT CAN RESULT IN SERIOUS INJURY OR DEATH.

Revision #01

6118 Starting Ser. #510001

6120 Starting Ser. #511001

6122 Starting Ser. #512008

HSMFG0115

Part #60553

Manufactured By
H&S MANUFACTURING CO., INC.

P.O. BOX 768 (715) 387-3414 FAX (715) 384-5463
MARSHFIELD, WISCONSIN 54449

CONTENTS

Warranty & Warranty Registration Card	1-2
Manufacturers Statement	2
Dealer Pre-Delivery Checklist	3
Dealer Delivery Checklist	5
Safety Information - Be Alert Symbol	7
Safety Information - Explanation of Safety Signs	8
Safety Decals	9
Safety Information - Warning - Owner Must Read and Understand	10
Cap Screw Torque Values	11
Set-up & Assembly	12
Transporting	13
Preparing for Operation	14
Operation & Adjustments	15-16
Optional Equipment	17
Lubrication Guide	18-19
Decal Location	20-25
Trouble Shooting	26
Service Notes	27-28

WARRANTY

H&S WARRANTY

H&S Manufacturing Co., Inc. ("H&S") warrants this product to be free from defect in material and workmanship. Except as noted below, this warranty term is twelve (12) months from the date of delivery of the product to the original purchaser by an authorized H&S dealer. Under this warranty, H&S will repair or replace, at its option, any covered part which is found to be defective in material or workmanship during the applicable warranty term. In no case will the covered repair cost of a part or parts exceed the replacement cost of that part. Warranty service must be performed by H&S or a dealer authorized by H&S to sell and/or service the product involved, which will use only new or remanufactured parts or components furnished by H&S. This warranty includes approved parts and labor to fix the product but does not include, and the purchaser is responsible for, any service call and/or transportation of the product to and from the dealer's place of business, for any premium charged for overtime labor requested by the purchaser, and for any service work not directly related to any defect covered under this warranty. This warranty includes only those components of the product manufactured by H&S. Warranty for any component not manufactured by H&S including, but not limited to, engines, batteries, tires, rims, hydraulic motors, pumps, etc. are covered by the warranty, if any, provided separately by their respective manufacturers.

This warranty in all its parts, is extended solely to the original purchaser of the product, is terminated upon any subsequent transfer or sale from or by the original purchaser and extends no third party benefits or rights whatsoever.

The warranty term for any product used in any commercial, custom, for hire or rental application, is limited to six (6) months from the date of delivery of the product to the original purchaser or the first day of service, whichever comes first, by an authorized H&S dealer.

Floor and side panels utilized in H&S Manure Spreaders are warranted, to the original purchaser, to not wear through or delaminate for 10 years when used to spread normal agricultural manure. The frame, sides, end, floor and roof of forage boxes are warranted to not wear or rust through for 10 years when the forage box is used to transport freshly chopped forage. These specific warranties include only replacement of any defective panel part without any allowance for labor beyond the terms of the standard H&S 12 month warranty.

For commercial, custom for hire, or rental application, warranty is limited to 6 months from the date of delivery to the original purchaser, or the first day in service, whichever is earlier.

This warranty does not include: (1) Any product that has been altered or modified in ways not approved by H&S; (2) Depreciation or damage caused by normal wear, misuse, improper or insufficient maintenance, improper operation, accident or failure to follow the product Operator's Manual recommendations and product decal recommendations; (3) Normal maintenance parts and service; (4) Repairs made with parts other than those available from H&S or performed by anyone other than H&S or a dealer authorized by H&S to sell and/or service the product involved.

To secure warranty service the purchaser must report the product defect to a dealer authorized by H&S to sell and/or service the product involved within the applicable warranty term together with evidence of the warranty start date and make the product available to that dealer within a reasonable period of time.

HERE ARE NO WARRANTIES WHICH EXTEND BEYOND THE DESCRIPTION ON THE FACE OF THIS WARRANTY. H&S and the companies affiliated with it makes no warranties, representations, or promises, express or implied, as to the performance or freedom from defect of its products other than those set forth above and **NO IMPLIED WARRANTY OF MERCHANTABILITY, FITNESS OR FITNESS FOR A PARTICULAR PURPOSE IS MADE. IN NO EVENT WILL THE DEALER, H&S OR ANY COMPANY AFFILIATED WITH H&S BE LIABLE FOR INCIDENTAL OR CONSEQUENTIAL DAMAGES.** The **ONLY REMEDY** the purchaser has in connection with the breach of performance of any warranty on H&S products are those set forth above.

The selling dealer has no authority to make any representation or promise on behalf of H&S, or to modify the terms or limitations of this warranty in any way.

12/13

**FILL OUT
AND MAIL
IMMEDIATELY
TO MAKE
WARRANTY
EFFECTIVE**



WARRANTY REGISTRATION

Date of Purchase _____

Purchaser _____ Address _____

City _____ State _____ Zip _____

Product _____ Model# _____ Serial# _____

Dealer _____ Address _____

City _____ State _____ Zip _____

Signature of Original Buyer

MANUFACTURER'S STATEMENT

Your New H&S Product has been manufactured of the finest quality materials and components. The performance you get from your machine is largely dependent upon how well you read and understand this manual and apply this knowledge. There is a right and a wrong way to do everything. Please do not assume that you know how to operate and maintain your Machine before reading this manual carefully. Keep this manual available for ready reference.

IMPORTANT!

Tear on the dotted line, provide the information requested on the card. The H&S Warranty is valid **“only”** after this card is received and recorded at H&S Manufacturing Co., Inc. Mail at once. No postage is required in the U.S.A.



NO POSTAGE
NECESSARY
IF MAILED
IN THE
UNITED STATES

BUSINESS REPLY MAIL

FIRST CLASS MAIL Permit No.195 Marshfield, WI 54449

POSTAGE WILL BE PAID BY ADDRESSEE

H&S Manufacturing Co., Inc.
PO Box 768
Marshfield, WI 54449-9963



DEALER PRE-DELIVERY CHECK LIST

AFTER COMPLETION, DEALER SHOULD REMOVE AND RETAIN FOR RECORDS

After the rake has been completely set-up, check to be certain it is in correct operating order before delivering to the customer. The following is a list of points to inspect. Check off each item as you have made the proper adjustments and found the item operating satisfactorily.

- Rake was not damaged in shipment. Check for dents and loose or missing parts. Report damage immediately to H&S Manufacturing Co., Inc.
- Rake has been correctly assembled according to instructions in this manual. Wheel nuts and all other fasteners are tightly secured.
- All bolts and fasteners are tight.
- All grease fittings have been lubricated. See Lubrication Chapter of this manual for details.
- Hoses and fittings are properly attached and there are no visible leaks.
- All mechanisms are operating trouble free.
- Rake wheels touch ground in unison when lowered into position. (Rake setting level)
- Wheels are properly mounted.
- Tires are inflated to correct pressure.
- Decals are in place and legible.

Model Number _____

Serial Number _____

Dealer's Name _____

Inspection Date _____

Signature of Pre-Delivery Inspector _____

(Remove Dealers File Copy At Perforation)

Intentionally Left Blank

DEALER DELIVERY CHECK LIST

AFTER COMPLETION, DEALER SHOULD REMOVE AND RETAIN FOR RECORDS

This check list that follows is an important reminder of valuable information that should be passed on to the customer at the time this Rake is delivered.

Check off each item as you explain it to the customer.

This delivery check list, when properly filled out and signed assures the customer that the Pre-delivery service was satisfactorily performed.

- Explain to the customer that the pre-delivery inspection was made.
- Explain to the customer all the safety precautions they must exercise when operating this unit.
- Explain raking and windrow width adjustments.
- Explain to customer that regular lubrication is required for proper operation and long life of machine.
- Show customer the lubrication section of Owner's Manual.
- Give the customer Owner's Manual and make sure they read and understand all operating and service instructions.
- Have the customer sign a completed "Warranty Registration", and mail it.

Date Delivered _____

Dealer's Name _____

By _____

Signature of Original Buyer _____

Note: Warranty is not valid until warranty card is completed and returned to H&S Mfg. Co., Inc.

Intentionally Left Blank

SAFETY INFORMATION



**BE
ALERT!**

**YOUR SAFETY
IS INVOLVED.**

THIS SYMBOL IS USED THROUGHOUT THIS BOOK WHENEVER YOUR PERSONAL SAFETY IS INVOLVED. TAKE TIME TO BE CAREFUL. REMEMBER: THE CAREFUL OPERATOR IS THE BEST OPERATOR. MOST ACCIDENTS ARE CAUSED BY HUMAN ERROR. CERTAIN PRECAUTIONS MUST BE OBSERVED TO PREVENT THE POSSIBILITY OF INJURY OR DAMAGE.

H&S MANUFACTURING CO., INC.

SAFETY INFORMATION

RECOGNIZE SAFETY INFORMATION

This is the safety-alert symbol. When you see this symbol on your machine or in this manual, be alert to the potential for personal injury.

Follow recommended precautions and safe operating practices.



UNDERSTAND SIGNAL WORDS

A signal word; DANGER, WARNING, or CAUTION - is used with the safety-alert symbol. DANGER identifies the most serious hazards.

Safety signs with signal word DANGER or WARNING are typically near specific hazards.

General precautions are listed on CAUTION safety signs.



WARNING



CAUTION



FOLLOW SAFETY INSTRUCTIONS

Carefully read all safety messages in this manual, and all safety signs on your machine. Follow all recommended precautions and safe operating procedures.

Keep signs in good condition. Immediately replace any missing or damaged signs.

OBSERVE MAXIMUM TRANSPORT SPEED

The maximum transport speed for this implement is 32 km/h (20 m.p.h.).

Some tractors are capable of operating at speeds that exceed the maximum transport speed of this implement. Regardless of the maximum speed capability of the tractor being used to tow this implement, do not exceed the implement's maximum transport speed.

Exceeding the implements maximum transport speed can result in:

- * Loss of control of the tractor/implement combination
- * Reduced or no ability to stop during braking
- * Implement tire failure
- * Damage to the implement structure or its components

Use additional caution and reduce speed when towing under adverse surface conditions, when turning, and when on inclines.

Do not attempt transport if the fully loaded implement weighs more than 1.5 times the weight of the tractor.



SAFETY INFORMATION

WARNING
<p>HELP AVOID INJURY</p> <ul style="list-style-type: none"> • READ & UNDERSTAND THE OPERATORS MANUAL PROVIDED WITH THIS MACHINE. IF MISPLACED CALL H & S MANUFACTURING AT 715-387-3414 WITH MODEL AND SERIAL NUMBER. • UNDERSTAND ALL SAFETY WARNINGS AND FUNCTION OF CONTROLS. • KEEP SAFETY DEVICES IN PLACE AND WORKING. • KEEP YOURSELF AND OTHERS WELL CLEAR OF MOVING PARTS. • DISCONNECT ALL POWER BEFORE SERVICING OR CLEANING THIS MACHINE. • DO NOT EXCEED 20 MPH
72203A

WARNING	
	<p>STAY CLEAR</p>
1906C	

	<table border="1" style="width: 100%; border-collapse: collapse;"> <tr> <td style="background-color: #cccccc; text-align: center; padding: 5px;"> DANGER </td> </tr> <tr> <td style="text-align: center; padding: 5px;"> <p>STAY CLEAR OF RAKE WHEN OPENING OR CLOSING.</p> <p>FAILURE TO HEED THIS WARNING MAY RESULT IN PERSONAL INJURY OR DEATH</p> </td> </tr> <tr> <td style="text-align: center; padding: 5px;"> <p>KEEP CLOTHING, YOURSELF AND OTHERS WELL CLEAR.</p> </td> </tr> </table>	DANGER	<p>STAY CLEAR OF RAKE WHEN OPENING OR CLOSING.</p> <p>FAILURE TO HEED THIS WARNING MAY RESULT IN PERSONAL INJURY OR DEATH</p>	<p>KEEP CLOTHING, YOURSELF AND OTHERS WELL CLEAR.</p>
DANGER				
<p>STAY CLEAR OF RAKE WHEN OPENING OR CLOSING.</p> <p>FAILURE TO HEED THIS WARNING MAY RESULT IN PERSONAL INJURY OR DEATH</p>				
<p>KEEP CLOTHING, YOURSELF AND OTHERS WELL CLEAR.</p>				
11694A				

	<table border="1" style="width: 100%; border-collapse: collapse;"> <tr> <td style="background-color: #cccccc; text-align: center; padding: 5px;"> WARNING </td> </tr> <tr> <td style="text-align: center; padding: 5px;"> <p>STAY CLEAR OF RAKE WHEN RAISING OR LOWERING RAKE WHEELS.</p> <p>FAILURE TO HEED THIS WARNING MAY RESULT IN PERSONAL INJURY OR DEATH.</p> </td> </tr> <tr> <td style="text-align: center; padding: 5px;"> <p>KEEP CLOTHING, YOURSELF AND OTHERS WELL CLEAR.</p> </td> </tr> </table>	WARNING	<p>STAY CLEAR OF RAKE WHEN RAISING OR LOWERING RAKE WHEELS.</p> <p>FAILURE TO HEED THIS WARNING MAY RESULT IN PERSONAL INJURY OR DEATH.</p>	<p>KEEP CLOTHING, YOURSELF AND OTHERS WELL CLEAR.</p>
WARNING				
<p>STAY CLEAR OF RAKE WHEN RAISING OR LOWERING RAKE WHEELS.</p> <p>FAILURE TO HEED THIS WARNING MAY RESULT IN PERSONAL INJURY OR DEATH.</p>				
<p>KEEP CLOTHING, YOURSELF AND OTHERS WELL CLEAR.</p>				
	2195			

	<table border="1" style="width: 100%; border-collapse: collapse;"> <tr> <td style="background-color: #cccccc; text-align: center; padding: 5px;"> WARNING </td> </tr> <tr> <td style="text-align: center; padding: 5px;"> <p>DO NOT GO NEAR LEAKS</p> <ul style="list-style-type: none"> • High pressure oil easily punctures skin causing serious injury, gangrene or death. • If injured, seek emergency medical help. Immediate surgery is required to remove oil. • Do not use finger or skin to check for leaks. • Lower load or relieve hydraulic pressure before loosening fittings. </td> </tr> </table>	WARNING	<p>DO NOT GO NEAR LEAKS</p> <ul style="list-style-type: none"> • High pressure oil easily punctures skin causing serious injury, gangrene or death. • If injured, seek emergency medical help. Immediate surgery is required to remove oil. • Do not use finger or skin to check for leaks. • Lower load or relieve hydraulic pressure before loosening fittings.
WARNING			
<p>DO NOT GO NEAR LEAKS</p> <ul style="list-style-type: none"> • High pressure oil easily punctures skin causing serious injury, gangrene or death. • If injured, seek emergency medical help. Immediate surgery is required to remove oil. • Do not use finger or skin to check for leaks. • Lower load or relieve hydraulic pressure before loosening fittings. 			
	11599		

TRACTOR:

This operators manual uses the term “Tractor” when identifying the power source.



WARNING

TO PREVENT SERIOUS INJURY OR DEATH

BEFORE YOU ATTEMPT TO OPERATE THIS EQUIPMENT, READ AND STUDY THE FOLLOWING INFORMATION. IN ADDITION, MAKE SURE THAT EVERY INDIVIDUAL WHO OPERATES OR WORKS WITH THIS EQUIPMENT, WHETHER FAMILY MEMBER OR EMPLOYEE, IS FAMILIAR WITH THESE SAFETY PRECAUTIONS.

DO NOT ALLOW PERSONNEL OTHER THAN THE QUALIFIED OPERATOR NEAR THE MACHINE.

Stop the tractor engine, remove ignition key, and allow all mechanisms to stop before cleaning, working, or adjusting on machine.

DO NOT attempt to perform maintenance or repair with tractor running.

DO NOT step up on machine at any time.

DO NOT allow minors to operate or be near the machine.

Loose or floppy clothing should not be worn by the operator.

Stay clear of hydraulic lines, they may be under extreme pressure or heat.

Stay clear of the rake when opening or closing main rake arm beams, opening the backbone or raising and lowering the rake wheels.

For transport, always make sure that the hair pin at the rear of the lift pipes, and the transport lock bars with safety clip pins for main rake beam, are securely locked in place.

To reduce stress on rake arms, lift pipe, springs and spring brackets, reduce the oil flow from the tractor to the lift cylinders whenever possible.

Be sure to raise the rake wheels before opening or closing the main rake beams.

H&S Manufacturing Co. always takes the operator and their safety into consideration and guards exposed moving parts for their protection. However, some areas cannot be guarded or shielded in order to assure proper operation. In addition, the operators manual and decals on the machine itself warn you of further danger and should be read and observed closely.

Study The Above Safety Rules
ATTENTION - BE ALERT - YOUR SAFETY IS INVOLVED

CAP SCREW TORQUE VALUES

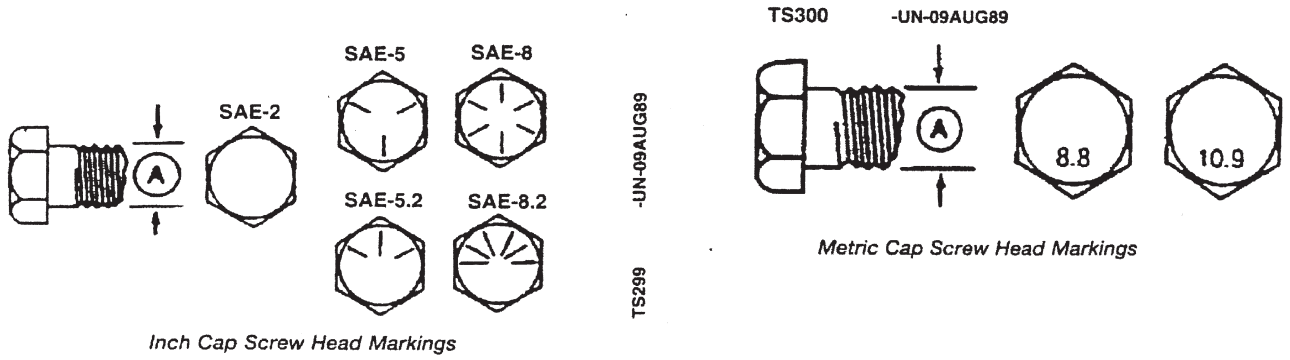

Inch Cap Screw Head Markings

Metric Cap Screw Head Markings

INCH CAP SCREW TORQUE VALUES

Bolt Diameter (A)	Wrench Size	Cap Screw Grade					
		SAE 2		SAE 5		SAE 8	
		N-m	lb.-ft	N-m	lb.-ft	N-m	lb.-ft
1/4"	7/16"	7	(5)	11	(8)	16	(12)
5/16"	1/2"	14	(10)	23	(17)	33	(24)
3/8"	9/16"	24	(18)	41	(30)	54	(40)
7/16"	5/8"	41	(30)	68	(50)	95	(70)
1/2"	3/4"	61	(45)	102	(75)	142	(105)
9/16"	13/16"	88	(65)	142	(105)	203	(150)
5/8"	15/16"	122	(90)	197	(145)	278	(205)
3/4"	1-1/8"	217	(160)	353	(260)	495	(365)
7/8"	1-5/16"	224	(165)	563	(415)	800	(590)
1"	1-1/2"	332	(245)	848	(625)	1193	(880)
1-1/4"	1-7/8"	665	(490)	1492	(1100)	2393	(1765)

METRIC CAP SCREW TORQUE VALUES

Bolt Diameter (A)	Wrench Size	Markings on Cap Screw Heads			
		8.8		10.9	
		N-m	lb.-ft	N-m	lb.-ft
5 mm	8 mm	6	(4.5)	9	(6.5)
6 mm	10 mm	10	(7.5)	15	(11)
8 mm	13 mm	25	(18)	35	(26)
10 mm	16 mm	50	(37)	75	(55)
12 mm	18 mm	85	(63)	130	(97)
16 mm	24 mm	215	(159)	315	(232)
20 mm	30 mm	435	(321)	620	(457)
24 mm	36 mm	750	(553)	1070	(789)
30 mm	46 mm	1495	(1103)	2130	(1571)



CAUTION: Use only metric tools on metric hardware. Other tools may not fit properly. They may slip and cause injury.

DO NOT use these values if a different torque value tightening procedure is listed for a specific application. Torque values listed are for general use only. Check tightness of cap screws periodically.

Shear bolts are designed to fail under predetermined loads. Always replace shear bolts with identical grade. Fasteners should be replaced with the same or higher grade. If higher grade fasteners are used, these should only be tightened to the strength of the original.

Make sure fastener threads are clean and you properly start thread engagement. This will prevent them from failing when tightening.

Tighten plastic insert or crimped steel-type lock nuts to approximately 50 percent of amount shown in chart. Tighten toothed or serrated-type lock nuts to full torque value.

SET-UP & ASSEMBLY

NOTE: Determine the right or left side of the wheel rake by viewing it from the rear. If instructions or parts lists call for hardened bolts, refer to the Cap Screw Torque Value Chart.

1. Assemble the rake or check the rake for proper assembly and adjustment. Make sure that all bolts are tightened.
2. Attach the wheels with tires, using the lug nuts furnished and torque the mounting hardware to 95 ft./lbs. of torque. Check wheel bolts periodically thereafter.
3. Check tires and inflate to the recommended pressure. (11L x 15 to 36 pounds)
4. Lubricate the rake completely (See Lubrication Chapter in This Manual).
5. Tooth bolts must be torqued to 40 ft./lbs. to help prevent excessive tooth breakage.
Re-torque rake tooth bolts after the first 100 acres. Check periodically thereafter.

TRANSPORTING

TRANSPORT LOCKS

Rake Beam Locks

Transport locks are mounted to the front of the pole. (A) Shows the rake locked into transport position. (B) Shows the transport locks in the convenient storage position, to be used when in the raking mode.

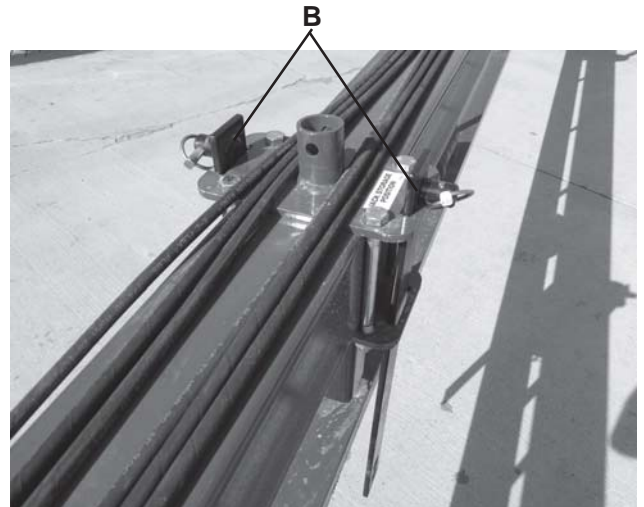
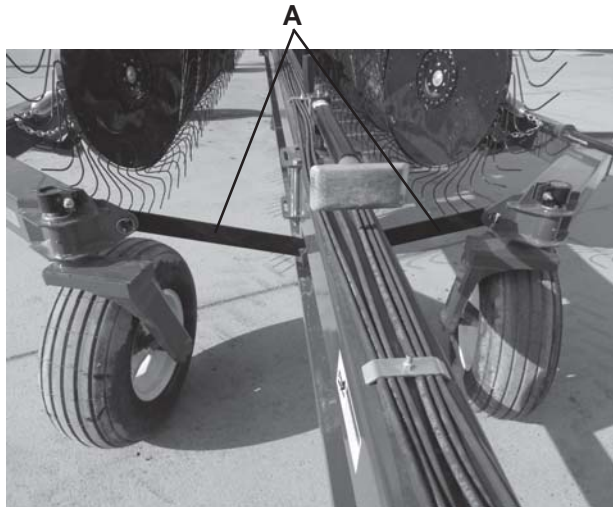

Rake Wheel Locks

Located on the lift pipe, is a hair pin which is used to secure the rake wheels in the up position for transport (C). When in the down, or raking position, place the locking hair pin in the convenient storage position (D).

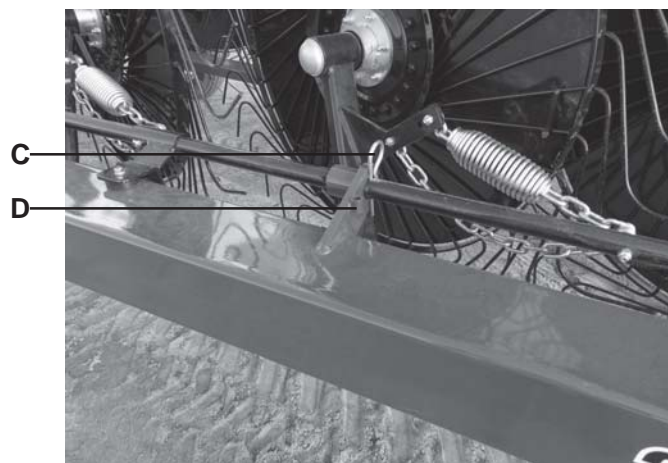

TOWING ON HIGHWAY

Follow state and local regulations when towing farm equipment on public highways. Never tow the rake on a public highway at a speed greater than 20 m.p.h. (32 kph).

REFLECTORS

Red and Amber reflective safety decals are on the rake for safety. Refer to the Decal Placement Chapter for location.

PREPARING FOR OPERATION

1. Adjust the tractor hitch (13 to 17 inches above ground) and attach the rake to the tractor with a **hitch pin and a safety locking device**.

2. There are twelve different positions to adjust the hitch on your Rake. The clevis hitch can be flipped for more settings.



3. Remove the weight from lift jack. Remove the jack from the pipe and place it on the convenient storage mount located on the front top of pole.



4. Connect the hydraulic hoses for raising and lowering the rake wheels to a double acting valve on the tractor.

5. Connect the hydraulic hoses for opening and closing the rake to a double acting valve on the tractor.

6. If the rake is equipped with the optional Hydraulic Rear Opening Width Cylinder, connect the hydraulic hoses to a double acting valve on the tractor.

7. Connect the 7-pin electrical connector to tractor if the rake is equipped with optional lighting.

OPERATION & ADJUSTMENTS

EMERGENCY SHUTDOWN

Stop the tractor engine, remove ignition key, and allow all mechanisms to stop before cleaning or working on the machine.

RAKING WIDTH

Raking width is determined by setting the spring loaded stop, located above the rear pole section as shown.

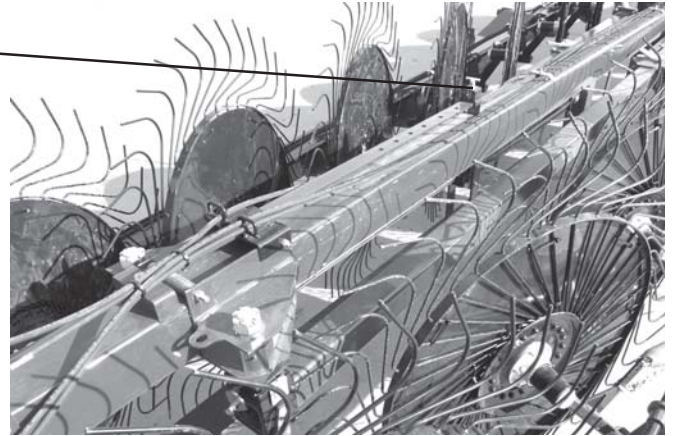

WINDROW WIDTH

Windrow width adjustment is made by the ratchet jack located on the right rear of the rake as shown.

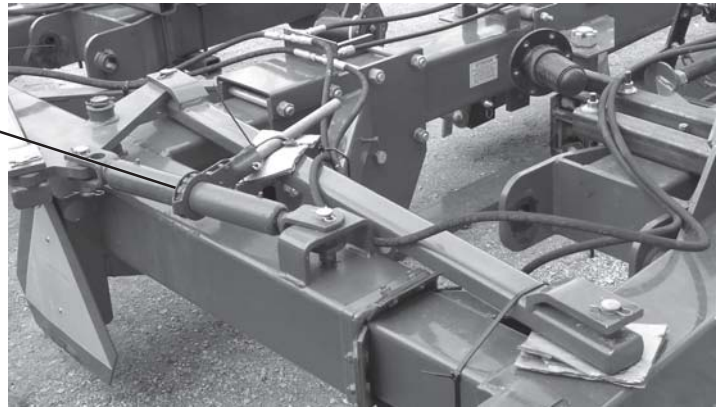

OPERATION & ADJUSTMENTS

GROUND PRESSURE

Rake wheel to ground pressure is adjusted by turning the tab nut on the threaded rod while the rake wheels are in the raised position. The further forward that the nut is on the threaded rod, the lesser the amount of rake wheel ground pressure. The further back that the nut is on the threaded rod, the greater the amount of rake wheel ground pressure.



GAUGE WHEELS

Outboard gauge wheels are located on the forward section of each rake beam. These gauge wheels support the rake beams to allow the rake wheels to better follow the contour of the ground. Located on each gauge wheel pivot spindle is an adjustable brake assembly. Adjust the brake by tightening bolt and nut. The brake should have enough tension to prevent zig-zag motion, but still allow the wheel to pivot when making corners.



Adjustable
Brake
Assembly

OPTIONAL EQUIPMENT

HYDRAULIC OPENING WINDROW WIDTH ADJUSTMENT

Hydraulic Opening Windrow Width Adjustment is optional in place of the standard ratchet jack. This option requires a 3rd tractor remote.

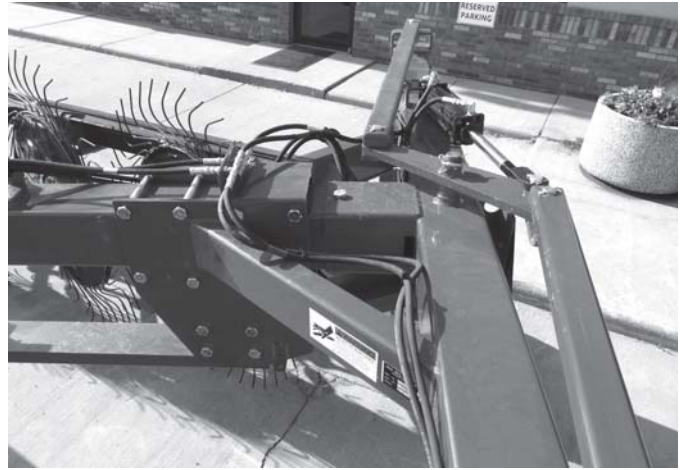

REAR TANDEM AXLE

Tandem walking beam axles are optional on all models of Flex-Frame Rakes. A single axle is standard.



LIGHTING PACKAGE

A Lighting Package that includes tail lights and work lights is optional.

3-WHEEL CENTER KICKER

A 3-Wheel Center Kicker Assembly disturbs and moves the un-raked crop in the center.

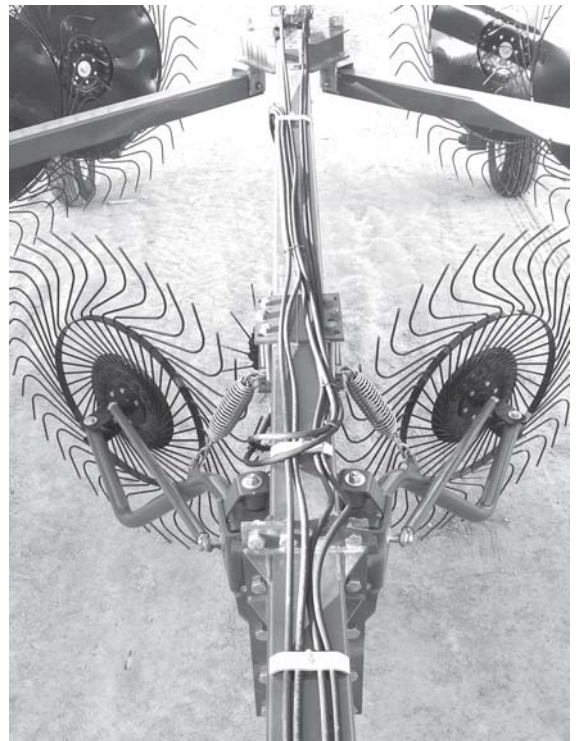

LUBRICATION GUIDE

GREASE FITTINGS

There are numerous grease fittings on the Flex-Frame Rake. If lubricated properly and often enough, it will prolong the life of your Rake. Grease daily during normal use and **before and after storage and after power washing**. Use a good grade of high quality grease. Make sure that grease comes out around the shaft on sleeve type bearings. Wipe off excessive grease to prevent accumulation of chaff or grit around the bearing.

LOCATION

Listed and shown are the description of location and number of grease fittings.

- A. (4) One on each Gauge Wheel
- B. (6 or 8) One on each Transport Wheel Hub - (Single/Tandem)
- C. (2) One on each Rake Arm Swing Pivot
- D. (2) One on each Rake Arm Raise/Lower Rear Flex Pivot
- E. (2) One on each Middle Flex Arm Pivot
- F. (1) One on the Windrow Width Adjustment Cylinder/Jack Pivot
- G. (6) Three on each Rear Rake Arm Linkage Pivot Assembly



A.
One on each
Gauge
Wheel

B.
One on each Transport
Wheel Hub

Shown w/optional tandem axles



D.
One on each
Rake Arm
Raise/Lower
Rear Flex Pivot

C.
One on each
Rake Arm
Swing Pivot

LUBRICATION GUIDE

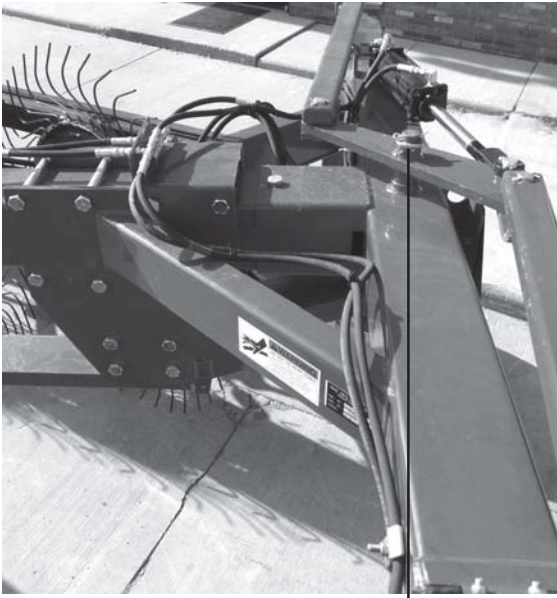

F.
One on the Windrow Width
Adjustment Cylinder/Jack Pivot

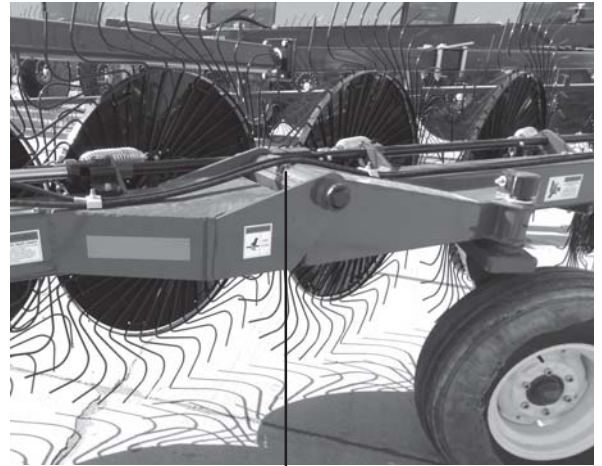

E.
One on each Middle
Flex Arm Pivot



G.
Three on each Right & Left
Rear Rake Arm Linkage
Pivot Assembly

DECAL LOCATION

Your Rake was manufactured with operator safety in mind. Located on the Flex-Frame Rake are various decals to aid in operation, and warn of danger or caution areas. Pay close attention to all the decals.



DO NOT REMOVE ANY OF THESE DECALS. IF DECALS ARE LOST, DAMAGED, OR IF THE FLEX-FRAME RAKE IS REPAINTED, REPLACE DECALS. REMEMBER: DECALS ARE FOR YOUR PROTECTION AND INFORMATION.

Listed below are the decals on your H&S Flex-Frame Rake. These decals may be ordered individually by part number or by ordering complete set.

<u>PART</u>	<u>QUANTITY</u>	<u>DESCRIPTION</u>
311	1	Patent Numbers
1906C	2	Stay Clear
2195	11	WARNING - Stay Clear of Rake
21804	1	Attention - Never Adjust Main Frame
60354	1	H&S Flex-Frame Rake RH
60355	1	H&S Flex-Frame Rake LH
60356	2	Model Number-6118
60357	2	Model Number-6120
60358	2	Model Number-6122
60854	1	H&S Flex-Frame Rake Rear
11599	7	WARNING - Do Not Go Near Leaks
11694A	8	DANGER - Stay Clear of Rake
12197A	1	Attention: Raise Rake Wheels
54034	1	Made in the USA - 4"
71188B	1	Jack Storage Position
72203A	1	WARNING - Help Avoid Injury
BFR723	1	SMV Sign Kit
DCAMB	10	Amber Reflector - 2" x 9"
DCRED	2	Red Reflectors
093020	17	Grease Zerk

DECAL LOCATION

Hitch/Jack

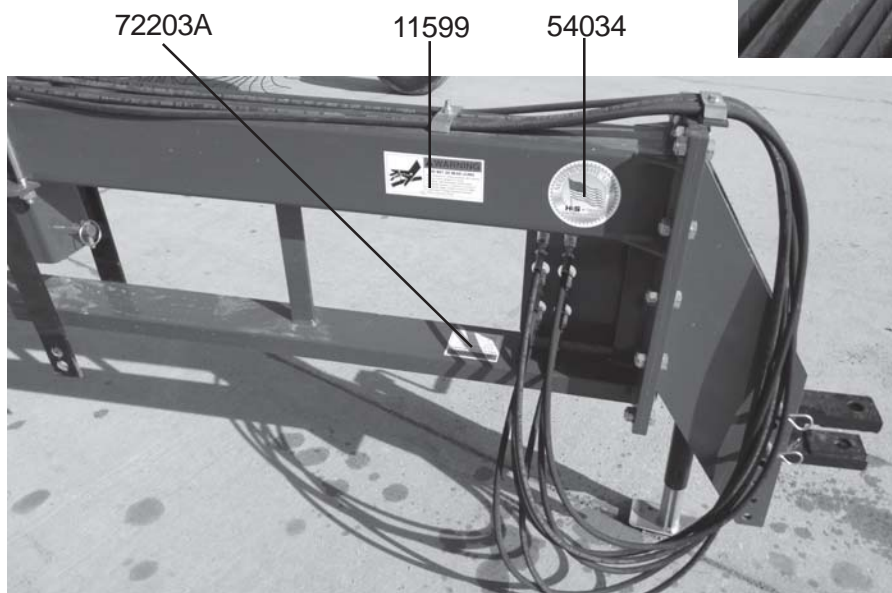
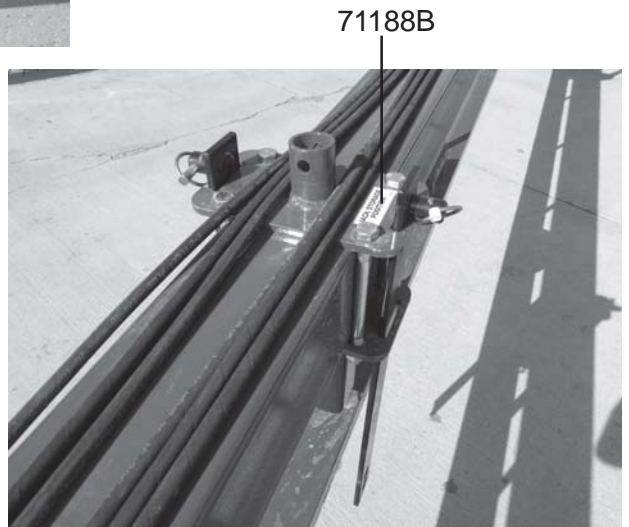
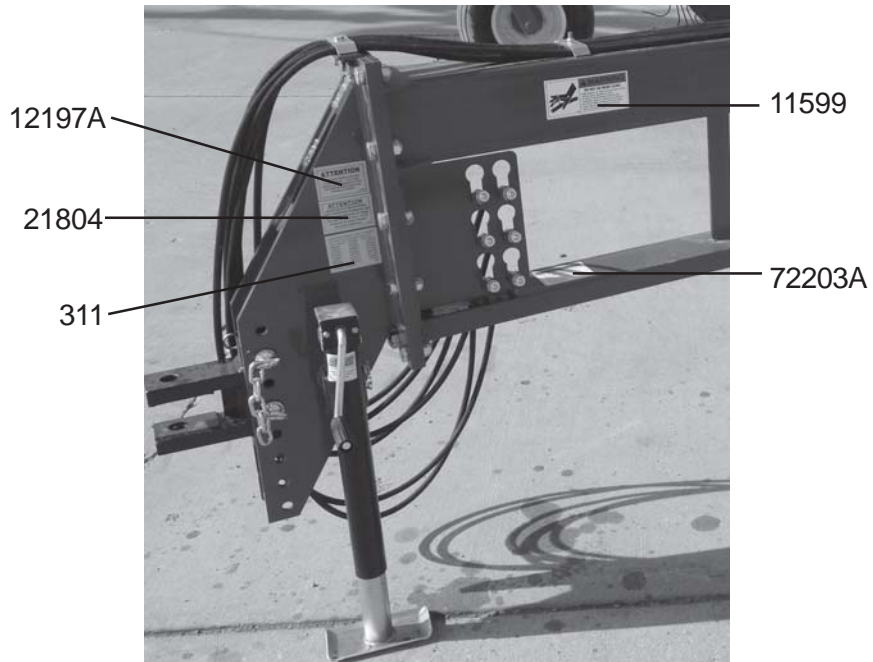

DECAL LOCATION

Left Rake Beam

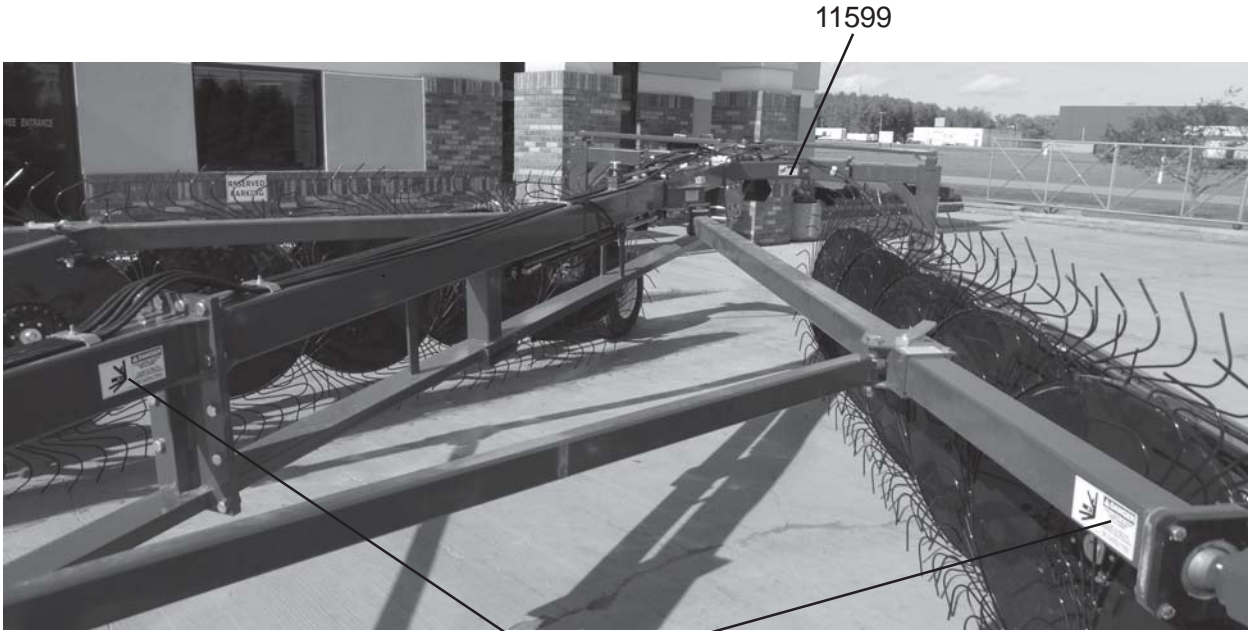

11694A

Right Rake Beam



11694A

DECAL LOCATION

Left Rake Beam

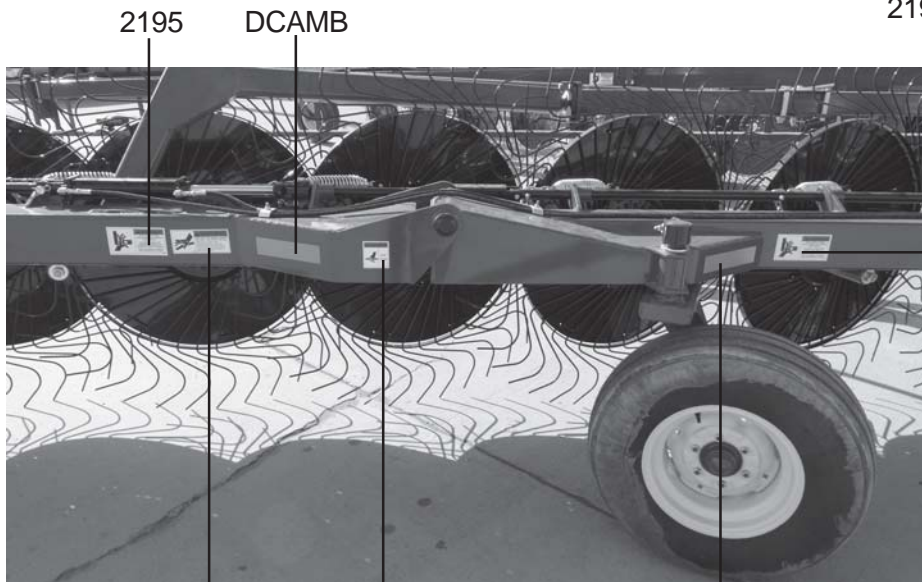
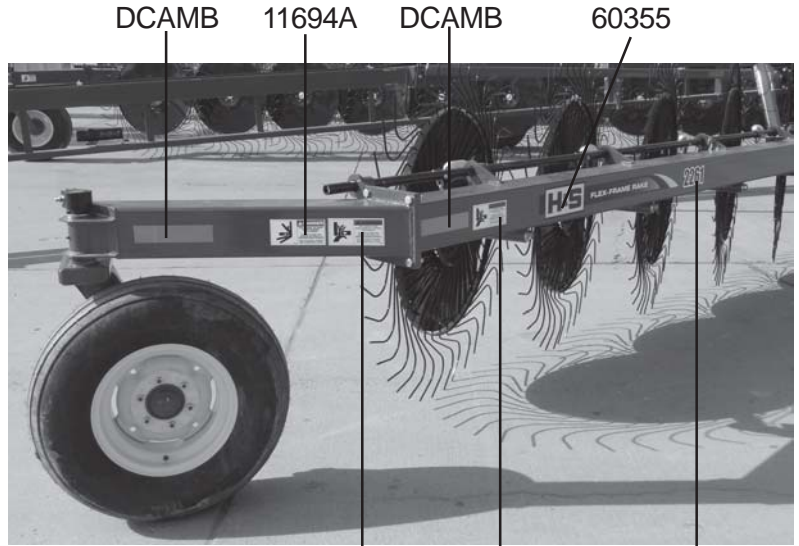
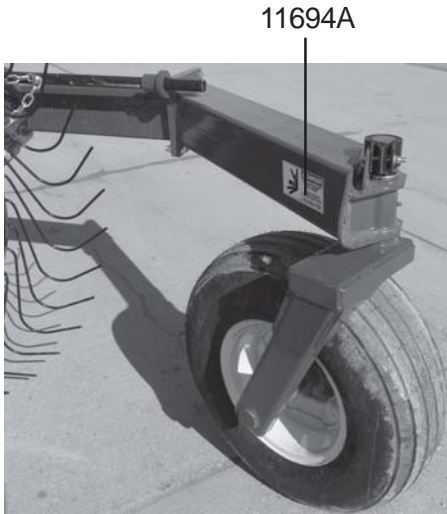

2195 2195 Model #
 6118 - 60356
 6120 - 60357
 6122 - 60358



Shown w/optional tandem axles

DECAL LOCATION

Right Rake Beam

Model #
6118 - 60356
6120 - 60357
6122 - 60358

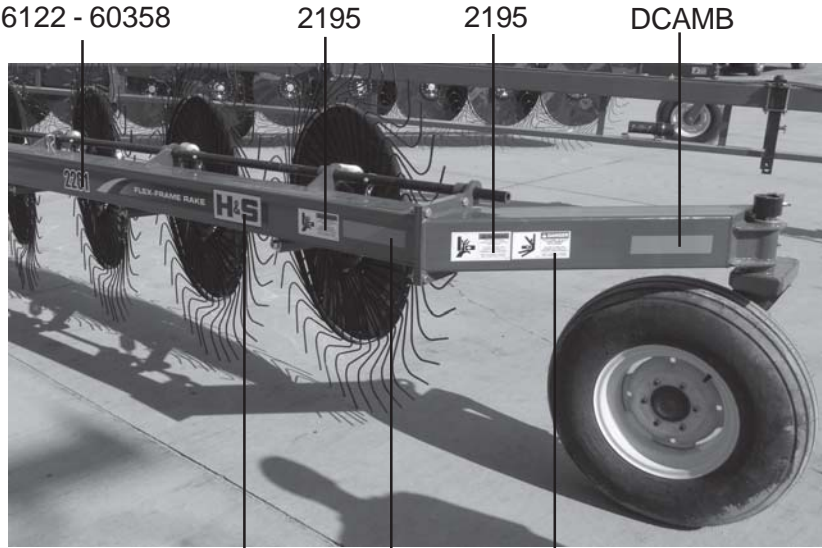

60354 DCAMB 11694A

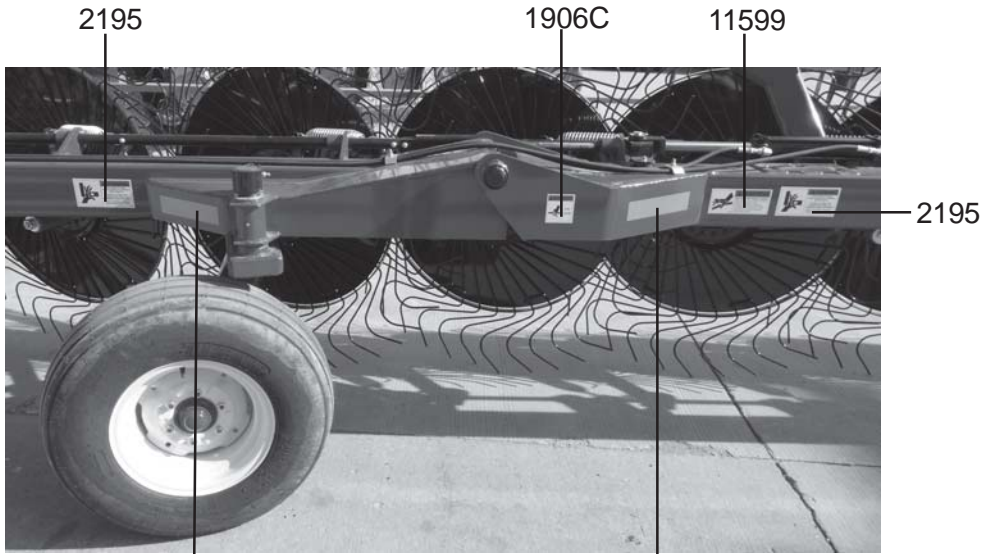

DCAMB

DCAMB



Shown w/optional
tandem axles

DECAL LOCATION

Rear

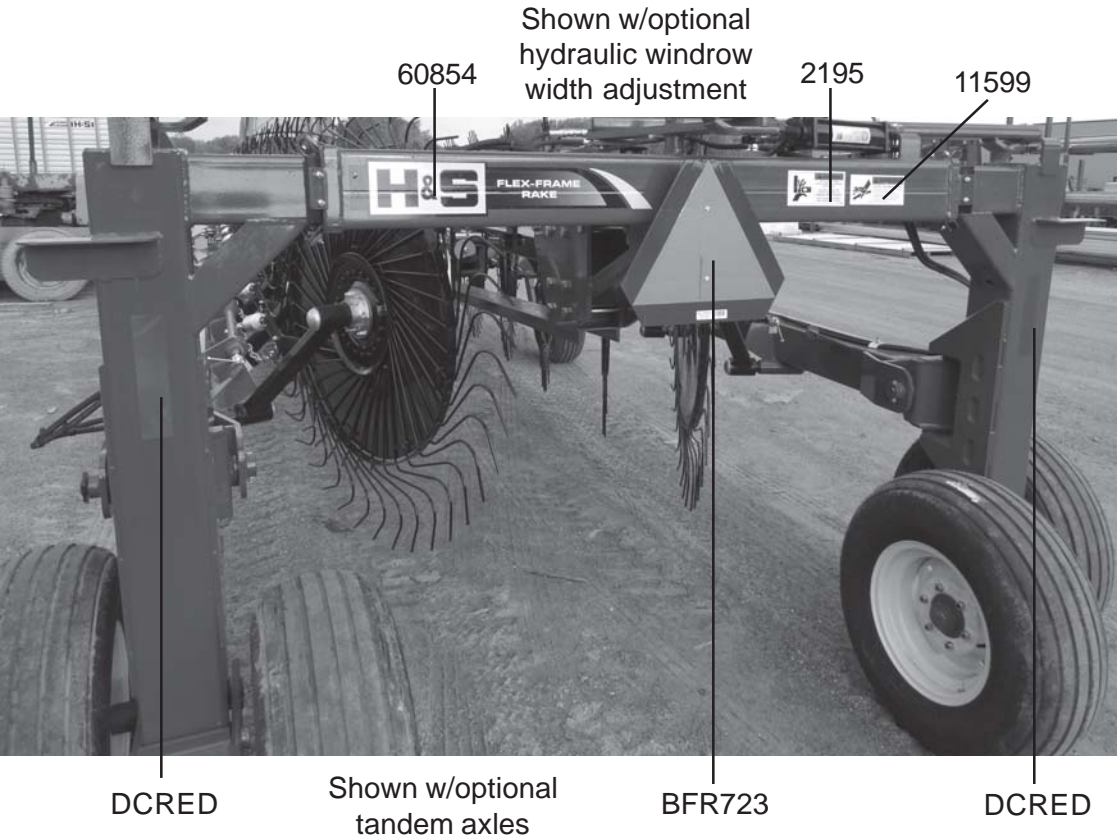

TROUBLE SHOOTING



WARNING:

MAKE SURE THAT THE TRACTOR IS SHUT OFF AND THE RAKE CAN NOT MOVE BEFORE SERVICING THE FLEX-FRAME RAKE. MAINTENANCE AND REPAIR SERVICE WORK TO BE PERFORMED BY A QUALIFIED SERVICE PERSON ONLY.

TROUBLE

POSSIBLE CAUSE

POSSIBLE REMEDY

Rake Will Not Open

Rake Locked In Transport

Remove Transport Locks And Return To Storage Position

Hydraulic Couplers Not Coupled To Tractor Properly

Couple Hydraulic Hoses To Tractor

Hydraulic Hoses Mixed Up With Rake Wheel Lift Hose

Sort Hoses Correctly And Re-couple To Tractor

Tractor Hydraulics Do Not Have Sufficient Pressure

Tractor Should Have At Least 1500 PSI To Operate Rake
NOTE: Always Drive Forward Slowly And Open Rake At The Same Time

Rake Will Not Close

Tractor Hydraulics Do Not Have Sufficient Pressure

Tractor Should Have At Least 1500 PSI To Operate Rake
NOTE: Always Drive Forward Slowly And Open Rake At The Same Time

Rake Wheels Will Not Lower

Rake Wheels Locked In Transport

Remove Hair Pin From Adjuster, Place In Storage Position

Lift Pipe Binding

Check Lift Pipe Make Sure It Is Free Moving

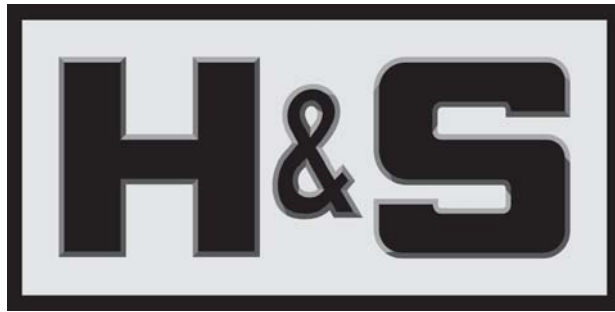

**H&S Manufacturing products are approved for the
FEMA SEAL OF QUALITY**

**P.O. BOX 768, MARSHFIELD, WI 54449
(715) 387-3414 FAX (715) 384-5463
www.hsmfgco.com**