

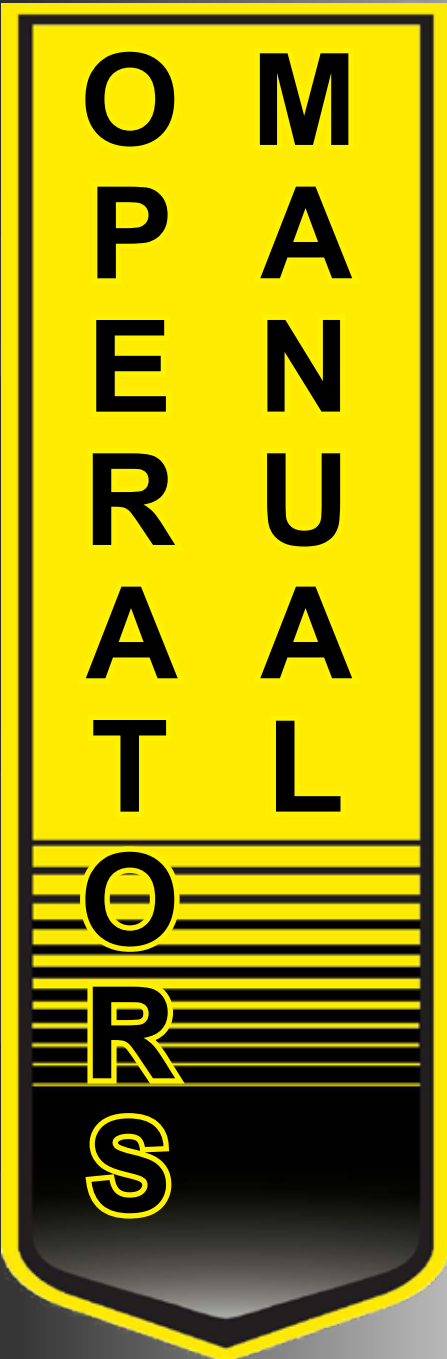

9117 GRINDER MIXER



WARNING

READ AND UNDERSTAND THIS MANUAL BEFORE OPERATING THIS EQUIPMENT. UNSAFE OPERATION OR MAINTENANCE OF THIS EQUIPMENT CAN RESULT IN SERIOUS INJURY OR DEATH.

Starting Serial #221GX17001

Part #94347

Rev. #01

HSMFG110221

STRONG HERITAGE - STRONG PEOPLE - STRONGER FUTURE

CONTENTS

Warranty	1
Manufacturer's Statement	2
Warranty Registration Form	3
Dealer Pre-Delivery Checklist	5
Dealer Delivery Checklist	7
Safety Information - Be Alert Symbol	9
Safety Information - Explanation of Safety Signs	10
Safety Decals	11-12
Safety Information - Warning - Owner Must Read and Understand	13-14
Cap Screw Torque Values	15
Hydraulic Fitting Torque Specifications	16-17
Set-Up & Assembly	18
Transporting	19
Preparing for Operation	20
Operation	21-27
Adjustments	28-31
Service	32-35
Optional Equipment	36
Lubrication Guide	37-38
Decal Location	39-45
Troubleshooting	46-50
Service Notes	51-52

H&S WARRANTY

H&S Manufacturing Co., Inc. ("H&S") warrants this product to be free from defect in material and workmanship. Except as noted below, this warranty term is twelve (12) months on labor, and twenty-four (24) months on parts from the date of delivery of the product to the original purchaser by an authorized H&S dealer. Under this warranty, H&S will repair or replace, at its option, any covered part which is found to be defective in material or workmanship during the applicable warranty term. In no case will the covered repair cost of a part or parts exceed the replacement cost of that part. Warranty service must be performed by H&S or a dealer authorized by H&S to sell and/or service the product involved, which will use only new or remanufactured parts or components furnished by H&S. This warranty includes approved parts and labor to fix the product but does not include, and the purchaser is responsible for, any service call and/or transportation of the product to and from the dealer's place of business, for any premium charged for overtime labor requested by the purchaser, and for any service work not directly related to any defect covered under this warranty. This warranty includes only those components of the product manufactured by H&S. Warranty for any component not manufactured by H&S including, but not limited to, engines, batteries, tires, rims, hydraulic motors, pumps, etc. are covered by the warranty, if any, provided separately by their respective manufacturers.

This warranty in all its parts, is extended solely to the original purchaser of the product, is terminated upon any subsequent transfer or sale from or by the original purchaser and extends no third party benefits or rights whatsoever.

The warranty term for any product used in any commercial, custom, for hire or rental application, is limited to six (6) months from the date of delivery of the product to the original purchaser or the first day of service, whichever comes first, by an authorized H&S dealer.

For commercial, custom for hire, or rental application, warranty is limited to 6 months from the date of delivery to the original purchaser, or the first day in service, whichever is earlier.

This warranty does not include: (1) Any product that has been altered or modified in ways not approved by H&S; (2) Depreciation or damage caused by normal wear, use for which the product was not designed, misuse, improper or insufficient maintenance, improper operation, accident or failure to follow the product Operator's Manual recommendations and product decal recommendations; (3) Normal maintenance parts and service; (4) Repairs made with parts other than those available from H&S or performed by anyone other than H&S or a dealer authorized by H&S to sell and/or service the product involved.

To secure warranty service the purchaser must report the product defect to a dealer authorized by H&S to sell and/or service the product involved within the applicable warranty term together with evidence of the warranty start date and make the product available to that dealer within a reasonable period of time.

THERE ARE NO WARRANTIES WHICH EXTEND BEYOND THE DESCRIPTION ON THE FACE OF THIS WARRANTY. H&S and the companies affiliated with it makes no warranties, representations, or promises, express or implied, as to the performance or freedom from defect of its products other than those set forth above and **NO IMPLIED WARRANTY OF MERCHANTABILITY, FITNESS OR FITNESS FOR A PARTICULAR PURPOSE IS MADE. IN NO EVENT WILL THE DEALER, H&S OR ANY COMPANY AFFILIATED WITH H&S BE LIABLE FOR INCIDENTAL OR CONSEQUENTIAL DAMAGES.** The **ONLY REMEDY** the purchaser has in connection with the breach of performance of any warranty on H&S products are those set forth above.

The selling dealer has no authority to make any representation or promise on behalf of H&S, or to modify the terms or limitations of this warranty in any way.

11/14/18

MANUFACTURER'S STATEMENT

Your New H&S Product has been manufactured of the finest quality materials and components. The performance you get from your machine is largely dependent upon how well you read and understand this manual and apply this knowledge. There is a right and a wrong way to do everything. Please do not assume that you know how to operate and maintain your Machine before reading this manual carefully. Keep this manual available for ready reference.

H&S reserves the right to make changes or add improvements to its products at any time without incurring any obligation to make such changes to products previously manufactured. Specifications, statements and descriptions of Products contained in this publication are subject to change without prior notification.

WARRANTY REGISTRATION

- ❖ Date of Purchase: _____
 - ❖ Purchaser Name: _____
 - ❖ Street Address: _____
 - ❖ City: _____
 - ❖ State: _____ Zip: _____
 - ❖ Phone Number: _____
 - E-mail Address: _____
 - ❖ Product: _____
 - ❖ Model Number: _____
 - ❖ Serial Number: _____
 - ❖ You have received the Operators Manual for this product. Yes _____ No _____
- Interested in receiving the H&S Newsletter? Yes _____ No _____
-

- ❖ Dealer Name: _____
- ❖ Street Address: _____
- ❖ City: _____
- ❖ State: _____ Zip: _____
- ❖ Signature: _____

❖ *All fields must be filled out to insure prompt notification of product and/or warranty updates.*

Please mail the completed WARRANTY REGISTRATION FORM to:
H&S Manufacturing Co., Inc.
2608 S. Hume Ave.
Marshfield, WI 54449

(Remove Copy At Perforation)

Intentionally Left Blank

DEALER PRE-DELIVERY CHECK LIST

AFTER COMPLETION, DEALER SHOULD REMOVE AND RETAIN FOR RECORDS

After the Roller Mixer has been completely set-up, check to be certain it is in correct operating order before delivering to the customer. The following is a list of points to inspect. Check off each item as you have made the proper adjustments and found the item operating satisfactorily.

- Mixer was not damaged in shipment. Check for dents and loose or missing parts. Report damage immediately to H&S Manufacturing Co., Inc.
- All bolts and fasteners are tight.
- Mixer has been correctly assembled according to instructions in this manual. Wheels are properly mounted and wheel nuts are torqued to specs.
- Check all bearing locking collars to ensure they are tight on the shafts and in good condition.
- Check that all set screws on the bearing collars are tight.
- Check that all bearing mounting hardware is secure.
- All grease fittings have been lubricated. The transmission and cyclonic reservoir are filled to proper levels. See Lubrication Chapter of this manual for details.
- No visible leaks on the hydraulic pump, motors, hoses and fittings.
- Guards and shields are secure.
- Tires are inflated to 80 PSI (563 kpa).
- Belts are properly adjusted.
- Discharge auger door operates smoothly.
- Decals are in place and legible.
- Lights and wiring functioning properly if applicable.

INTAKE AUGER (If applicable)

- Guards, shields, and attaching hardware are in place and properly secured.
- Intake Auger supporting mechanisms function correctly.
- Safety locking clip is in place & locked.
- Hydraulic motor and speed control levers operate properly during operation.
- Decals are in place and legible.

Connect the Mixer onto a proper horsepower 540 RPM or 1000 RPM (if applicable) tractor and attach the PTO. Connect the scale and lights if applicable. Run the Mixer and make sure all components operate properly.

- PTO guard turns freely.
- Hydraulic system does not leak under pressure.
- Electronic Scale (if provided) operates properly.
- Implement and all components are functioning properly.

Model Number _____ Serial Number _____

Dealer's Name _____

Inspection Date _____

Signature of Pre-Delivery Inspector _____

(Remove Dealer File Copy At Perforation)

Intentionally Left Blank

DEALER DELIVERY CHECK LIST

AFTER COMPLETION, DEALER SHOULD REMOVE AND RETAIN FOR RECORDS

This check list that follows is an important reminder of valuable information that should be passed on to the customer at the time this is delivered.

Check off each item as you explain it to the customer.

This delivery check list, when properly filled out and signed assures the customer that the Pre-delivery service was satisfactorily performed.

- Explain to the customer that the pre-delivery inspection was made.
- Explain to the customer all the safety precautions they must take when operating this unit.
- Explain to customer that regular lubrication is required for proper operation and long life of machine.
- Show customer the lubrication section of Owner's Manual.
- Give the customer Owner's Manual and make sure they read and understand all operating and service instructions.
- Have the customer sign a completed "Warranty Registration", and mail it.

Date Delivered _____

Dealer's Name _____

By _____

Signature of Original Buyer _____

(Remove Dealer File Copy At Perforation)

Intentionally Left Blank

SAFETY INFORMATION



**BE
ALERT!**

**YOUR SAFETY
IS INVOLVED.**

THIS SYMBOL IS USED THROUGHOUT THIS BOOK WHENEVER YOUR PERSONAL SAFETY IS INVOLVED. TAKE TIME TO BE CAREFUL. REMEMBER: THE CAREFUL OPERATOR IS THE BEST OPERATOR. MOST ACCIDENTS ARE CAUSED BY HUMAN ERROR. CERTAIN PRECAUTIONS MUST BE OBSERVED TO PREVENT THE POSSIBILITY OF INJURY OR DAMAGE.

H&S MANUFACTURING CO., INC.

SAFETY INFORMATION

Keep signs in good condition. Immediately replace any missing or damaged signs.

RECOGNIZE SAFETY INFORMATION

This is the safety-alert symbol. When you see this symbol on your machine or in this manual, be alert to the potential for personal injury.

Follow recommended precautions and safe operating practices.



UNDERSTAND SIGNAL WORDS

A single word; DANGER, WARNING, or CAUTION - is used with the safety-alert symbol. DANGER identifies the most serious hazards.

Safety signs with signal word DANGER or WARNING are typically near specific hazards.

General precautions are listed on CAUTION safety signs.



WARNING



CAUTION



FOLLOW SAFETY INSTRUCTIONS

Carefully read all safety messages in this manual, and all safety signs on your machine. Follow all recommended precautions and safe operating procedures.

OBSERVE MAXIMUM TRANSPORT SPEED

The maximum transport speed for this implement is 32 km/h (20 m.p.h.).

Some tractors are capable of operating at speeds that exceed the maximum transport speed of this implement. Regardless of the maximum speed capability of the tractor being used to tow this implement, do not exceed the implement's maximum transport speed.

Exceeding the implements maximum transport speed can result in:

- * Loss of control of the tractor/implement combination
- * Reduced or no ability to stop during braking
- * Implement tire failure
- * Damage to the implement structure or its components

Use additional caution and reduce speed when towing under adverse surface conditions, when turning, and when on inclines.

Do not attempt transport if the fully loaded implement weighs more than 1.5 times the weight of the tractor.



SAFETY INFORMATION

Your Mixer was manufactured with operator safety in mind. Located on the Mixer are various decals to aid in operation, and to warn of danger or caution areas. Pay close attention to all the decals on your Mixer.



DO NOT REMOVE ANY OF THESE DECALS. IF DECALS ARE LOST, DAMAGED, OR IF YOUR MIXER IS REPAINTED, REPLACE DECALS. REMEMBER: DECALS ARE FOR YOUR PROTECTION AND SAFETY.

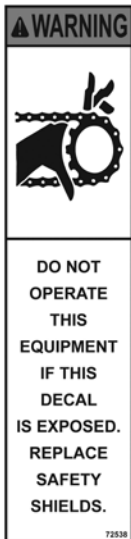

SAFETY INFORMATION



⚠ WARNING

**STAY CLEAR
KEEP HANDS OUT
OF SUPPLEMENT
HOPPER**

82907G



⚠ WARNING

DO NOT GO NEAR LEAKS

- High pressure oil easily punctures skin causing serious injury, gangrene or death.
- If injured, seek emergency medical help. Immediate surgery is required to remove oil.
- Do not use finger or skin to check for leaks.
- Lower load or relieve hydraulic pressure before loosening fittings.

11599



⚠ DANGER

KEEP OUT

DO NOT ENTER TANK.
KEEP COVER CLOSED.

FAILURE TO HEED THIS WARNING MAY RESULT IN PERSONAL INJURY OR DEATH.

82907F



⚠ WARNING

**STAY CLEAR
OF DISCHARGE
AUGER**

82907A

⚠ WARNING



**KEEP CHILDREN AWAY
AT ALL TIMES!**

2495

⚠ WARNING



CRUSHING HAZARD

TO PREVENT SERIOUS INJURY OR DEATH:

KEEP HANDS AND BODY OUT OF HITCH AREA WHEN ATTACHING TOWING VEHICLE.

KEEP BODY CLEAR OF CRUSH POINT BETWEEN TOWING VEHICLE AND LOAD.

KEEP FEET AND LEGS CLEAR FROM UNDER TONGUE AREA IN CASE OF POSSIBLE JACK FAILURE.

82602

⚠ WARNING

**DO NOT OPERATE
THIS EQUIPMENT
IF THIS DECAL IS
EXPOSED.
REPLACE SAFETY
SHEILDS.**

32597A

⚠ DANGER



NO STEP-STAY CLEAR

9194A

⚠ WARNING

HELP AVOID INJURY

- READ & UNDERSTAND THE OPERATORS MANUAL PROVIDED WITH THIS MACHINE. IF MISPLACED CALL H & S MANUFACTURING AT 715-387-3414 WITH MODEL AND SERIAL NUMBER.
- UNDERSTAND ALL SAFETY WARNINGS AND FUNCTION OF CONTROLS.
- KEEP SAFETY DEVICES IN PLACE AND WORKING.
- KEEP YOURSELF AND OTHERS WELL CLEAR OF MOVING PARTS.
- DISCONNECT ALL POWER BEFORE SERVICING OR CLEANING THIS MACHINE.
- DO NOT EXCEED 20 MPH

72203A

SAFETY INFORMATION

 <small>82907B</small>	⚠ WARNING
	STAY CLEAR OF AUGER EXTENSION HINGE AREA

 <small>82907C</small>	⚠ DANGER
	STAY CLEAR KEEP HANDS AND FEET AWAY FROM AUGER AT ALL TIMES FAILURE TO HEED THIS WARNING MAY RESULT IN <u>PERSONAL INJURY OR DEATH</u>

 <small>82907D</small>	⚠ WARNING
	STAY CLEAR ROTATING PARTS INSIDE

 <small>81209</small>	⚠ WARNING
	AVOID SERIOUS INJURY FROM CUTTING BY OR ENTANGLEMENT WITH ROTATING AUGER. NEVER REMOVE PANEL WITH MACHINE RUNNING.

⚠ DANGER

NEVER ALLOW RIDERS ON THIS MACHINE
<small>82907L</small>

TRACTOR:

This operators manual uses the term “Tractor” when identifying the the power source.



WARNING

TO PREVENT SERIOUS INJURY OR DEATH

BEFORE YOU ATTEMPT TO OPERATE THIS EQUIPMENT, READ AND STUDY THE FOLLOWING INFORMATION. IN ADDITION, MAKE SURE THAT EVERY INDIVIDUAL WHO OPERATES OR WORKS WITH THIS EQUIPMENT, WHETHER FAMILY MEMBER OR EMPLOYEE, IS FAMILIAR WITH THESE SAFETY PRECAUTIONS.

DO NOT ALLOW PERSONNEL OTHER THAN THE QUALIFIED OPERATOR NEAR THE MACHINE.

KNOW HOW TO STOP MACHINE BEFORE STARTING IT.

If the machine becomes clogged or for servicing, Stop the tractor engine, remove ignition key and allow all mechanisms to stop. Before cleaning or working on the machine, detach the PTO shaft, and completely disengage the tractor hydraulics.

DO NOT attempt to perform maintenance or repair with tractor running, PTO and hydraulic hoses connected to the tractor.

NEVER ALLOW RIDERS IN OR ON THE MACHINE.

DO NOT step up on machine at any time while in operation.

DO NOT allow minors to operate or be near the machine.

STAY CLEAR of discharge auger when in operation.

Keep hands, feet, and clothing away from all moving parts when the Mixer is in operation.

Loose or floppy clothing should not be worn by the operator.

Be sure the machine is clear of people, tools, and other objects before engaging PTO.

Do not step over PTO shaft: Stay clear of PTO at all times.

NEVER start the Mixer until all guards and safety shields are secured in place.

Never operate Mixer with a PTO speed greater than the recommended PTO RPM.

STAY CLEAR of hydraulic lines, they may be under extreme pressure or heat.

NEVER open or plug the water drain holes with the Mixer running.

H&S Mfg. Co. always takes the operator and their safety into consideration and guards exposed moving parts for their protection. However, some areas cannot be guarded or shielded in order to assure proper operation. In addition, the operators manual and decals on the machine itself warn you of further danger and should be read and observed closely.

Study The Above Safety Rules
ATTENTION - BE ALERT - YOUR SAFETY IS INVOLVED

CAP SCREW TORQUE VALUES

The specifications below are the torque values for fasteners as it adheres to the SAE torque value standards. All fasteners should be torqued to the proper values found in the figures below unless otherwise specified by the engineering drawing.

Lubed torque would be any fastener that has grease, liquid Loctite, oil, etc. on the threads.

Dry torque would be any fastener which has threads that are clean and dry and do not have any liquid Loctite or grease on them.

Hex Head Fasteners

The figure shown below shows how to determine what grade a fastener is.

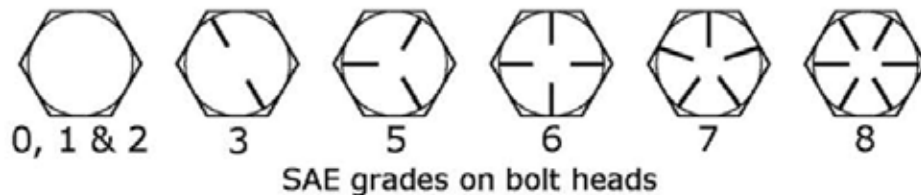

SUGGESTED ASSEMBLY TORQUE VALUES							WORKING TORQUE			
Diam & Thrds Per Inch	SAE GRADE 2 -6"		SAE GRADE 5		SAE GRADE 8		18-8 SS	316 SS	BRASS	SILICON BRONZE
	Dry FT. LB.	LUB FT. LB.	Dry FT. LB.	LUB FT. LB.	Dry FT.LB.	LUB FT. LB.	IN LBS	IN LBS	IN LBS	IN LBS
1/4-20	5.5	4.2	8	6.3	12	9	75.2	78.8	61.5	68.6
1/4-28	6.3	4.7	10	7.2	14	10	94.0	99.0	77.0	87.0
5/16-18	11	8	17	13	24	18	132	138	107	123
5/16-24	12	9	19	14	27	20	142	147	116	131
3/8-16	20	15	30	23	45	35	236	247	192	219
3/8-24	23	17	35	25	50	35	259	271	212	240
7/16-14	32	24	50	35	70	50	376	393	317	349
7/16-20	36	27	55	40	80	60	400	418	327	371
1/2-13	50	35	75	55	110	80	517	542	422	480
1/2-20	55	40	85	65	120	90	541	565	443	502
9/16-12	70	55	110	80	150	110	682	713	558	632
9/16-18	80	60	120	90	170	130	752	787	615	697
5/8-11	100	75	150	110	210	160	1110	1160	907	1030
5/8-18	110	85	170	130	240	180	1244	1301	1016	1154
3/4-10	175	130	260	200	380	280	1530	1582	1249	1416
3/4-16	200	140	300	220	420	310	1490	1558	1220	1382
7/8-9	170	125	430	320	600	450	2328	2430	1905	2140
7/8-14	180	140	470	350	670	500	2318	2420	1895	2130
1-8	250	190	640	480	910	680	3440	3595	2815	3185
1-14	280	210	720	540	1020	760	3110	3250	2545	2885

HYDRAULIC FITTING TORQUE SPECIFICATIONS

Tapered Pipe Thread Size - Assembly turns from Finger Tight (TFFT) for Tapered Threads		TFFT
BSPT (Uncommon)	NPTF (Common)	
1/8-28	1/8-27	2 - 3
1/4-19	1/4-18	2 - 3
3/8-19	3/8-18	2 - 3
1/2-14	1/2-14	2 - 3
3/4-14	3/4-14	2 - 3
1-11	1-11 1/2	1.5 - 2.5
1 1/4-11	1 1/4-11 1/2	1.5 - 2.5
1 1/2-11	1 1/2-11 1/2	1.5 - 2.5
2-11	2-11 1/2	1.5 - 2.5



ORB - SAE J1926 Straight Thread Port Assembly Torques													
		Assembly Torque (+10% -0) **If fitting is being torqued into aluminum or brass, subtract 35% from standard torque value**											
		Non-Adjustable				Adjustable				Plugs			
		ORFS		JIC NPT		ORFS		JIC		Hollow Hex		Hex Head	
Dash Size	SAE Size (UN/UNF)	Ft. lbs. (In. lbs.)	Into Alum. Or Brass Ft. lbs. (in. lbs.)	Ft. lbs. (In. lbs.)	Into Alum. Or Brass Ft. lbs. (in. lbs.)	Ft. lbs. (In. lbs.)	Into Alum. Or Brass Ft. lbs. (in. lbs.)	Ft. lbs. (In. lbs.)	Into Alum. Or Brass Ft. lbs. (in. lbs.)	Ft. lbs. (In. lbs.)	Into Alum. Or Brass Ft. lbs. (in. lbs.)	Ft. lbs. (In. lbs.)	Into Alum. Or Brass Ft. lbs. (in. lbs.)
2	5/16-24	-	-	(85)	(55)	-	-	(60)	(39)	(30)	(19.5)	(85)	(55)
3	3/8-24	-	-	(155)	(101)	-	-	(100)	(65)	(55)	(36)	(155)	(101)
4	7/16-20	(310)	(201.5)	(260)	(169)	(180)	(117)	(180)	(117)	(120)	(78)	(260)	(169)
5	1/2-20	(360)	(234)	(280)	(182)	(360)	(234)	(250)	(162.5)	(170)	(110.5)	(280)	(182)
6	9/16-18	(420)	(283)	(350)	(227.5)	(420)	(273)	(350)	(227.5)	(410)	(266.5)	(350)	(175)
8	3/4-16	60	39	(620)	(403)	60	39	(620)	(217)	60	39	(620)	(403)
10	7/8-14	100	65	85	55	100	65	85	55.25	100	65	85	55
12	1 1/16-12	135	88	135	88	135	88	135	88	135	88	135	88
14	1 3/16-12	175	114	175	114	175	114	175	114	175	114	175	114
16	1 5/16-12	200	130	200	130	200	130	200	130	200	130	200	130
20	1 5/8-12	250	162.5	250	162.5	250	162.5	250	162.5	250	162.5	250	162.5
24	1 7/8-12	305	198	305	198	305	198	305	198	305	198	305	198
32	2 1/2-12	375	244	375	244	375	244	375	244	375	244	375	244

HYDRAULIC FITTING TORQUE SPECIFICATIONS

Code 61 and 62 Flange Recommended Bolt Torques

Steps to Properly Assemble the Flange Port Clamping Bolts:

1. Inspect components to ensure that male and female port threads and sealing surfaces are free of burrs, nicks and scratches, or any foreign material.
2. Lubricate the O-ring
3. Position flange and clamp halves
4. Place lock washers on bolts and insert through clamp halves
5. Hand tighten bolts.
6. Torque bolts in diagonal sequence in small increments to the appropriate torque level **refer to the table below.

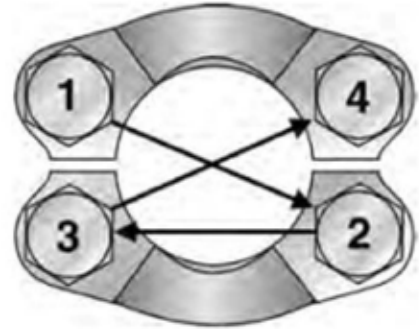

Flange Bolt Tightening Sequence

Code 61						Code 62					
Dash Size	Flange Size	Inch Bolt (SAE J518)	Torque ft. lbs.	Metric Bolt (ISO 6162)	Torque N-m	Dash Size	Flange Size	Inch Bolt (SAE J518)	Torque ft. lbs.	Metric Bolt (ISO 6162)	Torque N-m
8	1/2	5/16-18	17 ± 2	M8	24	8	1/2	5/16-18	17 ± 2	M8	24
12	3/4	3/8-16	31	M10	50	12	3/4	3/8-16	31	M10	50
16	1	3/8-16	31 ± 4.5	M10	50	16	1	7/16-14	52	M12	92
20	1-1/4	7/16-14	52	M12	50	20	1-1/4	1/2-13	77	M14	130
24	1-1/2	1/2-13	77	M12	92	24	1-1/2	5/8-11	155	M16	210
32	2	1/2-13	77	M12	92	32	2	3/4-10	265	M20	400
40	2-1/2	1/2-13	77	M12	92						
48	3	5/8-11	155	M16	210						
56	3-1/2	5/8-11	155	M16	210						
64	4	5/8-11	155	M16	210						
80	5	5/8-11	155	M16	210						

37° Flare (JIC) Assembly Torques and FFWR					
SAE Dash Size	Thread Size	Assembly Torque (+10%-0)		Tube Connection FFWR	Swivel Nut or Hose Connection FFWR
		In. lb.	ft. lb.		
-2	5/16-24	35	3	-	-
-3	3/8-24	65	5	-	-
-4	7/16-20	155	13	2 1/2	2
-5	1/2-20	165	14	2	2
-6	9/16-18	265	22	2	1 1/2
-8	3/4-16	505	42	2	1 1/2
-10	7/8-14	720	60	1 1/2	1 1/2
-12	1 1/16-12	1000	84	1 1/2	1 1/4
-14	1 3/16-12	1200	100	1 1/2	1 1/4
-16	1 5/16-12	1415	118	1 1/2	1
-20	1 5/8-12	2015	168	1	1
-24	1 7/8-12	2340	195	1	1
-32	2 1/2-12	3180	265	1	1
-40	3-12	-	-	1	1

SET-UP & ASSEMBLY

WHEELS & TIRES

The Mixer is shipped without the rims and tires installed on the axle hubs. Install the rims and tires, and torque the wheel nuts to 90 ft.-lbs. (124 N-m). Inflate the 12.5L x 15 - 20 ply tires to 80 PSI (563 kpa).

STORAGE

IMPORTANT: NEVER store the Mixer outside as the combination of product & water will create a paste and potentially plug the Mixer.

TRANSPORTING

TRANSPORT LIGHTING

Highway transport lighting is standard equipment.



REFLECTORS

The Mixer is equipped with red reflector strips that are located on the rear of each fender.

PREPARING FOR OPERATION

TRACTOR CONNECTIONS

PTO

Fasten the Mixer to the tractor drawbar with a hitch pin with safety locking device, and attach the Mixer PTO to the tractor PTO shaft locking it into position.

1. Maintain a straight alignment between the Mixer and the tractor.
2. Maintain a 15-1/2" distance between the lock on the tractor PTO and hole on Mixer hitch for a 540 RPM machine.
3. Maintain a 17" distance between the lock on the tractor PTO and hole on grinder-mixer hitch for a 1000 RPM machine.
4. Maintain a distance of 6"- 12" between the top of the tractor drawbar and the center of the tractor PTO. An 8" distance is standard.



Hydraulics

The Mixer requires a 4 hose hook-up; 2 hoses for the discharge auger lift, and 2 hoses for the discharge auger rotation.

PREPARING MIXER

- Properly lubricate the Mixer, checking the gearbox oil level, and filling if necessary before operating the Mixer.
- The tank lid and the discharge auger door must be closed.
- Follow the procedures outlined in the [Operation Chapter](#) of this manual for installing the mill screen.
- Start the tractor, engage the PTO at idle speed and increase the rpm's until the Mixer is running at the rated PTO speed. Begin the process.

OPERATION

EMERGENCY SHUTDOWN

In an emergency or in case a foreign object enters the mill, stop mixer operation immediately by disengaging the tractor PTO.

GENERAL INFORMATION

Check entire unit carefully before first operation. Tighten bolts and set screws that might have come loose in shipping. Lubricate as explained in the Lubrication Chapter in this manual.

The Mill is designed to receive dry grain from an auger, process it, and deposit it via the discharge auger. Be familiar with the machine before starting.

In addition to the design and configuration of equipment, hazard control and accident prevention are dependent upon the awareness, concern, and prudence of personnel involved in the operation, transportation, maintenance and storage of equipment or in the use and maintenance of facilities.

It is the responsibility of the owner or operator to read this manual and to train all other operators before they start working with the machine.

Follow all safety instructions exactly. Safety is everyone's business. By following recommended procedures, a safe working environment is provided for the operator, bystanders and the area around the work site. Untrained operators are not qualified to operate the machine.

Many features incorporated into this machine are the result of suggestions made by customers like you. Read this manual carefully to learn how to operate the machine safely and efficiently. By following the operating instructions, in conjunction with a good maintenance program, your Roller Mixer will provide you with many years of trouble-free service.

NOTE: The following procedures must be done before & during operation;

- 1.) *The hopper shut-off is open.*
- 2.) *The tank lid is closed & the collector cover is open.*
- 3.) *The unloading auger shut-off door is closed.*
- 4.) Operate the mixer on level ground for uniformity of mix.
- 5.) Maintain a straight-line alignment between the tractor and mixer to prolong the life of the drive line components.
- 6.) Maintain the tractor rated PTO speed to obtain the highest efficiency.
- 7.) Add supplements after a small amount of feed has been ground, then dry granular materials.

NOTE: *Do not grind grains with high moisture content. This may cause plugging. Abnormally damp crops will not feed or mix well.*

When the feed in the top windows begins to drop the 1st time, grinding should be discontinued .

IMPORTANT: *Overfilling the mixing tank will place unnecessary stress on the drive line components. Keep the tank lid closed and latched so that if the tank is accidentally overfilled, the lid can pop open and release the feed inside the tank.*

NOTE: *Optional models of electronic scales are available for accurate weight measurements and rations.*

Allow the mixer to continue running for several minutes to thoroughly mix the rolled feed and supplements.

IMPORTANT: *When transporting a load any distance, disengage the mill following the safety procedures, then re-start the mixer allowing it to continue to run to eliminate any settling of feed in the tank that may cause the Mixer to have a hard time restarting. Disengage the tractor PTO before turning corners to prevent damage to the PTO driveline - Re-engage the PTO after turning the corner.*

OPERATION

OPERATING THE GRINDER MIXER

1. Make sure to read and understand all of the safety items in this manual
2. Always ensure that main drive belt tension is adequate.
3. If not using the Mill for some time, clean any excess grain out of the intake auger area.
4. Best practice is to store the mill under cover.

IMPORTANT: When starting the Grinder-Mixer, engage the tractor PTO at a slow idle speed. Advance the throttle of the tractor to the rated PTO speed.

BREAK-IN

It is recommended that the Mill be run at at 1/2 to 2/3 capacity during the first hour of operation. This allows the frictional forces to diminish significantly within the auger tube and allows the flow of grain to approach acceptable levels in the system. Keep this in mind after the Mill has been stored for extended periods of time as well. It is also recommended that the following mechanical items be checked:

After operating for a 1/2 hour:

- Re-torque all fasteners and hardware.
- Lubricate all grease fittings.

After 5 hours and 10 hours of operation:

- Re-torque all wheel bolts, fasteners and hardware.
- Lubricate all grease fittings - do not over-grease.

CAPACITY

The tank will hold approximately 6000 lbs. of ground feed consisting of average weight corn. More or less weight (per tank) is possible, depending upon whether the material that is being rolled is lighter or heavier than average. Capacity of the mill will vary due to the type of material being ground, the moisture content of the material, and the horsepower of the tractor used to operate the mixer.

The mixer is designated for operation by a 70 to 125 PTO HP tractor with a 540 RPM PTO.

540/1000 RPM PTO DRIVE

The H&S GM 170 grinder-mixer features a 540 drive as standard equipment for use with tractors up to 115 hp (86 kW).

An optional 1000 RPM drive is available for use with tractors up to 145 hp (109 kW).



MILL & BLOWER

Drive Sheave

The mill/blower can be engaged or disengaged by the positioning of a pin on the sheave.

To disengage the mill/blower, grasp the pin handle, pull it forward and rotate it onto the L-shaped bracket.

IMPORTANT: When starting the Grinder-Mixer, engage the tractor PTO at a slow idle speed. Advance the throttle of the tractor to the rated PTO speed.

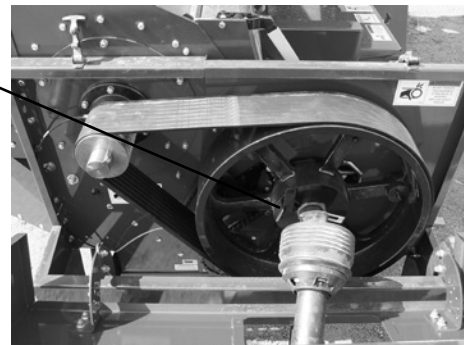

OPERATION

Mill & Blower Operation

Material enters the cylinder chamber through the mill inlet and is drawn into the cylinder by a vacuum below the cylinder. The vacuum below the cylinder is obtained by the physical location of the blower Inlet below the cylinder.

The 21" cylinder is composed of sixty-six swinging hammers which are equally divided among three rows around the cylinder. As the cylinder rotates at the recommended speed of 2700 RPM, the hammers grind the material and force it through the screen. Once through the screen, the ground material drops down to the transfer auger and is conveyed to the mixing tank. Lightweight chaff or dust is drawn into the blower inlet and forced by the blower up into the collector where it is refined and separated. Heavy particles are directed back down into the transfer auger and conveyed to the mixing tank.



GRAVITY FEEDER

The standard equipment gravity feeder is a stationary hopper with no moving or running parts. Material to be ground is dumped into the hopper and slides directly into the mill inlet. A combination steel/rubber splash plate prevents the material which is being fed from being kicked out by the mill cylinder.



MAGNETS

Two heavy-duty 4" x 18" magnets located in the gravity feed hopper remove any metal that may accidentally mix with the material entering the mill.

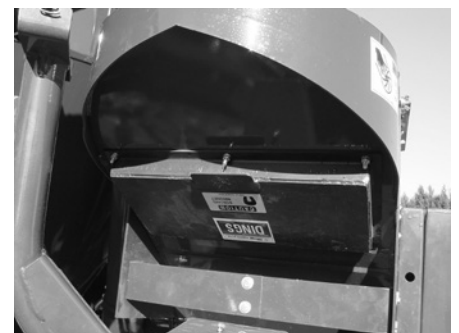

TANK LID

The lid on top of the mixing tank features spring-loaded latches which enables it to be forced open by overflowing material should the tank accidentally become filled beyond capacity. The tank lid will open, allowing the ground feed to spill-out to prevent damage to the mixing auger and drive components.

IMPORTANT: Stop mixer operation if the tank lid is forced open. Before restarting to grind or mix, the tank lid must be closed and latches.



OPERATION

SELF-CONTAINED HYDRAULIC SYSTEM

Hydraulic System

The mixer has a self-contained hydraulic system composed of a pump, reservoir w/oil filter, and hydraulic motor operated discharge augers.



Note: When operating at cold temperatures, allow the hydraulic oil in the self-contained system to warm up at tractor idle speed with the PTO running prior to grinding.

Discharge Auger System

Ground feed from the mixing tank is discharged by an auger system consisting of three hydraulically motor driven augers that are connected in series so that all augers are synchronized as well as started and stopped together. If any motor malfunctions, the movement of material through the augers will stop immediately. The length of the unloading auger is approximately 12 feet, without any extensions. By adding a 3' or 6' folding extensions, the length can be increased. A transport cradle is provided for holding the unloading auger in position during transport.

Needle Valves

An adjustable needle valve is provided on each hose of the discharge auger rotation to control the speed of auger swing to provide smooth rotation. Needle valves are located at the rear of the machine by the hydraulic rotation motor. See the Adjustment Chapter of the manual for adjustment details.

Discharge Auger Door & Hydraulic On/Off Valve

An on/off valve with a pressure relief controls the hydraulic motors which operate at a single constant speed determined by the speed of the tractor PTO. A discharge auger shut-off door and flow control valve is provided to regulate the amount of feed passing into the discharge auger. For maximum unload performance, do not run the hydraulic system no more than 2500 p.s.i. (see gauge) Running over 2500 p.s.i. will result in plugging the discharge auger system.

NOTE: Always activate the hydraulic on/off valve to engage the discharge augers before opening the discharge auger shut-off door. Adjust the flow control and the door opening so that the proper p.s.i. is maintained that is listed on the decal. When the mixing tank has been unloaded, close the discharge auger shut-off door then shut-off the hydraulic on/off valve .



OPERATION

SUPPLEMENT HOPPER

Snubbers lock the lid on the Supplement Hopper into the closed position. A bag guard is provided to prevent containers from being accidentally drawn into the transfer auger. A flip-over bag breaker allows easy opening of supplement bags.

NOTE: Liquids, such as molasses, should not be poured into the grinder-mixer as it will cause build-up within various parts of the mixer.



OPTIONAL REAR SUPPLEMENT HOPPER

A rear Supplement Hopper is available in addition to the standard side Supplement Hopper.

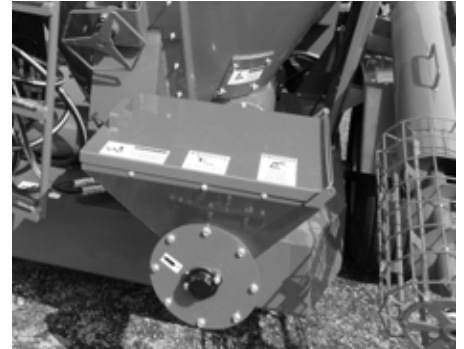

SCREENS

Uniformity of grinding is a factor of mill speed, condition of the hammers, and sharpness of the screen. The efficiency of the mill will also decrease if the holes of the screen are badly worn. If grinding fineness is deteriorating, the screen should be rotated to place the sharp holes edges against the direction of the cylinder rotation or the screen should be replaced. The Mixer can be fitted with numerous screens that are available with various size holes to accommodate different material and grinding requirements. A screen storage rack is provided on the left side of the mixer.



NOTE: If a screen is correctly installed, it should fit tight against the mill throat plate and butt tightly against the mill frame hood sheet when the mill screen cover is closed and securely latched.



The listing below are only suggested hole size recommendations for different materials:

Fine Grind	Small Grains: 1/8", 3/16"
Medium Grind	Small Grains: 3/16", 1/4", 5/16"
Coarse Grind	Small Grains: 3/8", 1/2", 5/8"
Fine Grind	Shelled Corn: 1/8", 3/16", 1/4", 5/16"
Medium Grind	Shelled Corn: 3/8", 1/2", 5/8"
Coarse Grind	Shelled Corn: 3/4", 1"
Fine Grind	Ear Corn: 1/4", 5/16", 3/8"
Medium Grind	Ear Corn: 1/2", 5/8"
Coarse Grind	Ear Corn: 3/4", 1", 1-1/4", 1-1/2"

OPERATION

UNPLUGGING

IMPORTANT: *When plugging is detected, stop mixer operation.*

Mill, Mill Drive and Mixing Tank

Overfeeding of the mill and/or the mill inlet can result in plugging, thus slipping of the miller/blower drive belt, or shearing the main shear bolt. Abnormal crop conditions would include crops with high moisture content or crops that are too light or bulky which would not feed properly.

Overfeeding

If plugging develops from overfeeding, the tractor will choke down and even stall. To remove the plugging, proceed as follows:

1. Shut the tractor off, remove key, disengage the PTO, detach the PTO and hydraulic hoses from the tractor.
2. Shut off the feeder attachment (if applicable).
3. Open the mill screen cover, remove the screen and allow the material to fall down into the transfer auger or remove material if the transfer auger is overloaded. Close mill cover.
4. Disengage the mill/blower drive sheave pin.
5. Start the tractor and engage the PTO at slow speed to convey the material into the Tank.
6. Shut the tractor off and disengage the PTO.
7. Open the mill screen cover, replace the mill screen, close mill cover, engage the mill/blower drive sheave pin, and restart the tractor and PTO.
8. Bring the mill up to proper running speed and restart the feeder attachment (if applicable). If the condition of the crop remains the same, reduce the feeding speed to avoid overfeeding.

MILL/BLOWER DRIVE BELT SLIPPAGE

Overload protection for the mill and blower components is provided by an 8 "A" section drive belt, which connects the mill/blower driven sheave to the drive sheave. The mill and blower will gradually slow down without much reduction in tractor PTO speed if plugging develops from mill/blower drive belt slippage. Stop turning the mill/blower drive shaft if plugging or breakdown occurs in the mill or blower areas. Follow steps 1 through 5 from OVERFEEDING to remove the plugging. After the plugging has been removed, shut the tractor off, disengage the PTO, and adjust the drive belt tension to the proper tension (see [Adjustment Chapter](#)). Restart the tractor and PTO, bring the mill cylinder up to proper operating speed and resume grinding.

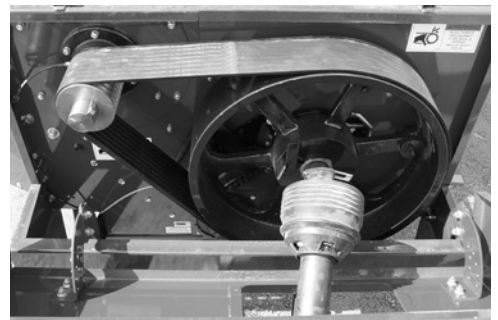

IMPORTANT: *Stop mixer operation if drive belt slipping is detected.*

OPERATION

BLOWER INLET & OUTLET

NOTE: The collector cover must always be open while grinding.

Plugging in the blower inlet or outlet can be seen by the abnormal amount of dust particles in the air around the top of the collector, and/or the visible presence of dust in the mill throat area and/or a reduced air discharge at the top of the collector. If plugging is detected, proceed as follows:

Blower Inlet

1. Stop the tractor engine, remove ignition key, allow all mechanisms to stop and disengage PTO.
2. Open the mill screen cover and remove the screen.
3. Inspect the blower inlet opening and remove any buildup.

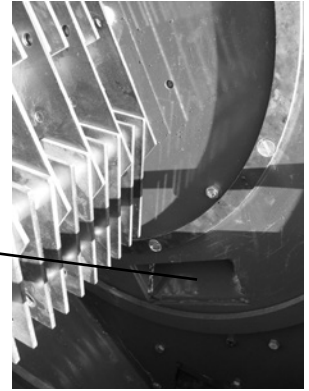

Collector

4. If there is no air coming out the top of the collector, the plugging is in the discharge side (blower outlet). Remove and clean out the tube connected to the blower outlet. Climb the ladder and check the inside of the collector. If the cyclone is plugged, remove the pipe below the cyclone and dislodge the plugging material.
5. After the plugging has been removed, replace the screen, close and latch the mill screen cover and attempt to resume grinding.



ADJUSTMENTS

DRIVE CHAIN

Chain tension is self-adjusted by a spring-loaded idler and requires very little adjustment. There should be approximately a 1/8" gap between the spring coils for proper tension. The chain, sprockets, and spring should all be inspected periodically for signs of wear.



NEEDLE VALVES

An adjustable needle valve is provided on each hose of the discharge auger rotation to control the speed of auger swing to provide smooth rotation. Needle valves are located at the rear of the machine by the hydraulic rotation motor. Unlock the set screw on the valve - adjust each valve by dialing it left or right to decrease or increase auger rotation speed. After the speed has been set, lock the set screw down.

TANK LID

The tank lid on top of the mixing tank is designed to be self-unlatching in the event that the mixing tank accidentally becomes overfilled. The latching mechanism should be properly adjusted by the latch nut to maintain proper tension on the lid to keep it closed and weather-tight, but still allow it to be forced open from the inside of the tank by overflowing material. If the latch handle can be pulled straight up approximately 1/2" (12 mm), completely compressing the spring, tension is correct.

IMPORTANT: *The latch springs should never be completely compressed when the handle is all the way down or the lid will not open during over filling.*



12' DISCHARGE AUGER

Transport Cradle

The unloading auger must always be moved to and set into the transport cradle before the mixer is transported. If the auger does not set in the cradle, adjust the stop bolt on the vertical rotating auger at the rear of the machine.

3' & 6' Discharge Auger Extensions

The 3' and 6' discharge auger extensions fold back and lock into position with a safety lock pin. If the main pin does not line up with the hole on the bracket of the standard 12' auger, loosen the bolts and adjust the bracket.

ADJUSTMENTS

MILL/BLOWER DRIVE

The combination mill/blower driven sheave is connected from the main drive sheave by an 8" "A" section banded drive belt. Adjusting bolts are provided to align the drive sheave with the driven sheave as well as to adjust the drive belt tension.

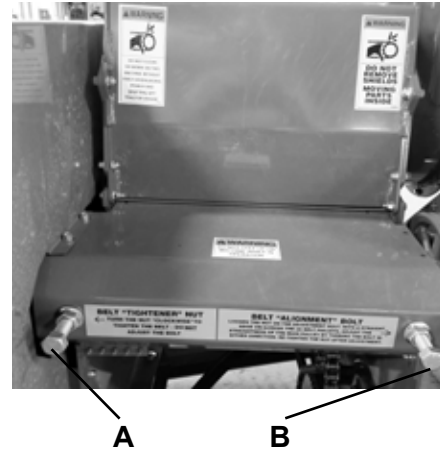

Sheave Alignment

To align the combination mill/blower driven sheave with the drive sheave, proceed as follows:

1. Loosen both of the bolt/nut (A & B) assemblies on the main drive shaft.
2. Place a straightedge across the faces of both sheaves (C & D) to check alignment.
3. Adjust the nut on the left bolt assembly (A) and the bolt on the right side assembly (B) to bring the drive sheave into alignment with the driven sheave.
4. After proper alignment is obtained, check and adjust drive belt tension.

Belt Tension

To adjust mill/blower drive belt tension, proceed as follows:

1. Check the drive belt tension initially by measuring the amount of belt deflection at the midway point between the sheaves while applying 60 lbs. of force at the midway point.
2. Adjust the nut on the left bolt assembly (A) clockwise to decrease deflection (increase tension) and adjust the right side bolt assembly (B) an equal number of turns counterclockwise to keep drive sheave in alignment with driven sheave. Adjust both sides until the deflection measures 3/8" (10 mm).
3. After proper tension is obtained, check for correct sheave alignment, retighten the lock nut on the right side bolt.

NOTE: A new drive belt should be adjusted for an initial tension of 3/8" (10 mm) deflection with an applied pressure of 80 lbs. (360 N). Refer to the Service Chapter of this manual for new belt installation procedures.

ADJUSTMENTS

SWINGING INTAKE AUGER ATTACHMENT

SIA Brake Tension

A brake lever adjusts the hold and horizontal position of the swinging intake auger attachment. The brake mechanism consists of a cam-type lever-activated mechanism which is connected to a band around the attachment pivot. An adjustment bolt on the opposite end of the lever can be turned in to tighten, or out to loosen the band around the pivot. The bolt should be adjusted so when the brake lever is at a right angle to the pivot, there is no binding or restriction when the auger is swung. When the brake lever is straight out, there should be tight clamping around the pivot and the auger is firmly held in place.



SIA Counterbalance Spring Tension

The Swinging Intake Auger (SIA) attachment is spring counterbalanced to facilitate lifting the attachment. There are multiple holes in the spring attachment bracket to select the appropriate SIA lift tension. The spring should provide enough tension to conveniently raise the SIA and still allow the SIA to remain stationary when the intake hopper end is lowered to the ground.



MILL SCREEN COVER LATCHES

Over-center handle latches are used to secure the mill cover tightly closed while the mill is being operated.

Lock nuts on the bolts of the latches are used to adjust latching tension. This tension should be adjusted and maintained so that some force has to be applied on the handles to lock and unlock them. Both latch mechanisms should be adjusted equally.

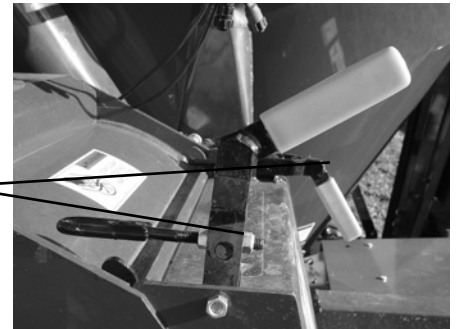

TANK LID

The tank lid on top of the mixing tank is designed to be self-unlatching in the event that the mixing tank accidentally becomes overfilled. The latching mechanism should be properly adjusted by the latch nut to maintain proper tension on the lid to keep it closed and weather-tight, but still allow it to be forced open from the inside of the tank by overflowing material. If the latch handle can be pulled straight up approximately ½" (12 mm), completely compressing the spring, tension is correct.

IMPORTANT: *The latch springs should never be completely compressed when the handle is all the way down or the lid will not open during over filling.*

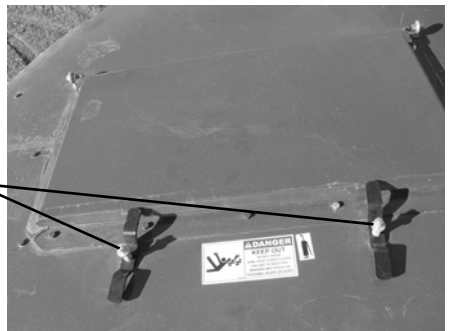

ADJUSTMENTS

NEEDLE VALVES

An adjustable needle valve is provided on each hose of the discharge auger rotation to control the speed of auger swing to provide smooth rotation. Needle valves are located at the rear of the machine by the hydraulic rotation motor. Unlock the set screw on the valve. Adjust each valve by dialing it left or right to decrease or increase auger rotation speed. After the speed has been set, lock the set screw down.



12' DISCHARGE AUGER

Transport Cradle

The unloading auger must always be moved to and set into the transport cradle before the mixer is transported. If the auger does not set in the cradle, adjust the stop bolt on the vertical rotating auger at the rear of the machine.



3' & 6' Discharge Auger Extensions

The 3' and 6' discharge auger extensions fold back and lock into position with a safety lock pin. If the main pin does not line up with the hole on the bracket of the standard 12' auger, loosen the bolts and adjust the bracket.

SERVICE

HYDRAULIC SYSTEM

Hydraulic Pump Sheave Alignment

The hydraulic pump drive and driven sheaves must be maintained in correct alignment and be tightly secured at all times.

Hydraulic Pump Belt Tension

Overload protection for the hydraulic pump is provided by a self-adjusting spring tightener that requires no adjustment. The idler pulley must be properly positioned to keep the belt aligned with the sheaves.

Hydraulic Reservoir

The oil filter should be replaced once a year or every 75 hours of operation, whichever comes first. The oil should be drained and replaced every two years or every 150 hours of operation, whichever comes first. Keep oil filled to proper level.

OVERLOAD PROTECTION

Gearbox/Mixing Auger Shear Bolt

The mixer is furnished with a shear bolt protecting the gearbox and mixing auger. When the shear bolt fails, the mixing auger will stop turning. This may be a result of an overfull tank, the lid did not release, an obstruction, or some other issue. Shut down the tractor and mixer, disconnect the PTO, and proceed as follows:

1. Clean any material out of the intake area possible with a scoop or shop vac..
2. Check for a broken chain, drive sprocket or driven sprocket or for sheared keys which hold the sprockets. Replace any damaged parts.
3. Replace the with the recommended shear bolt.
4. If the items in steps above are not at fault, remove the gearbox drive chain and attempt to rotate the gearbox input shaft. If the input shaft turns freely, internal transmission component failure is probable. Remove the gearbox and take it to your nearest dealer for repair.

After the cause of the plugging has been corrected, reinstall all components, guards and shields before resuming operation.

IMPORTANT: Stop mixer operation when the shear bolt fails.

ENGAGING PIN

The pin used to engage and disengage the mill/blower drive sheave should be checked periodically for excessive wear or improper seating. Excessive wear on the pin or the hole in the hub that the pin engages could result in the pin accidentally disengaging in the middle of mill and blower operation. Both components should be replaced if worn.

IMPORTANT: Do not start the PTO until the pin is positively engaged. Using the PTO to engage the pin will cause premature pin failure.



SERVICE

MILL/BLOWER DRIVE

Belt Replacement

To replace the mill/blower drive belt, perform the following steps:

1. Disengage PTO, shut-off tractor and remove key.
2. Release front drive chain tension.
3. Loosen both of the bolt/nut (A & B) assemblies on the main drive shaft.
4. After tension is released, remove the old belt and replace with a new belt.
5. Adjust the new belt tension per the Adjustment Chapter of this manual. After tension is properly adjusted, reconnect the front drive chain idler bracket spring.

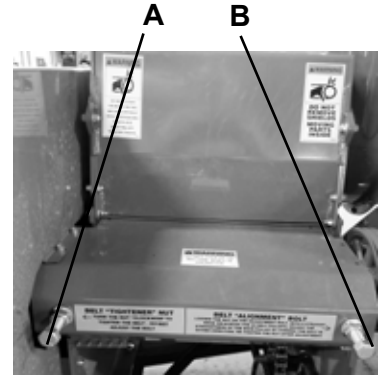

IMPORTANT: *The mill/blower drive belt will deteriorate more rapidly if improper tension is applied. Uneven sheave alignment will result in uneven belt stretch. Improper mill/blower belt tension will produce excessive pressure on the mill/blower bearings and cause premature bearing failure.*

MILL HAMMER ROTATION OR REPLACEMENT

To maintain maximum grinding efficiency, the mill hammers should be rotated before wear radius measures $\frac{1}{4}$ " (6 mm). Mill hammers are designed to be conveniently removed and rotated through 4 positions, before they require replacement. The hammers should be replaced when all four corners are worn to $\frac{1}{4}$ " (6 mm) radius.

The mill cylinder contains 3 rows with 22 hammers in each row. To remove a row of hammers, rotate the cylinder to the position where the row of hammers to be removed lines up with the access hole in the left side of the mill housing. With the access hole cover removed, pull the cotter pins out of the ends of the hammer rod and pull the rod out through the access hole.



NOTE: *Use a catch pan or install a small screen below the rod for the hammers and spacers to drop into as the rod is being pulled out.*

IMPORTANT: *Hammers and spacers must be replaced in proper sequence with respect to the appropriate row on the cylinder. When the hammers are rotated they should always be rotated in the same direction to maintain a balanced cylinder. All 3 rows of hammers should be rotated at the same time or replaced at the same time.*

After the hammer rod is replaced and all of the hammers and spacers have been replaced, secure the rods in place with a new $\frac{3}{16}$ x $1\text{-}1/4$ " cotter pins. Spread the points and bend them around the rod. Replace the access hole cover.

SERVICE

MAIN DRIVE SHAFT BEARINGS

Main drive shaft bearings are greased by 2 of the remote zerks in grease bank under the step by the mill cover. For bearing replacement, follow steps 1-5 from the previous Belt Replacement section in this chapter. Then:

1. Disengage PTO, shut-off tractor and remove key.
2. Remove the hydraulic pump belt shield.
3. Release the spring tension on the hydraulic pump drive belt.
4. Remove the hydraulic drive pulley on the end of the main shaft.
5. Remove the drive chain to the transfer shaft.
6. Remove the PTO.
7. Remove the flywheel and flywheel clutch.
8. Remove the back left flywheel shield.
9. Remove remote grease lines from bearing blocks.
10. Remove main driveshaft cover with shaft and bearings.
11. Remove shaft and bearings from cover.
12. Loosen set screws and remove bearings.
13. Install new bearings and tighten set screws.
14. Reinstall components in reverse order.
15. The bolt securing the PTO to the shaft should be tightened to seat the bearings. Then back the bolt out and tighten to 6-10 inch lbs. of torque. Secure the bolt with wire to PTO yoke.

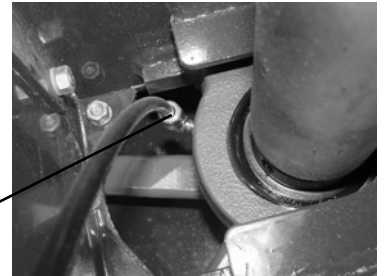

MILL THROAT PLATE

The mill throat plate must be properly adjusted to hold the screen in place when the mill screen cover is closed and latched. Adjust the throat plate position with the two bolts on each side of the mill housing. To adjust the throat plate:

1. Disengage PTO, shut-off tractor and remove key.
2. Open the mill screen cover and install a screen into the screen support.
3. Loosen, but do not remove the four adjustment bolts and position the throat plate toward the bottoms of their mounting slots, then partially tighten the bolts.
4. Close the mill screen cover while forcing the screen against the throat plate.
5. Before latching the cover, tightly secure the four adjustment bolts to lock the throat plate position.

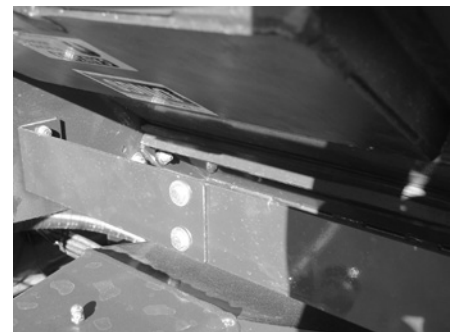

NOTE: *The throat plate position should be adjusted regularly to maintain proper mill/screen operation and cover latching, and to prevent material from dropping out the bottom of the mill.*

SERVICE

UNLOADING AUGER

If the Unloading Auger System becomes plugged, proceed as follows:

1. Disengage the PTO, shut-off tractor and remove key.
2. Shut the unload auger door and turn off the on/off control valve to the OFF position.
3. Remove the clean-out cover on the vertical unloading auger, and the end cover/bearing on the lower horizontal auger. Remove as much material as possible.
4. Replace the end cover/bearing on the lower horizontal auger, and the vertical unloading auger cleanout cover.
5. Hydraulically lower the main discharge auger to the lowest position.
6. Re-open the flow control valve for the lower auger keeping the discharge auger unloading door closed.
7. Re-start the tractor, engage the PTO, and turn on the on/off control valve to clear the remaining material from the discharge augers.
8. Open the discharge auger unloading door making sure that the hydraulic gauge pressure does not exceed 2500 p.s.i.

NOTE: *If the plugging is due to an improperly attached extension, check and correct before attempting to resume unloading.*

TIRES & WHEELS

Check the Tire pressure after every 50 hours of operation. Tires should be inflated to 80 PSI (563 kpa). Wheel lugs torque should also be checked after every 50 hours of operation and tightened to 90 ft.-lb (124 Nm) torque.

OPTIONAL FEATURES & ACCESSORIES

UNLOADING AUGER EXTENSIONS

3' Folding Auger Extension

The 3' folding discharge auger extension kit consists of a 3' length of auger which is attached on a pivoting mounting bracket to the end of the 12' unloading auger, and a Cradle Extension.

NOTE: The 3' folding auger extension must be folded back and locked in position for transport if the tractor cab is an obstruction.



6' Folding Auger Extension

The 6' folding discharge auger extension kit consists of a 6' length of auger which is attached on a pivoting mounting bracket to the end of the 12' unloading auger, and a Cradle Extension.

NOTE: The 6' folding auger extension must be folded back and locked in position for transport if the tractor cab is an obstruction.



ELECTRONIC SCALES & COMPONENTS

Model: Digi-Star EZ 2500

An optional factory installed Digi-Star EZ 2500 scale is available for accurate weight measurement. The 3-point Weighbar System features 3 modes, Net, Tare and Gross.

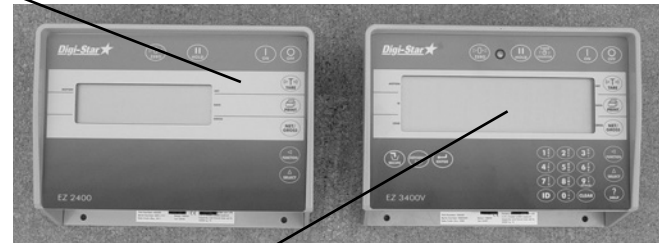

Model: Digi-Star EZ 3410 w/External Horn

An optional factory installed Digi-Star EZ 3410 scale is available with all the features of the EZ 2500, plus an external horn, and has the capability for entering rations.

NOTE: For operation and troubleshooting refer to the TopCon/Digi-Star user manual

Intake Auger

Optional Hydraulic Drive Intake Augers are available to convey material into the mill. The intake augers can be swung in and locked against the mixer tank support brace for transporting, or swung out and at any point. A speed control handle is provided for stopping and starting auger rotation, as well as regulating the feeding rate of material being fed into the mill hopper shields and screens are in place for your safety. Do not remove them.

LUBRICATION

GENERAL INFORMATION

IMPORTANT: *The Mixer must be properly lubricated, the gearbox and oil reservoir must be filled to the proper oil levels before it can be operated.*

IMPORTANT: *Catch and dispose of fluid per local waste disposal regulations whenever service is performed on hydraulic components (valves, cylinders, hoses, etc.) or gearbox.*

GEARBOX OIL LEVEL

NOTE: *Check the fluid level in the mixer gearbox periodically by removing the plug located on the transmission. Requirements: 1-1/2 U.S. Pints (0.7 liters) of SAE #140 Gear Lube.*

Check the gearbox occasionally for oil drips and dust accumulation around the seals. Oil drips or dust accumulation indicate that seals are leaking.

Water is present in the oil if the oil is tan in color and foams excessively. Drain and replace the lubricant immediately.

NOTE: *Fill the transmission gearbox to the bottom of the inspection plug hole - Do not overfill!*

OILING

The chains on the Mixer should be lubricated every 15-20 loads using a good grade of lubricant. Spray the entire chain on the center of the rollers.

OIL RESERVOIR

Check the oil reservoir daily. Oil level should be between Max/Min level marks. Fill as needed using Exxon Nuto H46 or Equivalent.

GREASE

Use an S.A.E. multi-purpose high temperature grease with extreme pressure (EP) performance. An S.A.E. multi-purpose lithium base grease is also acceptable.

1. Use only a hand-held grease gun for all greasing.
2. Wipe grease fittings with a clean cloth before greasing to avoid injecting dirt and grit.
3. Replace and repair broken fittings immediately.
4. If a fitting will not take grease, remove and clean thoroughly. Clean the lubricant passage-way also. Replace fittings as necessary.

WHEEL BEARING LUBRICATION, CLEAN & RE-PACK INSTRUCTIONS

Grease wheel bearings as needed through the zerks on each wheel hub depending on amount of travel .

Annually disassemble and clean parts in a solvent. Pack bearings with a high grade grease. Reassemble, and tighten nut until a slight drag is felt when wheel is turned. Back nut off and insert cotter pin into first hole that you see as you back the nut off, bend cotter pin over and reinstall cap.

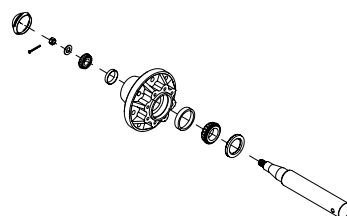

LUBRICATION



Telescoping PTO Drive (3 zerks)
Jack (1 zerk)



Transfer Auger & Main
Drive Shaft Front Bearings
(1 zerk each under shield)

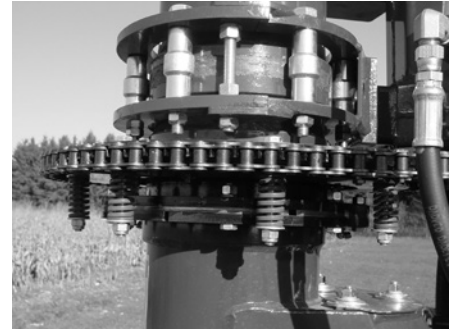

Unloading Auger Pivot Collar
(4 zerks - 2 on the top of the collar
& 2 on the bottom of the collar)

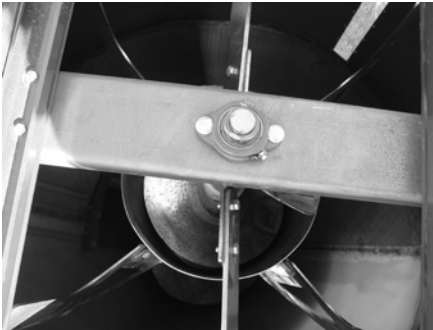

Top of Mixing Auger
(1 zerk - under top of tank cover)



Main Drive Shaft
Intermediate Bearing
(1 zerk under shield)



Unloading Auger (1 zerk on the top
of vertical section auger and 4
zerks on vertical auger pivot.)



#1 Discharge Auger Bearing
(1 zerk under shield)



Main Drive Shaft
U-Joints (1 zerk on each
end under shield)



Unloading Auger - (1 zerk at the
end of the auger discharge spout)



Intake Auger
(1 zerk)

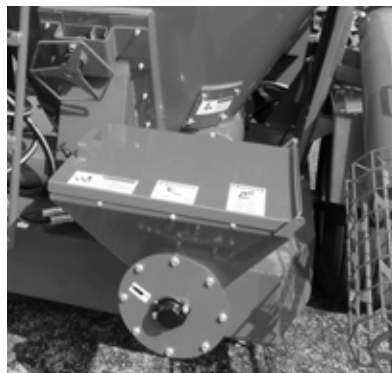

Supplement Hopper
Auger Bearing (1 zerk)



#1 Discharge
Auger End Bearing
(1 zerk)

DECAL LOCATION

Your H&S Mixer was manufactured with operator safety in mind. Located on the Mixer are various decals to aid in operation, and to warn of danger or caution areas. Pay close attention to all the decals on your Mixer.



DO NOT REMOVE ANY OF THESE DECALS. IF DECALS ARE LOST, DAMAGED, OR IF YOUR GRINDER-MIXER IS REPAINTED, REPLACE DECALS. REMEMBER: DECALS ARE FOR YOUR PROTECTION AND SAFETY.

Listed below are the decals on your Mixer. These decals may be ordered individually by part number.

<u>Part #</u>	<u>Qty</u>	<u>Description</u>
311	1	Patent Number
1494A	2	Do not operate this equipment if this decal is exposed.
1494J	3	Do not clean or work on this machine without first disengaging power
1494K	3	Do not remove shields - moving parts inside
1494L	1	Rotating driveline
1494P	3	Maintain safe clearance from electrical power lines
2495	1	Keep children away at all times
9194A	3	No step - stay clear
11210B	4	Do not remove shields - rotating parts inside
11599	5	Do not go near leaks
32597A	1	Do not operate this equipment if this decal is exposed.
51010	3	Pinch Point
54033	1	Made in USA 3"
66076	4	Located Behind Shield
72203A	1	Help avoid injury - Read and understand the operators manual
81209	5	Warning - Never Remove Panel with Machine Running
82602	2	Crushing Hazard
82907A	2	Stay clear of discharge auger
82907B	1	Stay clear of auger extension hinge area
82907C	2	Stay clear - Keep hands and feet away from auger at all times
82907D	3	Stay clear - Rotating parts inside
82907F	2	Keep out - Do not enter tank - Keep cover closed
82907G	2	Stay clear - Keep hands out of supplement hopper
82907I	2	Do not step up on machine while in operation
82907K	1	Cyclone Cover - Open/Close
82907L	3	Never allow riders on this machine
91358	2	Grinder Mixer Branding Decal
84044	1	FEMA Decal
84045	1	H&S Since 1967
91353	1	9117 Model # Decal
91357	1	Front Branding Decal
91393	1	Operation - Informational
91396	1	Belt Adjustment - Informational
91398	1	Pressure Adjustament - Informational
093020	16	Grease zerk Decal
093366	1	Keep Operator's Manual Here
11211176	2	Shear Bolts
DCRED	3	Red Reflector
DCAMB	2	Amber Reflector
TFM97	1	SMV Decal

DECAL LOCATION

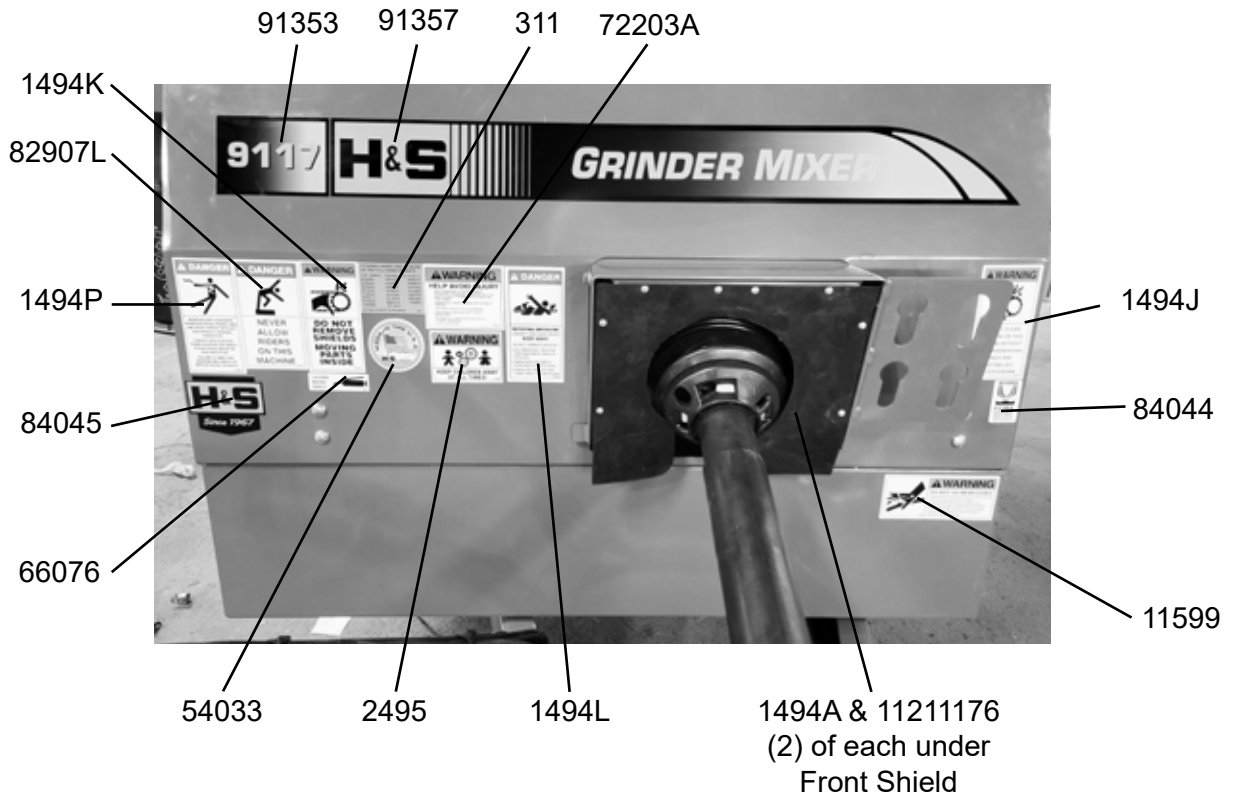

1494L 56877 093020 82602



82602

DECAL LOCATION

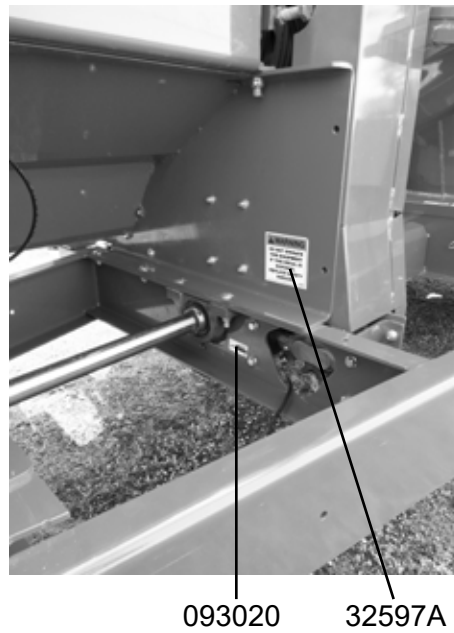
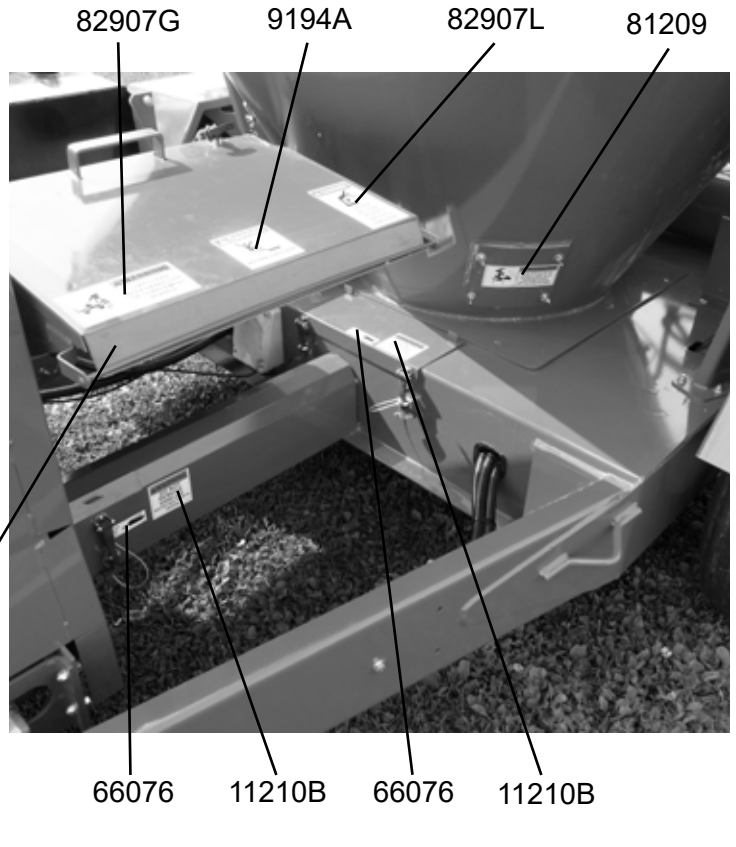
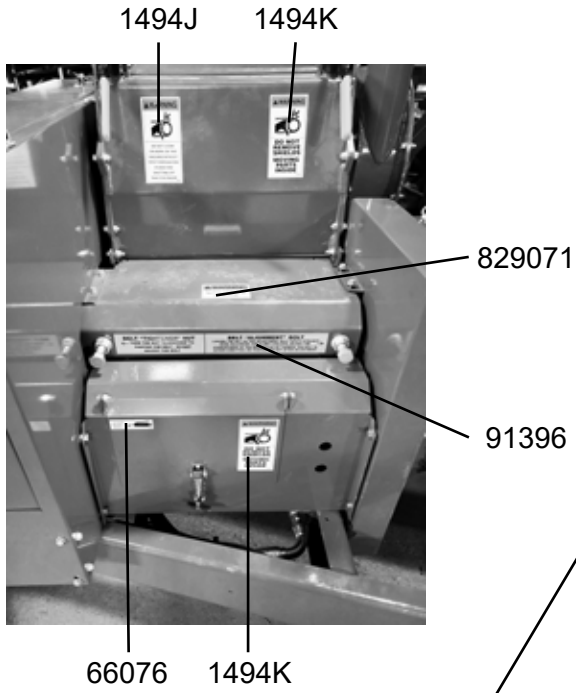

DECAL LOCATION

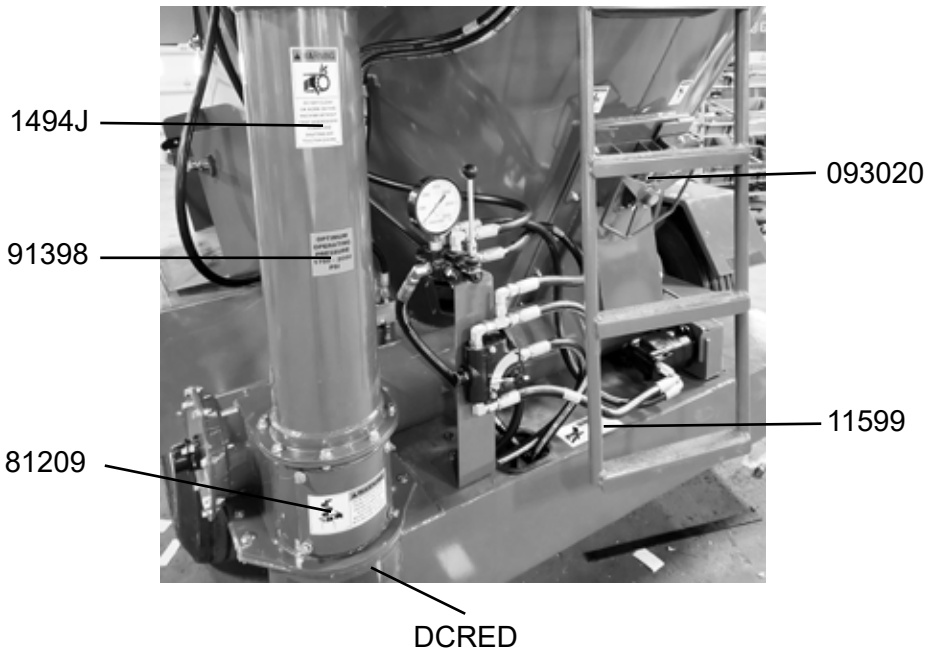
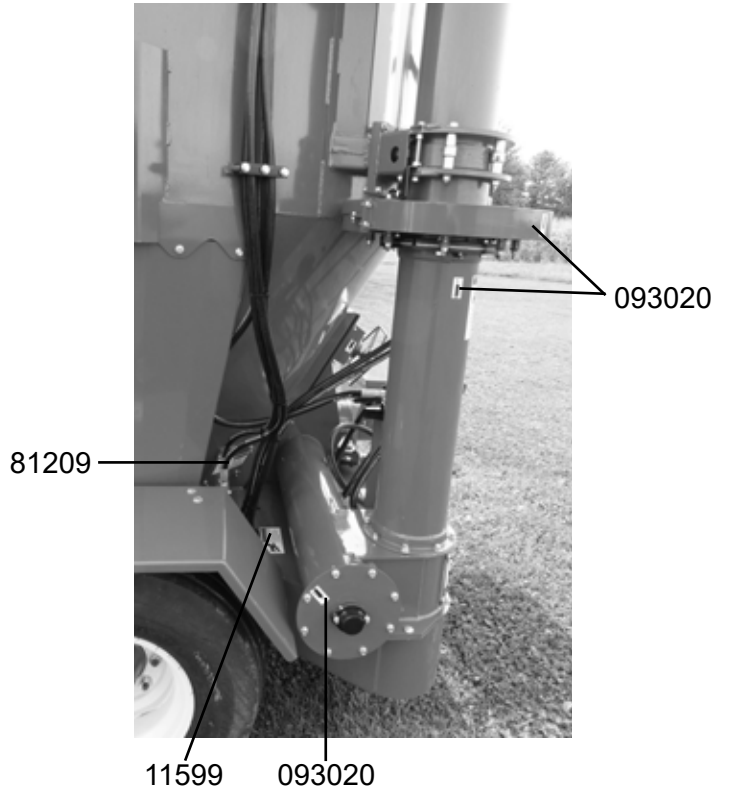

DECAL LOCATION

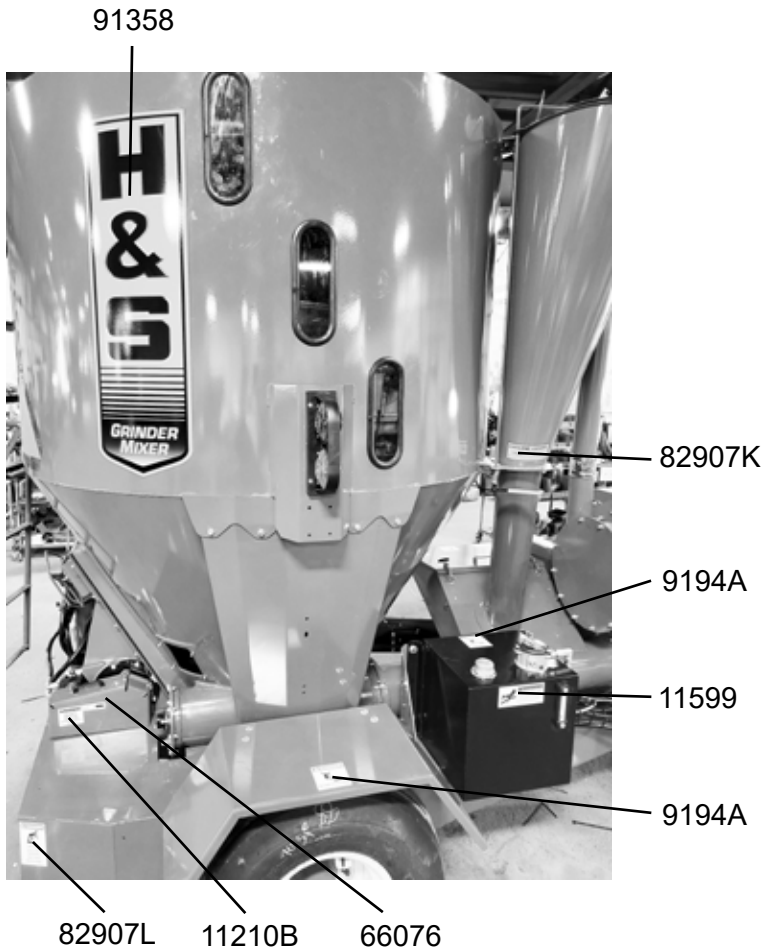
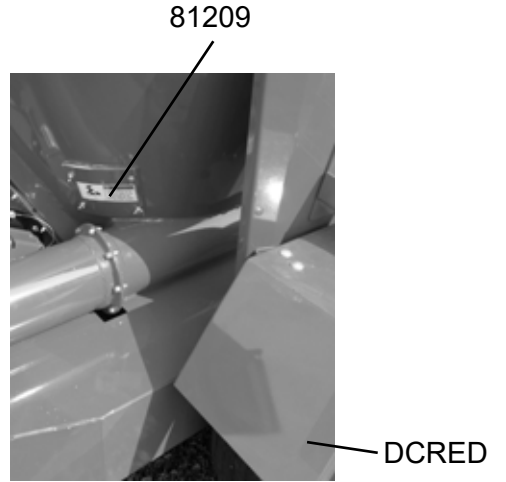
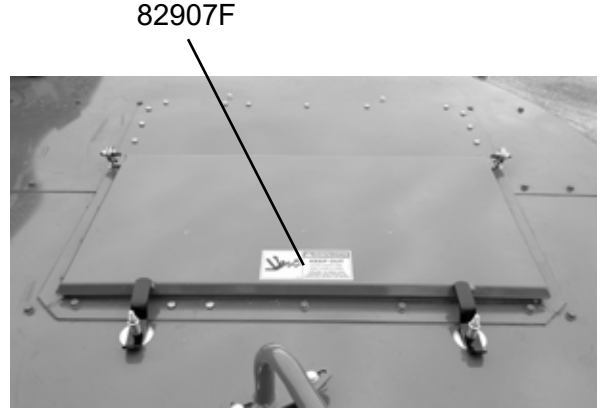
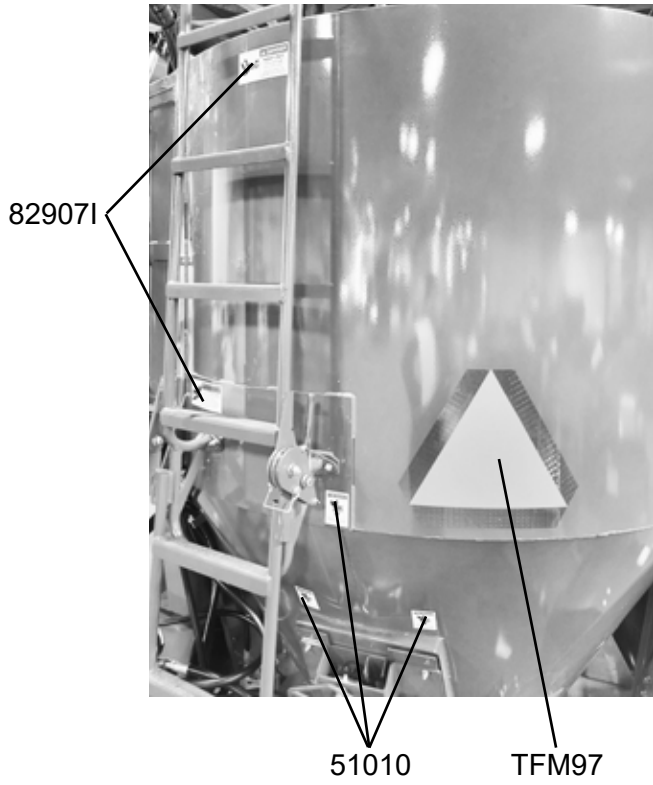

DECAL LOCATION

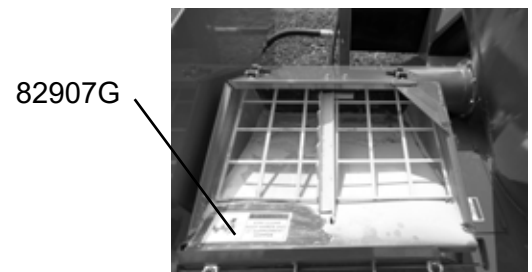
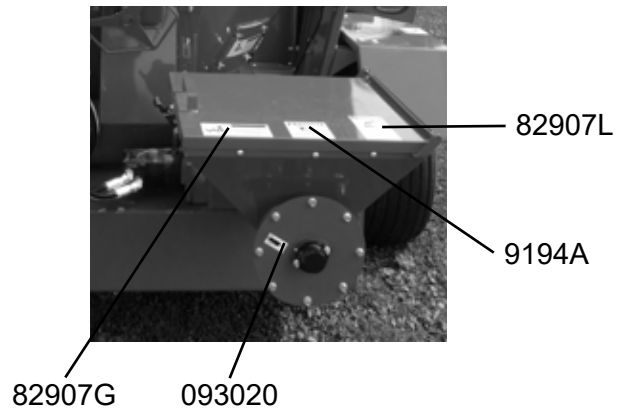
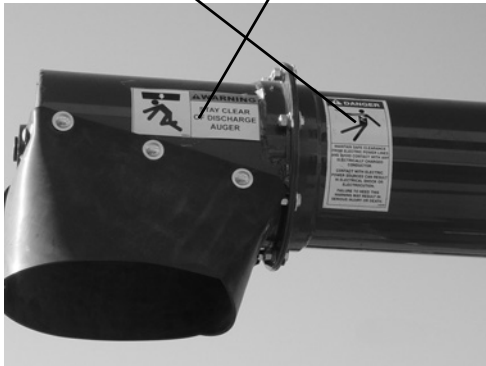
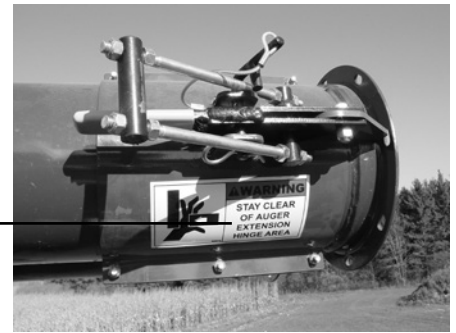
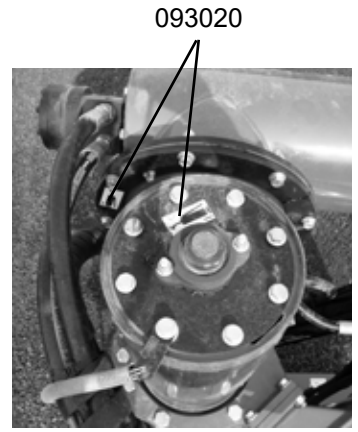
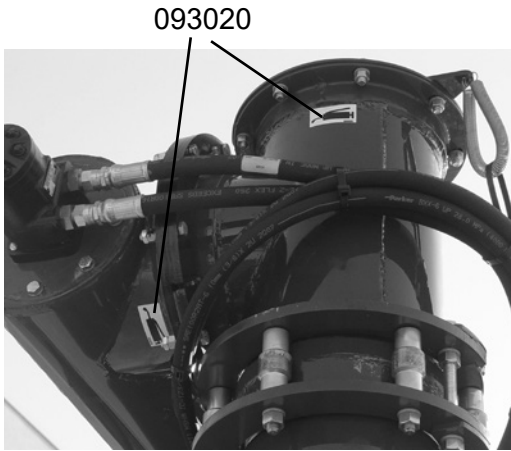

DECAL LOCATION

5696D 5696E 82907C

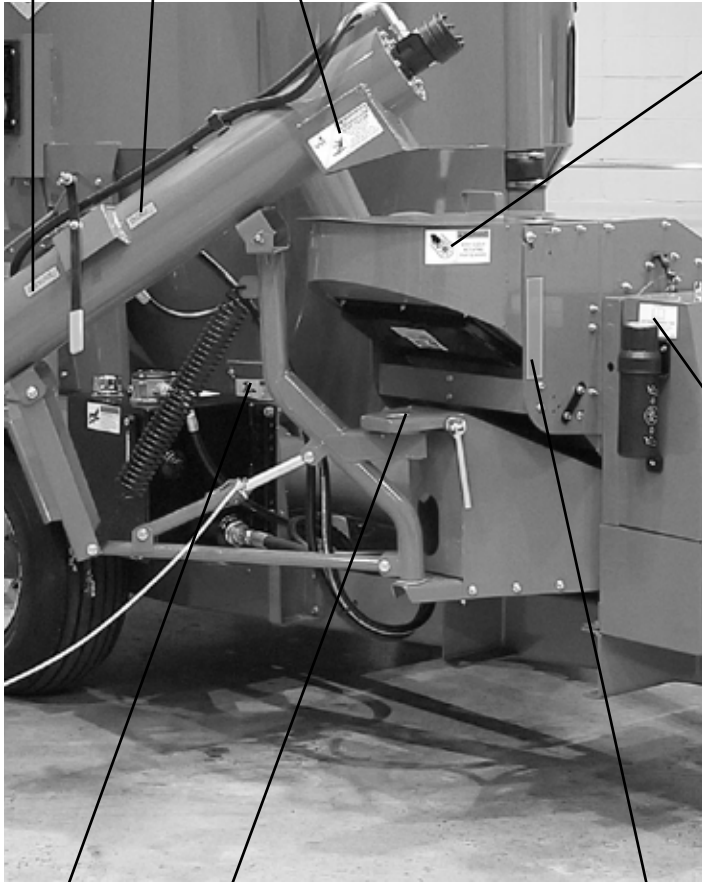

81209

093020

DCAMB

82907D
(Quantity 3)
(1) 82907D on
each side of
the hopper, &
(1) on the flap
in the inside

82907C



093366

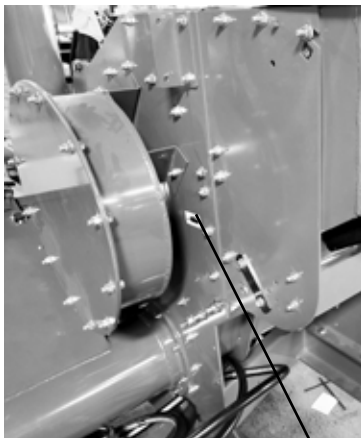

093020

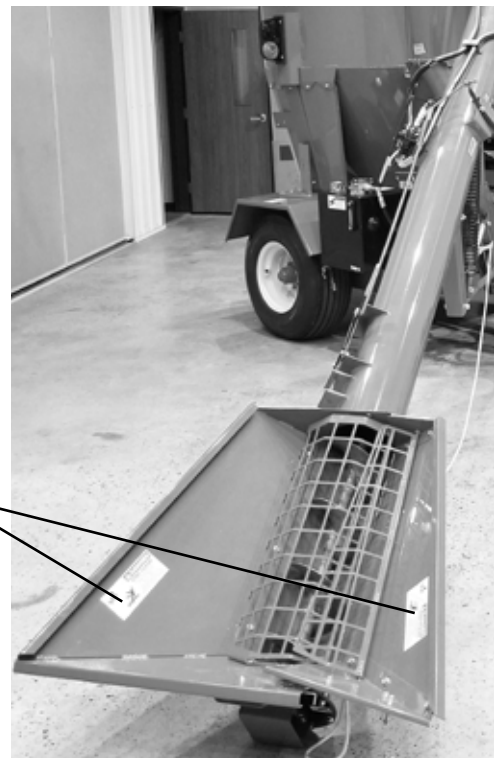

82907C

TROUBLESHOOTING

NOTE: This *Troubleshooting Chapter* presents problems, causes and suggested remedies beyond the extent of loose, worn or missing parts and it was developed with the understanding that the machine is in otherwise good operating condition.

MILL & MIXER DRIVE

PROBLEM	CAUSE	REMEDY
PTO Shaft vibrates excessively.	Improper tractor hook-up	Adjust hook-up.
	Tractor being operated at an angle.	Align tractor straightaway with Grinder-Mixer.
	PTO shaft bent.	Replace PTO shaft.
	PTO shaft bearings worn.	Replace bearings
Mill/Blower doesn't turn.	Mill Engaging Pin not engaged or improperly engaged.	Engage Pin.
	Mill/Blower drive belt slipping.	Adjust belt tension.
Mixing Auger doesn't turn.	Transmission shear bolt sheared.	Replace bolt and correct cause of bolt failure.
	Front drive chain disconnected.	Repair or replace chain.
	Transmission rear drive chain disconnected.	Repair or replace chain.
	Sprocket key sheared.	Replace key.
	Transmission gear key sheared.	Replace key.
	Broken shaft.	Replace shaft.
Transfer Auger doesn't turn.	Front drive chain is broken or disconnected.	Repair or replace chain.
	Transmission shear bolt sheared.	Replace bolt and correct cause of bolt failure.

TROUBLESHOOTING

MILL

PROBLEM	CAUSE	REMEDY
Decreased or low capacity	<p>Mill not operating at the recommended RPM speed.</p> <p>Mill loses speed as material enters it.</p> <p>Hammers worn</p> <p>Screen worn.</p> <p>Blower inlet plugged.</p>	<p>Adjust tractor throttle to proper RPM speed.</p> <p>Adjust Mill/Blower sheave alignment and/or drive belt tension.</p> <p>Flip/turn or replace hammers.</p> <p>Rotate or replace screen.</p> <p>Unplug.</p>
Excess vibration.	<p>Uneven flow of grain into the mill.</p> <p>Excess RPM.</p> <p>Mill bearings worn or defective.</p> <p>Flywheel bearings worn or improperly adjusted.</p> <p>Hammers missing or broken.</p> <p>Blower unbalanced.</p>	<p>Transfer grain into the mill as smoothly as possible.</p> <p>Operate at 540 RPM.</p> <p>Replace bearings.</p> <p>Replace and/or properly adjust bearings.</p> <p>Replace hammers.</p> <p>Remove, balance & replace.</p>
Excessive dust.	<p>Blower inlet plugged.</p> <p>Collector covered.</p>	<p>Check & unplug.</p> <p>Uncover collector while operating.</p>
Material not ground to desired size.	<p>Incorrect screen being used.</p> <p>Mill speed too high or low.</p>	<p>Change screen diameter to correct size.</p> <p>Adjust to correct RPM speed.</p>
Material will not flow through mill hopper.	<p>Mixer is sloped towards the feeding side.</p> <p>Material too damp.</p> <p>Material too light or bulky.</p>	<p>Reposition mixer on level ground.</p> <p>Adjust slope of intake hopper.</p> <p>Adjust slope of intake hopper.</p>

UNLOADING

PROBLEM	CAUSE	REMEDY
Tank won't unload or stops unloading.	Bridging in tank.	Shut-off mixer and tractor, break up bridging by probing through the access doors.
Tank unloads too slow.	Discharge door is not open all the way.	Open door up some more.

TROUBLESHOOTING

HYDRAULICS

Note: In troubleshooting a self-contained hydraulic system, it is necessary to isolate the pump from the hydraulic motors to determine which unit is malfunctioning. A worn pump or motor will both give the same system indication. Run a pressure and flow check on the pump first to make sure that it is performing within the operating specifications, then check the motor for the correct specifications. Oil flow must be checked at the rated PTO speed. Flow should be 9.2 GPM at 1000 PSI.

PROBLEM	CAUSE	REMEDY
Discharge augers do not turn.	On/Off control valve in off position. Pump defective. Hydraulic motor defective. Hydraulic pressure too low. Foreign object lodged in auger.	Turn On/Off control valve on. Replace pump. Replace or repair hydraulic motor. Check for restriction in hydraulic lines. Remove foreign object.
Difficult to engage or disengage On/Off control valve.	On/Off control valve defective.	Replace On/Off control valve.
Pump will not turn.	Belt out of grooves. Belt does not have proper tension. Pump defective. Return line blocked or restricted.	Realign sheaves and adjust belt tension. Replace idler tension spring or properly position idler. Check oil flow and replace pump if necessary. Remove blockage and replace oil and filter if dirty.
Pump squeals during start up.	Oil too heavy/cold. Oil level in reservoir too low.	Allow oil to warm up or switch to a recommended lighter oil. Add oil to bring between min/max indicator levels.
Augers operating slow.	Improper oil flow. Plugged oil filter. Hydraulic pump defective. Hydraulic motor defective. Oil too thin. Not enough oil flow to hydraulic pump.	Check pump output pressure as applicable. Replace filter. Replace hydraulic pump. Repair or replace hydraulic motor. Replace with heavier oil. Change oil filter, replace oil with new oil and fill to proper level.

TROUBLESHOOTING

HYDRAULICS

PROBLEM	CAUSE	REMEDY
Tank unloads slow.	<p>Insufficient oil flow to motors.</p> <p>Plugged oil filter.</p> <p>Hydraulic pump defective.</p> <p>Hydraulic motor defective.</p> <p>Oil too thin.</p> <p>Not enough oil flow to hydraulic pump.</p> <p>Loose connection to the motor.</p> <p>Belt slipping</p>	<p>Increase tractor RPM speed.</p> <p>Replace filter.</p> <p>Replace hydraulic pump.</p> <p>Repair or replace hydraulic motor.</p> <p>Replace with heavier oil.</p> <p>Change oil filter, replace oil with new oil and fill to proper level.</p> <p>Check and tighten connection.</p> <p>Check spring adjustment on pump tightener, replace belt.</p>
None of the motors operate.	<p>Pump not being driven.</p> <p>Discharge on/off valve control in off position.</p> <p>Hydraulic pump defective.</p> <p>Discharge auger On/Off control valve relief pressure set too low.</p>	<p>Check sheaves and belt for malfunction.</p> <p>Move to ON position.</p> <p>Replace hydraulic pump.</p> <p>Check pressure to valve, if pressure is low adjust to factory setting or replace if it will not adjust.</p>
Discharge auger On/Off control valve will not engage or disengage.	<p>On/Off control valve defective.</p>	<p>Replace On/Off control valve.</p>
Swinging Intake Auger (SIA) attachment will not operate.	<p>SIA variable speed control in the off position.</p> <p>SIA variable speed control valve relief pressure set too low.</p> <p>SIA Auger plugged.</p>	<p>Check mechanical linkage controls and open valve.</p> <p>Check pressure to valve, if pressure is low adjust to factory setting or replace if will not adjust.</p> <p>Remove obstruction.</p>
Auger in SIA turns in the wrong direction.	<p>Motor connections crossed.</p>	<p>Switch hose connections to change direction of motor rotation.</p>

TROUBLESHOOTING

HYDRAULICS

PROBLEM	CAUSE	REMEDY
Intake Auger turns too slow.	Excessive or wet grain.	The higher the moisture content and weight of the material that is being conveyed, the more power it takes. Adjust the variable speed control valve to allow more oil to the hydraulic motor.
	Not enough oil flow to hydraulic pump.	Change oil filter, replace oil with new oil and fill to proper level.
	Hydraulic pump defective.	Replace hydraulic pump.
	Hydraulic motor defective.	Repair or replace hydraulic motor.
	SIA relief valve pressure set too low.	Check pressure to valve, if pressure is low adjust to factory setting or replace if will not adjust.
	SIA auger partially plugged.	Remove plugging material.
	SIA pressure relief valve doesn't function properly.	Check pressure to valve, if it will not adjust to the factory setting, replace the valve.

H&S MFG. CO.

products approved

for the

FEMA

SEAL OF QUALITY

