

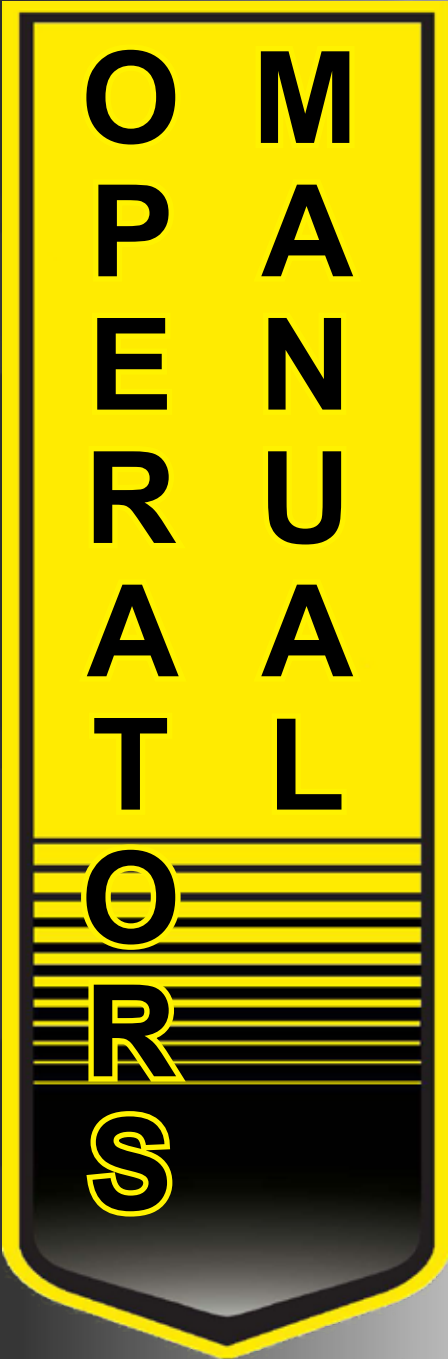

**4112/4114**  
**HI-CAPACITY**  
**RAKE**



**WARNING**

READ AND UNDERSTAND THIS MANUAL BEFORE OPERATING THIS EQUIPMENT. UNSAFE OPERATION OR MAINTENANCE OF THIS EQUIPMENT CAN RESULT IN SERIOUS INJURY OR DEATH.

4112 Starting Serial #321HC12026  
4114 Starting Serial #321HC14041

Part #76348

Rev. #03

HSMFG0123

**STRONG HERITAGE - STRONG PEOPLE - STRONGER FUTURE**

# **CONTENTS**

Warranty . . . . .	1
Manufacturer's Statement . . . . .	2
Warranty Registration Form . . . . .	3
Dealer Pre-Delivery Checklist . . . . .	5
Dealer Delivery Checklist . . . . .	7
Safety Information - Be Alert Symbol . . . . .	9
Explanation of Safety Signs . . . . .	10
Safety Decals . . . . .	11
Safety Information - Warning -Owner Must Read and Understand . . . . .	12
Cap Screw Torque Values . . . . .	13
Hydraulic Torque Specs. . . . .	14-15
Set-Up & Assembly . . . . .	16
Transporting . . . . .	17
Preparing for Operation . . . . .	18
Operation & Adjustments . . . . .	19-20
Optional Equipment . . . . .	21
Lubrication Guide . . . . .	22
Decal Location . . . . .	23-27
Troubleshooting . . . . .	28
Service Notes . . . . .	29-30
Specifications . . . . .	Inside Back Cover

## **H&S WARRANTY**

H&S Manufacturing Co., Inc. ("H&S") warrants this product to be free from defect in material and workmanship. Except as noted below, this warranty term is twelve (12) months on parts and labor, and twenty-four (24) months on parts only from the date of delivery of the product to the original purchaser by an authorized H&S dealer. Under this warranty, H&S will repair or replace, at its option, any covered part which is found to be defective in material or workmanship during the applicable warranty term. In no case will the covered repair cost of a part or parts exceed the replacement cost of that part. In no case, unless pre-authorized by H&S, will a component be replaced versus repaired unless the cost of labor and parts exceeds 75% of the cost of a new component. Warranty repairs must be performed by H&S or a dealer authorized by H&S to sell and/or service the product involved, and will use only new or remanufactured parts or components furnished by H&S. Any warranty repairs needing to be performed by a third party must be pre-authorized by H&S. Standard freight costs will be covered by H&S for any part used to make a warrantable repair, any form of express freight will not be covered unless pre-authorized by H&S. This warranty includes approved parts and labor to repair the product but does not include, and the purchaser is responsible for, any service call and/or transportation of the product to and from the dealer's place of business, for any costs related to travel, for any premium charged for overtime labor requested by the purchaser, and for any service work not directly related to any defect covered under this warranty.

This warranty includes only those components of the product manufactured by H&S. Warranty for any component not manufactured by H&S including, but not limited to, engines, batteries, tires, rims, hydraulic motors, pumps, etc. are covered by the warranty, if any, provided separately by their respective manufacturers. H&S reserves the right to request the return of any failed component.

This warranty in all its parts is extended solely to the original purchaser of the product, is terminated upon any subsequent transfer or sale from or by the original purchaser, and extends no third party benefits or rights whatsoever.

The warranty term for any product used in any for hire, rental fleet or rental application, is limited to six (6) months from the date of delivery of the product to the original purchaser by an authorized H&S dealer.

This warranty does not include: (1) Any product that has been altered or modified in ways not approved by H&S; (2) Depreciation or damage caused by normal wear, use for which the product was not designed, misuse, improper or insufficient maintenance, improper operation, accident or failure to follow the product Operator's Manual recommendations and product decal recommendations; (3) Normal maintenance parts and service; (4) Repairs made with parts other than those available from H&S or performed by anyone other than H&S or a dealer authorized by H&S to sell and/or service the product involved.

To secure warranty service the purchaser must report the product defect to a dealer authorized by H&S to sell and/or service the product involved within the applicable warranty term together with evidence of the warranty start date and make the product available to that dealer within a reasonable period of time.

For these warranty terms to be in effect the selling authorized H&S dealer and/or the customer must submit the warranty registration to H&S.

THERE ARE NO WARRANTIES WHICH EXTEND BEYOND THE DESCRIPTION ON THE FACE OF THIS WARRANTY. H&S and the companies affiliated with it make no warranties, representations, or promises, express or implied, as to the performance or freedom from defect of its products other than those set forth above and NO IMPLIED WARRANTY OF MERCHANTABILITY, FITNESS OR FITNESS FOR A PARTICULAR PURPOSE IS MADE. IN NO EVENT WILL THE DEALER, H&S OR ANY COMPANY AFFILIATED WITH H&S BE LIABLE FOR INCIDENTAL OR CONSEQUENTIAL DAMAGES. The ONLY REMEDY the purchaser has in connection with the breach of performance of any warranty on H&S products are those set forth above.

The selling dealer has no authority to make any representation or promise on behalf of H&S, or to modify the terms or limitations of this warranty in any way.

12/20/22

## **MANUFACTURER'S STATEMENT**

Congratulations on your selection of an H&S product. Your new H&S product has been manufactured of the finest quality materials and components. The performance you receive from your machine is largely dependent upon how well you read, understand this manual, and apply this knowledge. There is a right and a wrong way to do everything. Please do not assume that you know how to operate and maintain your machine before reading this manual carefully. Keep this manual available for ready reference. We are very appreciative of your patronage.

H&S reserves the right to make changes or add improvements to its products at any time without incurring any obligation to make such changes to products previously manufactured. Specifications, statements and descriptions of products contained in this publication are subject to change without prior notification.

## WARRANTY REGISTRATION

- Date of Purchase: \_\_\_\_\_
- Purchaser Name: \_\_\_\_\_
- Street Address: \_\_\_\_\_
- City: \_\_\_\_\_
- State: \_\_\_\_\_ Zip: \_\_\_\_\_
- Phone Number: \_\_\_\_\_
- E-mail Address: \_\_\_\_\_
- Product: \_\_\_\_\_
- Model Number: \_\_\_\_\_
- Serial Number: \_\_\_\_\_
- You have received the Operator's Manual for this product. Yes \_\_\_\_\_ No \_\_\_\_\_
- Interested in receiving the H&S E-mail Newsletter? Yes \_\_\_\_\_ No \_\_\_\_\_

- 
- Dealer Name: \_\_\_\_\_
  - Street Address: \_\_\_\_\_
  - City: \_\_\_\_\_
  - State: \_\_\_\_\_ Zip: \_\_\_\_\_
  - Signature: \_\_\_\_\_

- All fields must be filled out to ensure prompt notification of product and/or warranty updates.

**Please mail the completed WARRANTY REGISTRATION FORM to:  
H&S Manufacturing Co., Inc.  
2608 S. Hume Ave.  
Marshfield, WI 54449**

**Intentionally Left Blank**

# DEALER PRE-DELIVERY CHECKLIST

## AFTER COMPLETION, DEALER SHOULD REMOVE AND RETAIN FOR RECORDS

After the rake has been completely set up, check to be certain it is in correct operating order before delivering to the customer. The following is a list of points to inspect. Check off each item as you have made the proper adjustments and found the item operating satisfactorily.

- Rake was not damaged in shipment. Check for dents and loose or missing parts. Report damage immediately to H&S Manufacturing Co., Inc..
- Rake has been correctly assembled according to instructions in this manual. Wheel nuts and all other fasteners are tightly secured.
- All bolts and fasteners are tight.
- All grease fittings have been lubricated. See Lubrication Chapter of this manual for details.
- Hoses and fittings are properly attached and there are no visible leaks.
- All mechanisms are operating trouble free.
- Rake wheels touch ground in unison when lowered into position (Rake setting level).
- Wheels are properly mounted.
- Tires are inflated to correct pressure.
- Decals are in place and legible.

Model Number \_\_\_\_\_

Serial Number \_\_\_\_\_

Dealer's Name \_\_\_\_\_

Inspection Date \_\_\_\_\_

Signature of Pre-Delivery Inspector \_\_\_\_\_

(Remove Dealers File Copy At Perforation)

**INTENTIONALLY LEFT BLANK**



# DEALER DELIVERY CHECKLIST

## **AFTER COMPLETION, DEALER SHOULD REMOVE AND RETAIN FOR RECORDS**

This checklist that follows is an important reminder of valuable information that should be passed on to the customer at the time this rake is delivered.

Check off each item as you explain it to the customer.

This delivery checklist, when properly filled out and signed, assures the customer that the pre-delivery service was satisfactorily performed.

- Explain to the customer that the pre-delivery inspection was made.
- Explain to the customer all the safety precautions they must exercise when operating this unit.
- Explain raking and windrow width adjustments.
- Explain to customer that regular lubrication is required for proper operation and long life of machine.
- Show customer the lubrication section of Owner's Manual.
- Give the customer Owner's Manual and make sure they read and understand all operating and service instructions.
- Have the customer sign a completed "Warranty Registration" and mail it.

Date Delivered \_\_\_\_\_

Dealer's Name \_\_\_\_\_

By \_\_\_\_\_

Signature of Original Buyer \_\_\_\_\_

Note: Warranty is not valid until warranty card is completed and returned to H&S Mfg. Co., Inc.

**INTENTIONALLY LEFT BLANK**

**SAFETY INFORMATION**



**BE  
ALERT!**

**YOUR SAFETY  
IS INVOLVED.**

**THIS SYMBOL IS USED THROUGHOUT THIS BOOK WHENEVER YOUR PERSONAL SAFETY IS INVOLVED. TAKE TIME TO BE CAREFUL. REMEMBER: THE CAREFUL OPERATOR IS THE BEST OPERATOR. MOST ACCIDENTS ARE CAUSED BY HUMAN ERROR. CERTAIN PRECAUTIONS MUST BE OBSERVED TO PREVENT THE POSSIBILITY OF INJURY OR DAMAGE.**

**H&S MANUFACTURING CO., INC.**

# SAFETY INFORMATION

## RECOGNIZE SAFETY INFORMATION

This is the safety-alert symbol. When you see this symbol on your machine or in this manual, be alert to the potential for personal injury.

Follow recommended precautions and safe operating practices.



---

## UNDERSTAND SIGNAL WORDS

A signal word - DANGER, WARNING, or CAUTION - is used with the safety-alert symbol. DANGER identifies the most serious hazards.

Safety signs with signal word DANGER or WARNING are typically near specific hazards.

General precautions are listed on CAUTION safety signs.



**WARNING**



**CAUTION**



## FOLLOW SAFETY INSTRUCTIONS

Carefully read all safety messages in this manual, and all safety signs on your machine. Follow all recommended precautions and safe operating procedures.

Keep signs in good condition. Immediately replace any missing or damaged signs.

---

## OBSERVE MAXIMUM TRANSPORT SPEED

**The maximum transport speed for this implement is 32 km/h (20 mph).**

Some tractors are capable of operating at speeds that exceed the maximum transport speed of this implement. Regardless of the maximum speed capability of the tractor being used to tow this implement, do not exceed the implement's maximum transport speed.

Exceeding the implement's maximum transport speed can result in:

- \* Loss of control of the tractor/implement combination
- \* Reduced or no ability to stop during braking
- \* Implement tire failure
- \* Damage to the implement structure or its components

Use additional caution and reduce speed when towing under adverse surface conditions, when turning, and when on inclines.

Do not attempt transport if the fully loaded implement weighs more than 1.5 times the weight of the tractor.

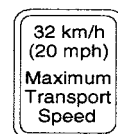

# SAFETY INFORMATION

**⚠ WARNING**

**HELP AVOID INJURY**

- READ & UNDERSTAND THE OPERATORS MANUAL PROVIDED WITH THIS MACHINE. IF MISPLACED CALL H & S MANUFACTURING AT 715-387-3414 WITH MODEL AND SERIAL NUMBER.
- UNDERSTAND ALL SAFETY WARNINGS AND FUNCTION OF CONTROLS.
- KEEP SAFETY DEVICES IN PLACE AND WORKING.
- KEEP YOURSELF AND OTHERS WELL CLEAR OF MOVING PARTS.
- DISCONNECT ALL POWER BEFORE SERVICING OR CLEANING THIS MACHINE.
- DO NOT EXCEED 20 MPH

72203A



**⚠ DANGER**

**STAY CLEAR OF RAKE WHEN OPENING OR CLOSING.**

**FAILURE TO HEED THIS WARNING MAY RESULT IN PERSONAL INJURY OR DEATH**

**KEEP CLOTHING, YOURSELF AND OTHERS WELL CLEAR.**

11694A



**⚠ WARNING**

**STAY CLEAR OF RAKE WHEN RAISING OR LOWERING RAKE WHEELS.**

**FAILURE TO HEED THIS WARNING MAY RESULT IN PERSONAL INJURY OR DEATH**

**KEEP CLOTHING, YOURSELF AND OTHERS WELL CLEAR**

2195



**⚠ WARNING**

**DO NOT GO NEAR LEAKS**

- High pressure oil easily punctures skin causing serious injury, gangrene or death.
- If injured, seek emergency medical help. Immediate surgery is required to remove oil.
- Do not use finger or skin to check for leaks.
- Lower load or relieve hydraulic pressure before loosening fittings.

11599

**TRACTOR:**

This operator's manual uses the term "Tractor" when identifying the power source.



# WARNING

**TO PREVENT SERIOUS INJURY OR DEATH**

BEFORE YOU ATTEMPT TO OPERATE THIS EQUIPMENT, READ AND STUDY THE FOLLOWING INFORMATION. IN ADDITION, MAKE SURE THAT EVERY INDIVIDUAL WHO OPERATES OR WORKS WITH THIS EQUIPMENT, WHETHER FAMILY MEMBER OR EMPLOYEE, IS FAMILIAR WITH THESE SAFETY PRECAUTIONS.

**DO NOT ALLOW PERSONNEL OTHER THAN THE QUALIFIED OPERATOR NEAR THE MACHINE.**

Stop the tractor engine, remove ignition key, and allow all mechanisms to stop before cleaning, working, or adjusting on machine.

**DO NOT** attempt to perform maintenance or repair with tractor running.

**DO NOT** step up on machine at any time.

**DO NOT** allow minors to operate or be near the machine.

Loose or floppy clothing should not be worn by the operator.

Stay clear of hydraulic lines, they may be under extreme pressure or heat.

Stay clear of rake when opening or closing main rake arm beams, or raising or lowering rake wheels.

For transport, always make sure that the hair pin at the rear of the lift pipes, and the transport lock bars with safety clip pins for main rake beam, are securely locked in place.

To reduce stress on rake arms, lift pipe, springs and spring brackets, reduce oil flow from tractor to lift cylinders whenever possible.

Be sure to raise rake wheels before opening or closing main rake beams.

H&S Manufacturing Co. always takes the operator and their safety into consideration and guards exposed moving parts for their protection. However, some areas cannot be guarded or shielded in order to assure proper operation. In addition, the operators manual and decals on the machine itself warn you of further danger and should be read and observed closely.

## Study The Above Safety Rules

**ATTENTION - BE ALERT - YOUR SAFETY IS INVOLVED**

# CAP SCREW TORQUE VALUES

The specifications below are the torque values for fasteners as it adheres to the SAE torque value standards. All fasteners should be torqued to the proper values found in the figures below unless otherwise specified by the engineering drawing.

- Lubed torque would be any fastener that has grease, liquid Loctite, oil, etc. on the threads.
- Dry torque would be any fastener which has threads that are clean and dry and do not have any liquid Loctite or grease on them.

## Hex Head Fasteners

The figure shown below shows how to determine what SAE grade a fastener is.

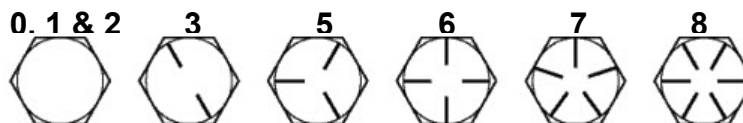

### SUGGESTED ASSEMBLY TORQUE VALUES

### WORKING TORQUE

	SAE GR. 2-6"		SAE GR. 5		SAE GR. 8		18-8 SS	316 SS	Brass	Silicon Bronze
Dia. & Thrds. per inch	Dry Ft. Lbs.	Lube Ft. Lbs.	Dry Ft. Lbs.	Lube Ft. Lbs.	Dry Ft. Lbs.	Lube Ft. Lbs.	Inch Lbs.	Inch Lbs.	Inch Lbs.	Inch Lbs.
1/4-20	5.5	4.2	8	6.3	12	9	75.2	78.8	61.5	68.6
1/4-28	6.3	4.7	10	7.2	14	10	94.0	99.0	77.0	87.0
5/16-20	11	8	17	13	24	18	132	138	107	123
5/16-28	12	9	19	14	27	20	142	147	116	131
3/8-16	20	15	30	23	45	35	236	247	192	219
3/8-24	23	17	35	25	50	35	259	271	212	240
7/16-14	32	24	50	35	70	50	376	393	317	349
7/16-20	36	27	55	40	80	60	400	418	327	371
1/2-13	50	35	75	55	110	80	517	542	422	480
1/2-20	55	40	85	65	120	90	541	565	443	502
9/16-12	70	55	110	80	150	110	682	713	558	632
9/16-18	80	60	120	90	170	130	752	787	615	697
5/8-11	100	75	150	110	210	160	1110	1160	907	1030
5/8-18	110	85	170	130	240	180	1244	1301	1016	1154
3/4-10	175	130	260	200	380	280	1530	1582	1249	1416
3/4-16	200	140	300	220	420	310	1490	1558	1220	1382
7/8-9	170	125	430	320	600	450	2328	2430	1905	2140
7/8-14	180	140	470	350	670	500	2318	2420	1895	2130
1-8	250	190	640	480	910	680	3440	3595	2815	3185
1-14	280	210	720	540	1020	760	3110	3250	2545	2885

# HYDRAULIC FITTING TORQUE SPECIFICATIONS

Tapered Pipe Thread Size - Assembly turns from Finger Tight (TFFT) for Tapered Threads		TFFT
BSPT (Uncommon)	NPTF (Common)	
1/8-28	1/8-27	2 - 3
1/4-19	1/4-18	2 - 3
3/8-19	3/8-18	2 - 3
1/2-14	1/2-14	2 - 3
3/4-14	3/4-14	2 - 3
1-11	1-11 1/2	1.5 - 2.5
1 1/4-11	1 1/4-11 1/2	1.5 - 2.5
1 1/2-11	1 1/2-11 1/2	1.5 - 2.5
2-11	2-11 1/2	1.5 - 2.5



ORB - SAE J1926 Straight Thread Port Assembly Torques													
		Assembly Torque (+10% -0) **If fitting is being torqued into aluminum or brass, subtract 35% from standard torque value**											
		Non-Adjustable				Adjustable				Plugs			
		ORFS		JIC NPT		ORFS		JIC		Hollow Hex		Hex Head	
Dash Size	SAE Size (UN/UNF)	Ft. lbs. (In. lbs.)	Into Alum. Or Brass Ft. lbs. (in. lbs.)	Ft. lbs. (In. lbs.)	Into Alum. Or Brass Ft. lbs. (in. lbs.)	Ft. lbs. (In. lbs.)	Into Alum. Or Brass Ft. lbs. (in. lbs.)	Ft. lbs. (In. lbs.)	Into Alum. Or Brass Ft. lbs. (in. lbs.)	Ft. lbs. (In. lbs.)	Into Alum. Or Brass Ft. lbs. (in. lbs.)	Ft. lbs. (In. lbs.)	Into Alum. Or Brass Ft. lbs. (in. lbs.)
2	5/16-24	-	-	(85)	(55)	-	-	(60)	(39)	(30)	(19.5)	(85)	(55)
3	3/8-24	-	-	(155)	(101)	-	-	(100)	(65)	(55)	(36)	(155)	(101)
4	7/16-20	(310)	(201.5)	(260)	(169)	(180)	(117)	(180)	(117)	(120)	(78)	(260)	(169)
5	1/2-20	(360)	(234)	(280)	(182)	(360)	(234)	(250)	(162.5)	(170)	(110.5)	(280)	(182)
6	9/16-18	(420)	(283)	(350)	(227.5)	(420)	(273)	(350)	(227.5)	(410)	(266.5)	(350)	(175)
8	3/4-16	60	39	(620)	(403)	60	39	(620)	(217)	60	39	(620)	(403)
10	7/8-14	100	65	85	55	100	65	85	55.25	100	65	85	55
12	1 1/16-12	135	88	135	88	135	88	135	88	135	88	135	88
14	1 3/16-12	175	114	175	114	175	114	175	114	175	114	175	114
16	1 5/16-12	200	130	200	130	200	130	200	130	200	130	200	130
20	1 5/8-12	250	162.5	250	162.5	250	162.5	250	162.5	250	162.5	250	162.5
24	1 7/8-12	305	198	305	198	305	198	305	198	305	198	305	198
32	2 1/2-12	375	244	375	244	375	244	375	244	375	244	375	244



# HYDRAULIC FITTING TORQUE SPECIFICATIONS

## Code 61 and 62 Flange Recommended Bolt Torques

### Steps to Properly Assemble the Flange Port Clamping Bolts:

1. Inspect components to ensure that male and female port threads and sealing surfaces are free of burrs, nicks and scratches, or any foreign material.
2. Lubricate the O-ring
3. Position flange and clamp halves
4. Place lock washers on bolts and insert through clamp halves
5. Hand tighten bolts.
6. Torque bolts in diagonal sequence in small increments to the appropriate torque level \*\*refer to the table below.

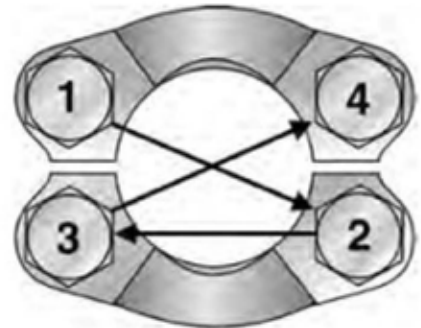

*Flange Bolt Tightening Sequence*

Code 61						Code 62					
Dash Size	Flange Size	Inch Bolt (SAE J518)	Torque ft. lbs.	Metric Bolt (ISO 6162)	Torque N-m	Dash Size	Flange Size	Inch Bolt (SAE J518)	Torque ft. lbs.	Metric Bolt (ISO 6162)	Torque N-m
8	1/2	5/16-18	17 ± 2	M8	24	8	1/2	5/16-18	17 ± 2	M8	24
12	3/4	3/8-16	31	M10	50	12	3/4	3/8-16	31	M10	50
16	1	3/8-16	31 ± 4.5	M10	50	16	1	7/16-14	52	M12	92
20	1-1/4	7/16-14	52	M12	92	20	1-1/4	1/2-13	77	M14	130
24	1-1/2	1/2-13	77	M12	92	24	1-1/2	5/8-11	155	M16	210
32	2	1/2-13	77	M12	92	32	2	3/4-10	265	M20	400
40	2-1/2	1/2-13	77	M12	92						
48	3	5/8-11	155	M16	210						
56	3-1/2	5/8-11	155	M16	210						
64	4	5/8-11	155	M16	210						
80	5	5/8-11	155	M16	210						

<b>37° Flare (JIC) Assembly Torques and FFWR</b>					
SAE Dash Size	Thread Size	Assembly Torque (+10%-0)		Tube Connection FFWR	Swivel Nut or Hose Connection FFWR
		In. lb.	ft. lb.		
-2	5/16-24	35	3	-	-
-3	3/8-24	65	5	-	-
-4	7/16-20	155	13	2 1/2	2
-5	1/2-20	165	14	2	2
-6	9/16-18	265	22	2	1 1/2
-8	5/8-16	505	42	2	1 1/2
-10	7/8-14	720	60	1 1/2	1 1/2
-12	1 1/16-12	1000	84	1 1/2	1 1/4
-14	1 3/16-12	1200	100	1 1/2	1 1/4
-16	1 5/16-12	1415	118	1 1/2	1
-20	1 5/8-12	2015	168	1	1
-24	1 7/8-12	2340	195	1	1
-32	2 1/2-12	3180	265	1	1
-40	3-12	-	-	1	1

# SET-UP & ASSEMBLY

**NOTE:** Determine right or left side of the wheel rake by viewing it from the rear. If instructions or parts lists call for hardened bolts, refer to Cap Screw Torque Values chart.

1. Assemble the rake or check the rake for proper assembly and adjustment. Make sure that all bolts are tightened.
2. Attach the wheels with tires, using the lug nuts furnished and torque the mounting hardware to 95 ft./lbs. of torque. Check wheel bolts periodically thereafter.
3. Check tires and inflate to the recommended pressure. (6.70 x 15 to 36 pounds.)
4. Lubricate the rake completely (See Lubrication Chapter in this Manual).
5. Tooth bolts must be torqued to 40 ft./lbs. to help prevent excessive tooth breakage.  
**Re-torque rake tooth bolts after the first 100 acres. Check periodically thereafter.**

## BF12HC ONLY

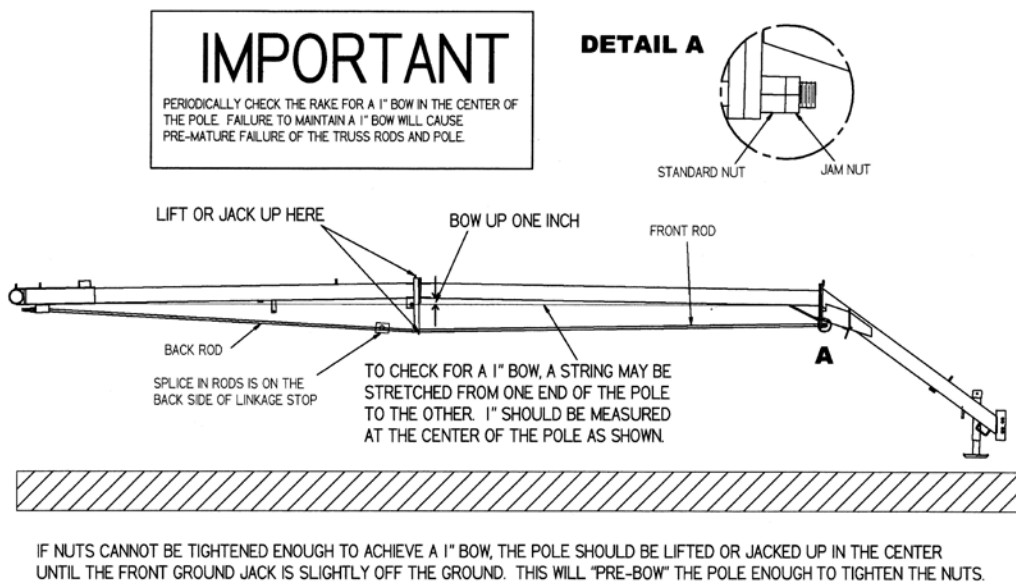

# **TRANSPORTING**

## **TRANSPORT LOCKS**

### **Rake Beam Locks**

Transport locks are mounted to the front of the pole. (A) Shows the rake locked into transport position. (B) Shows the transport locks in the convenient storage position, to be used when in the raking mode.

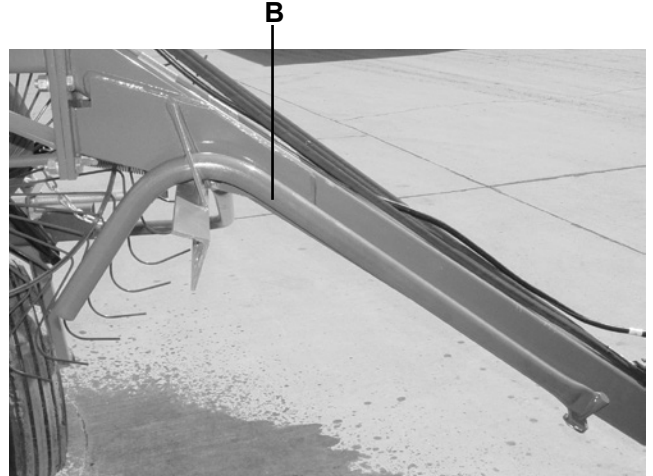
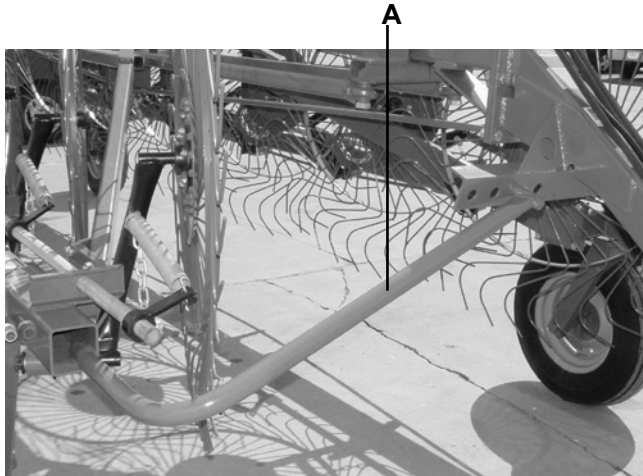

### **Rake Wheel Locks**

Located at the rear of the lift pipe, is a hair pin which is used to secure the rake wheels in the up position for transport (C). When in the down, or raking position, place the locking hair pin in the convenient storage position as shown (D).

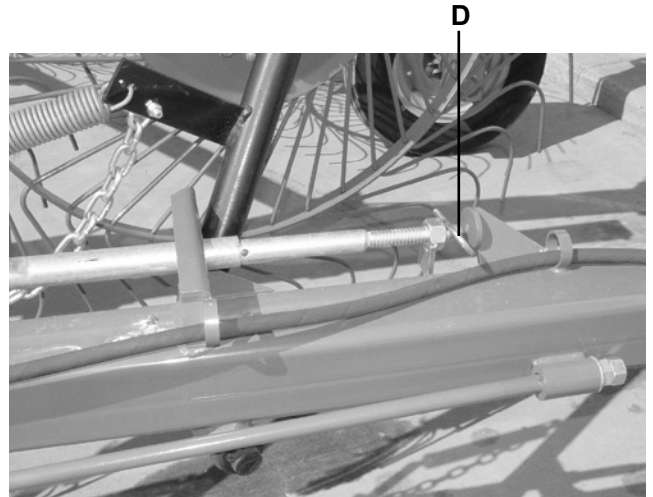
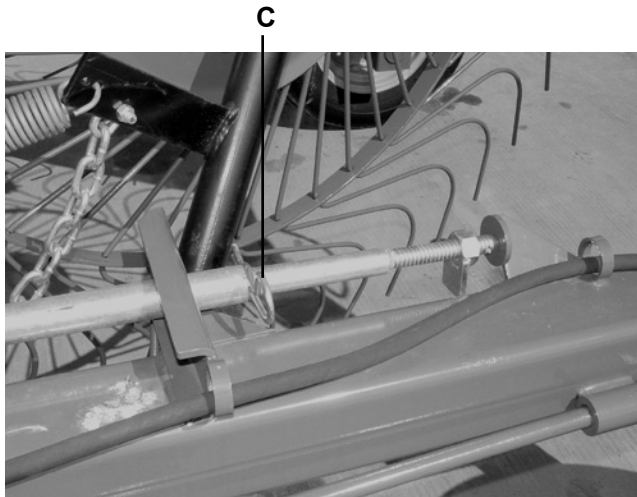

## **TOWING ON HIGHWAY**

Follow state and local regulations when towing farm equipment on public highways. Never tow the rake on a public highway at a speed greater than 20 mph (32 kph).

## **REFLECTORS**

Red and Amber reflective safety decals are on the rake for safety. Refer to the [Decal Placement Chapter](#) for location.

## PREPARING FOR OPERATION

1. Adjust the tractor hitch (13 to 17 inches above ground) and attach rake to tractor with a **hitch pin with a safety locking device**.

2. There are ten different positions to adjust the hitch on your new rake. Hitch should be adjusted so main frame of the rake is level or parallel to the ground.

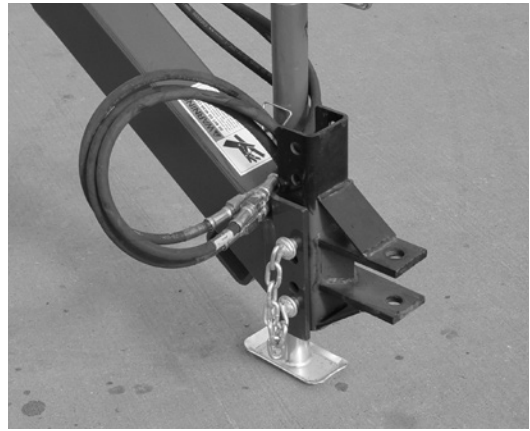

3. Remove weight from lift jack. Remove jack from pipe and place on convenient storage mount located on the front top of pole.

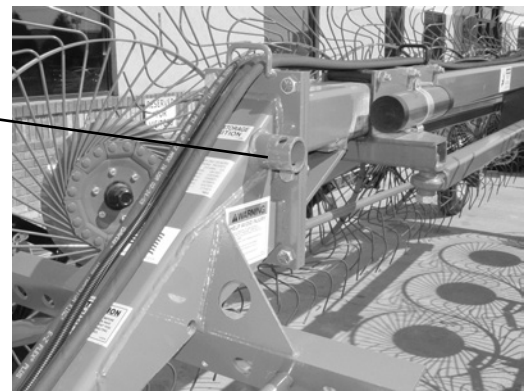

4. Connect the hydraulic hoses for raising and lowering rake wheels from rake to a double acting valve on the tractor.

5. Connect the hydraulic hoses for opening and closing the rake to a double acting valve on the tractor.

6. Connect the 7-pin electrical connector to tractor (If equipped with optional lighting).

# OPERATION & ADJUSTMENTS

## EMERGENCY SHUTDOWN

Stop the tractor engine, remove ignition key, and allow all mechanisms to stop before cleaning or working on the machine.

## RAKING WIDTH

Raking width is determined by setting the spring loaded stop, located above the rear pole section as shown.



## GROUND PRESSURE

Rake wheel to ground pressure is adjusted by turning the threaded rod while the rake wheels are in the raised position. This allows the tab nut to stay stationary while the threaded rod rotates, thus decreasing pressure, or increasing pressure. The further forward that the nut is on the threaded rod, the lesser the amount of rake wheel ground pressure. The further back that the nut is on the threaded rod, the greater the amount of rake wheel ground pressure.

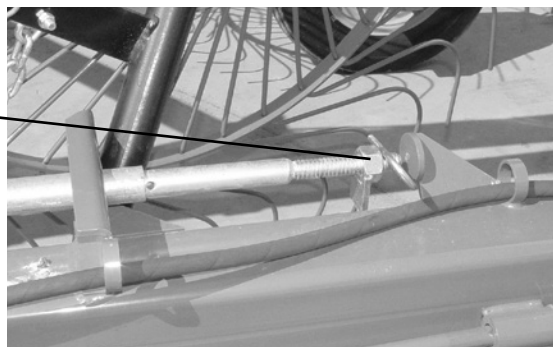

## WINDROW WIDTH

Windrow width is adjustable from 38" to 58" on the 12-wheel and 46" to 66" on the 14/16 wheel rakes. Adjustment is made by turning crank, located on the left of the rear of the rake as shown.



# OPERATION & ADJUSTMENTS

## GAUGE WHEELS

Outboard gauge wheels are located on the forward section of each rake beam. These gauge wheels support the rake beams to allow the rake wheels to better follow the contour of the ground. Located on the gauge wheel pivot spindle is an adjustable brake assembly. Adjust brake by tightening bolt. The brake should have enough tension to prevent zig-zag motion, but still allow the wheel to pivot when making corners.



Adjustable  
Brake  
Assembly

# **OPTIONAL EQUIPMENT**

## **OPTIONAL CENTER KICKER WHEEL**

An optional center kicker wheel assembly is available for the Rake. If the hay is laying out flat, these extra wheels allow you to raise the hay laying in the center of the rake out of the stubble for faster drying, and easier pick-up. A separate cylinder controls the kicker wheel assembly. It raises and lowers with the rake wheels.

### **2-Wheel Center Kicker Wheel**

To engage center kicker wheels, hydraulically open rake to desired raking width. Remove Locking Pin (C), swivel kicker wheel assembly to the desired raking angle. Re-insert the locking pin. Next, remove Locking Pin (A) from transport lock position, and insert into convenient Storage Position (B). Lower rake wheels to begin raking.

To return to transport position, PRIOR TO CLOSING RAKE, raise rake wheels. (This will also raise the center kicker wheel assembly). Remove Locking Pin (C), Swivel kicker wheel assembly so that it is in line with the hitch pole. Re-insert Pin (C). Remove locking pin from Storage Position (B) and insert to lock the unit into the up or Transport Position (A). Rake beams may now be closed for transport.

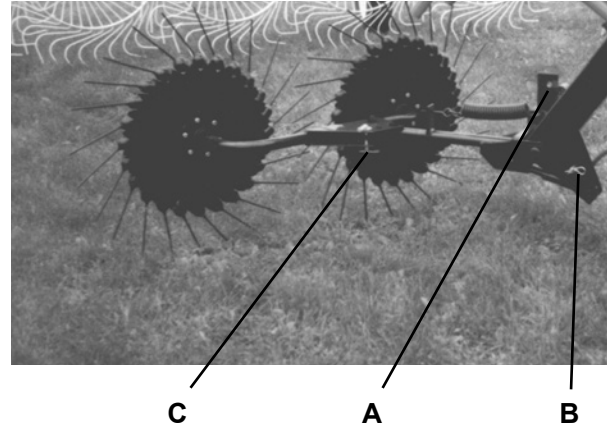

## **MISC. OPTIONS**

- > **Rear Tandem for 4112**
- > **Highway Lighting Kit**
- > **Wind Panel Kit**
- > **Safety Chain**
- > **2-Wheel Add-On Kit for converting a 14-wheel rake to a 16-wheel rake**
- > **Rake Beam Support Wheels**

# LUBRICATION GUIDE

## GENERAL INFORMATION

**IMPORTANT:** Catch and dispose of fluid per local waste disposal regulations whenever service is performed on hydraulic components, valves, cylinders, hoses, etc.

## GREASE FITTINGS

There are numerous grease fittings on the rake. If equipped with a center kicker wheel, there will be one more on the pivot point. Lubricating properly and often enough will prolong the life of your rake. Grease daily during normal use and **before and after storage and after power washing**. Use a good grade of high-quality grease. Make sure that grease comes out around the shaft on sleeve-type bearings. Wipe off excessive grease to prevent accumulation of chaff or grit around the bearing.

### Location

Listed and shown are the description of location and number of grease fittings.

- A. (2) Top Opening Arm Front Pivot
- B. (2) One on Each Gauge Wheel
- C. (2) One on Each Lift Cylinder Mounting Bracket
- D. (2) One on Each Rake Beam Pivot
- E. (6) Top Rear Windrow Width Adjustment
- F. (5) Top Opening Arm Rear Pivot
- G. (1) Center Kicker Wheel Pivots (If Equipped)
- (4) One on Each Transport Wheel Hub (4 on BF12HC and 6 on BF14HC)
- (12) One on Each Rake Arm Hub (BF12HC Only)

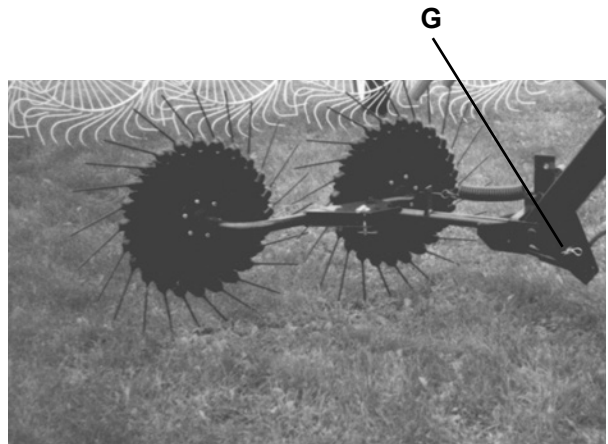
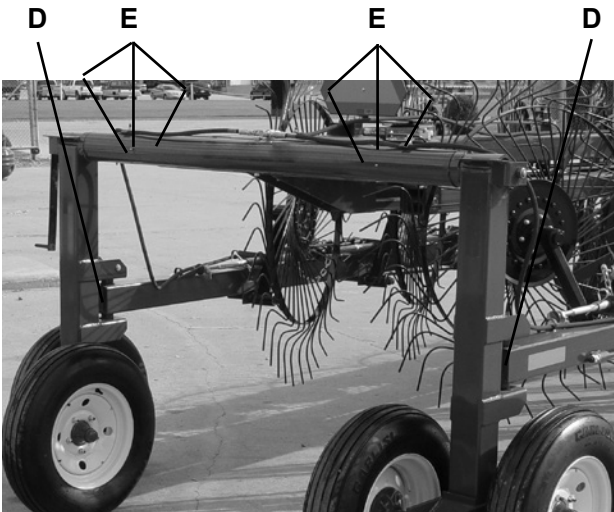
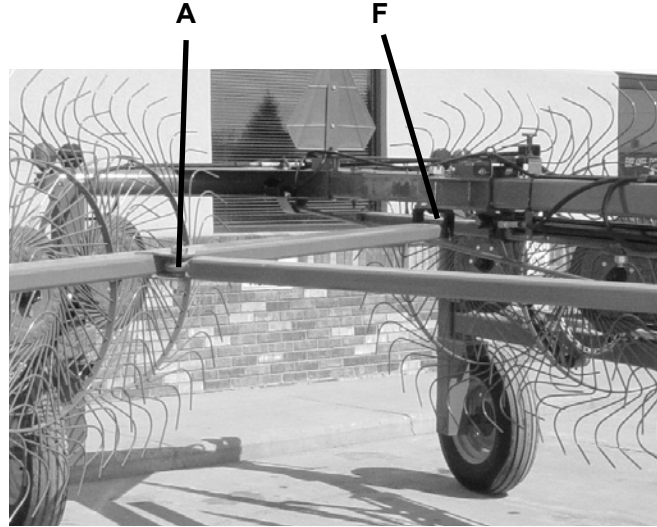
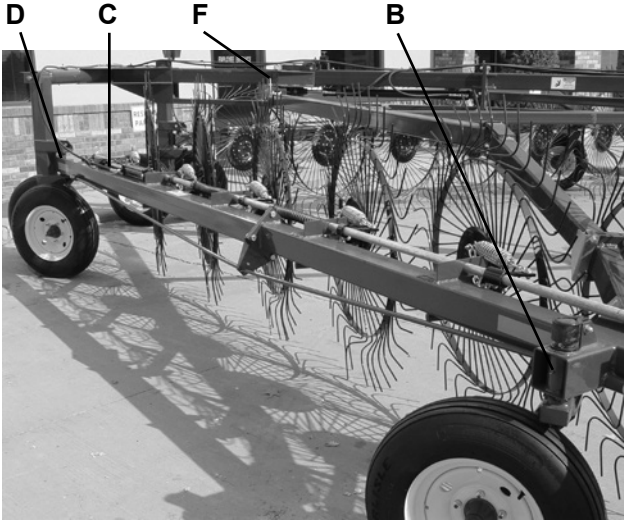



## DECAL LOCATION

Your rake was manufactured with operator safety in mind. Located on the rake are various decals to aid in operation and warn of danger or caution areas. Pay close attention to all the decals.



**DO NOT REMOVE ANY OF THESE DECALS. IF THE DECALS ARE LOST, DAMAGED, OR IF THE *Hi-CAPACITY* RAKE IS REPAINTED, REPLACE THE DECALS. REMEMBER: DECALS ARE FOR YOUR PROTECTION AND INFORMATION.**

Listed below are the decals on your rake. These decals may be ordered individually by part number or by ordering the complete set.

<u>PART</u>	<u>QTY</u>	<u>DESCRIPTION</u>
311	1	Patent Numbers
2195	4	WARNING - Stay Clear of Rak
11102	1	ATTENTION: Adjust Flange Nut <b>(4112 Only)</b>
11599	3	WARNING - Do Not Go Near Leaks
11694A	4/12 - 6/14	DANGER - Stay Clear of Rake
11694B	2	DANGER - Stay Clear <b>(4112 Only)</b>
12197A	1	Attention: Raise Rake Wheels
54033	1	Made in the USA
71188B	1	Jack Storage Position
71271	2	Model 4112
71272	2	Model 4114
71275	2	H&S HI-Capacity Rake Decal Left and Rear 4112/4114
71277	1	H&S HI-Capacity Rake Decal Right 4112/4114
72203A	1	WARNING - Help Avoid Injury
84044	1	FEMA
84045	1	H&S Since 1967
093020	17	Grease Zerk
BFR723	1	SMV Sign Kit
DCAMB	4	Amber Reflector - 2" x 9" (2 On Each Main Rake Beam)
DCAMB1	1	Amber Reflector - 3-1/4" x 5-5/8"
DCRED	2	Red Reflectors

# DECAL LOCATION

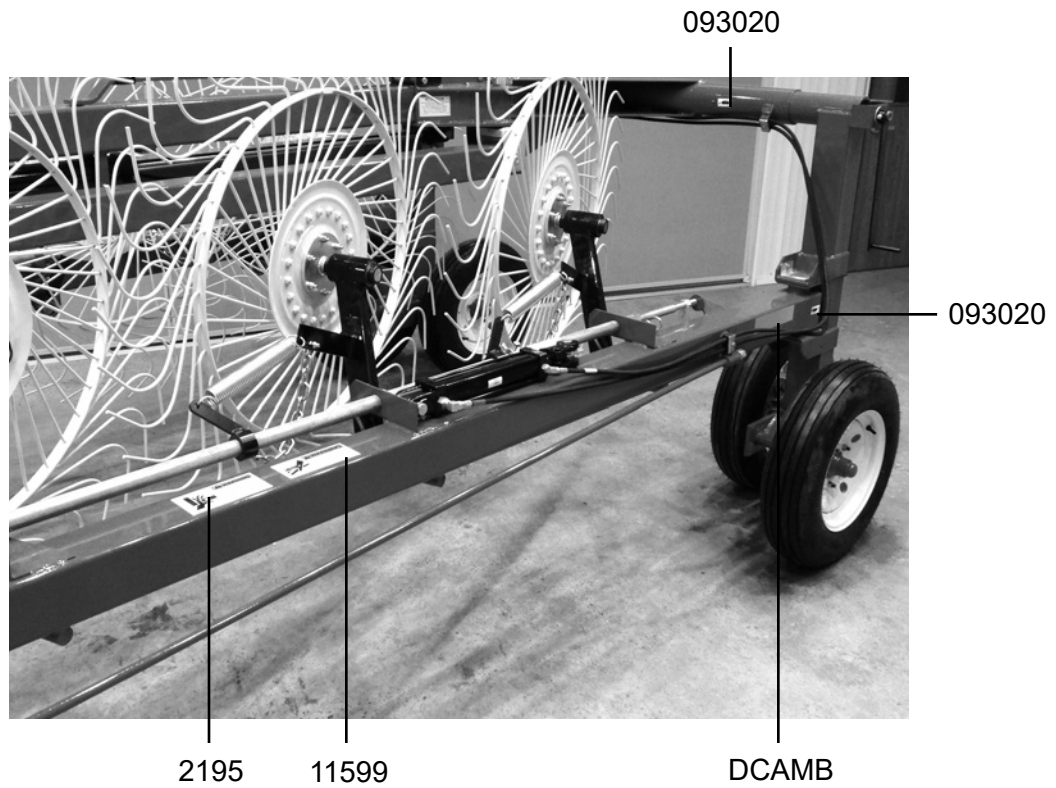

# DECAL LOCATION

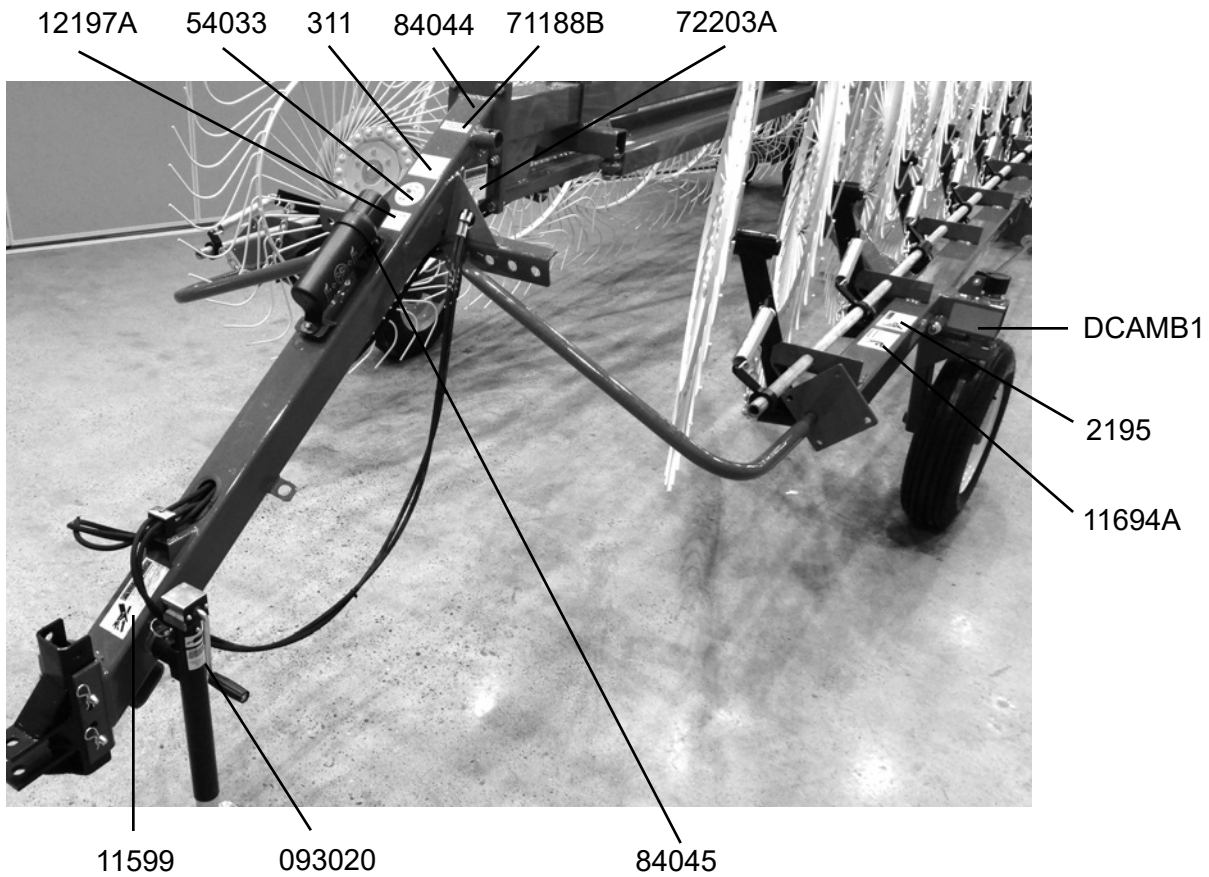
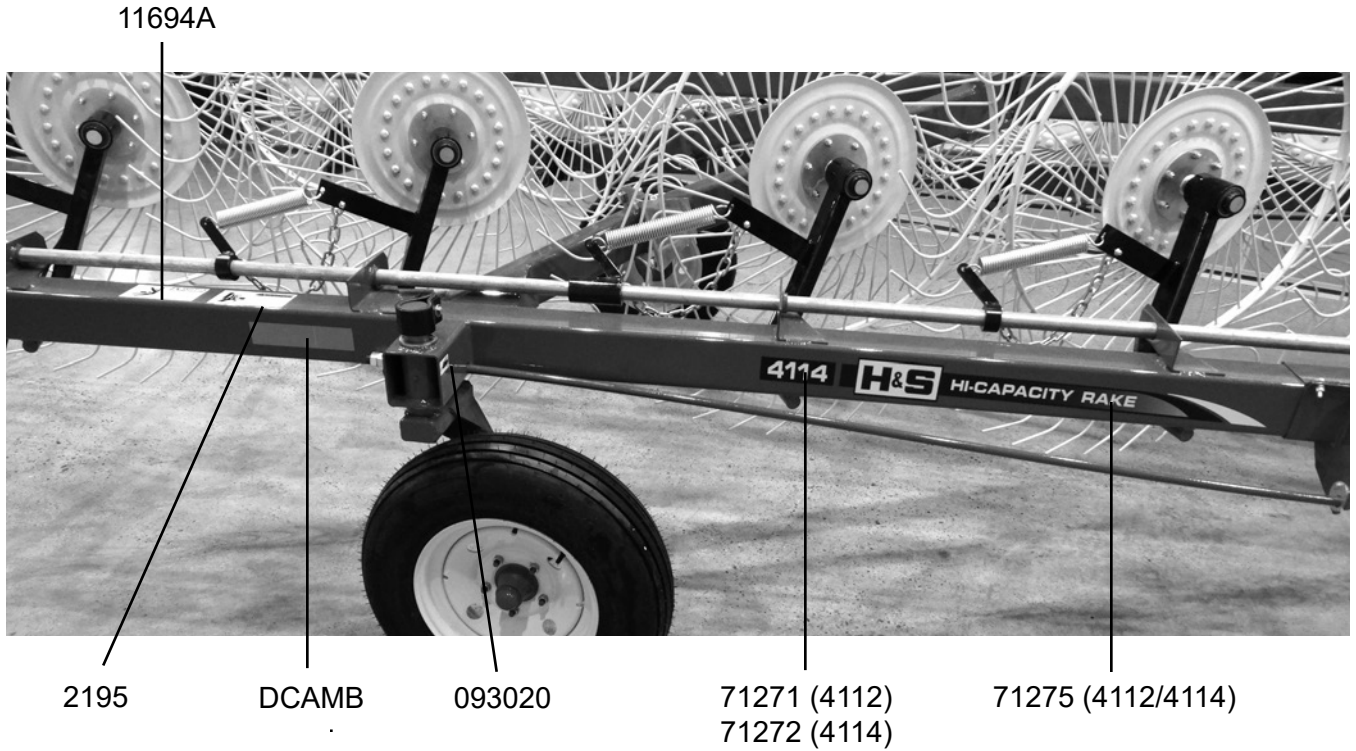

# DECAL LOCATION

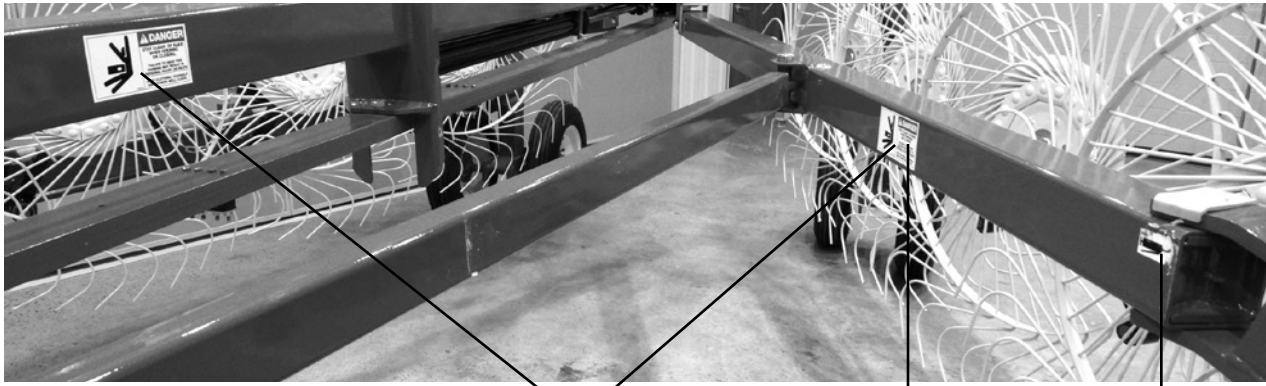

11694A

11694B  
4112 ONLY

093020



093020

11694B  
4112 ONLY

11694A

11102  
(4112 ONLY)

093020

71275

093020

DCRED



DCRED

# DECAL LOCATION



71277 (4112/4114)

71271 (4112)  
71272 (4114)

093020

DCAMB

2195

11694A

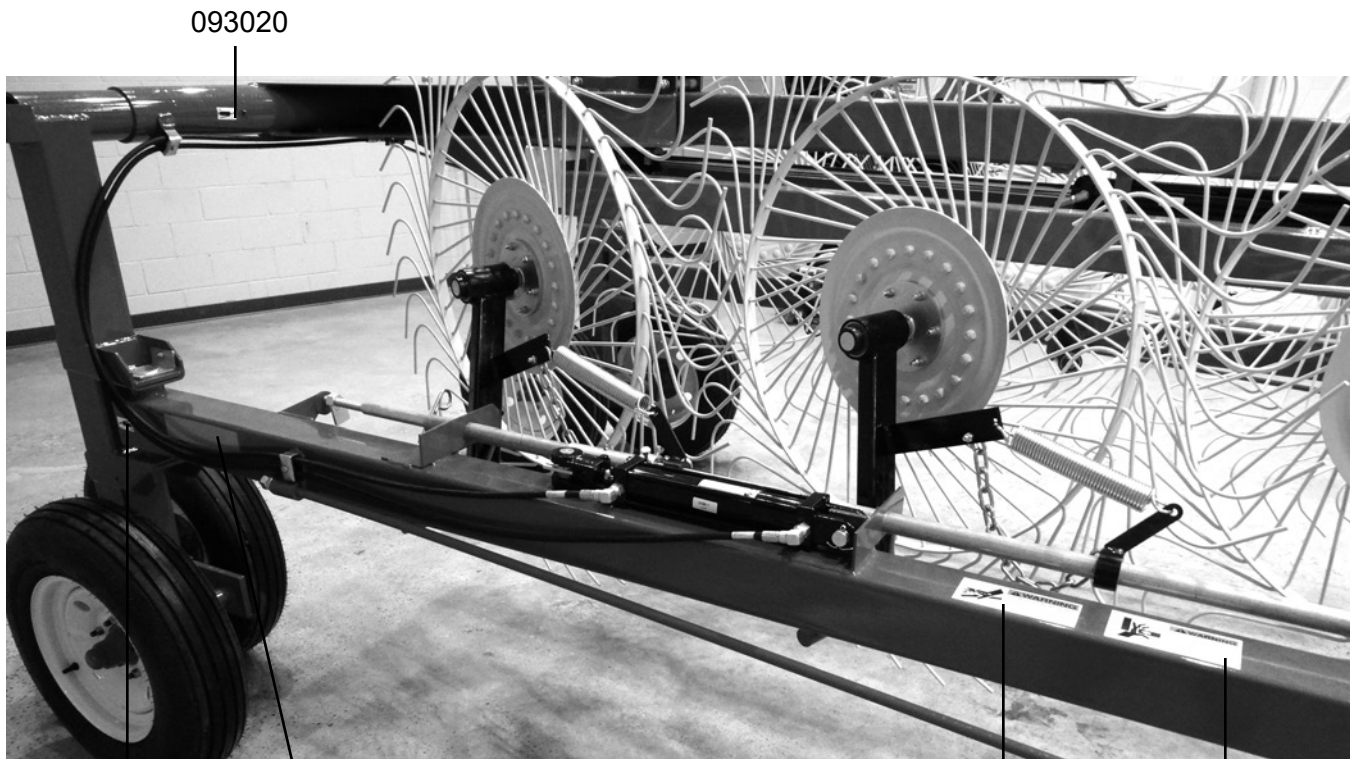

093020

093020

DCAMB

11599

2195

# TROUBLESHOOTING



**WARNING:**

**MAKE SURE THAT THE TRACTOR IS SHUT OFF AND THE RAKE CANNOT MOVE BEFORE SERVICING THE 12/14 *Hi-CAPACITY* RAKE. MAINTENANCE AND REPAIR SERVICE WORK TO BE PERFORMED BY A QUALIFIED SERVICE PERSON ONLY.**

<u>TROUBLE</u>	<u>POSSIBLE CAUSE</u>	<u>POSSIBLE REMEDY</u>
Rake Will Not Open	Rake Locked In Transport	Remove Transport Locks And Return To Storage Position
	Hydraulic Couplers Not Coupled To Tractor Properly	Couple Hydraulic Hoses To Tractor
	Hydraulic Hoses Mixed Up With Rake Wheel Lift Hose	Sort Hoses Correctly And Re-couple To Tractor
	Tractor Hydraulics Do Not Have Sufficient Pressure	Tractor Should Have At Least 1500 PSI To Operate Rake NOTE: Always Drive Forward Slowly And Open Rake At The Same Time
Rake Will Not Close	Tractor Hydraulics Do Not Have Sufficient Pressure	Tractor Should Have At Least 1500 PSI To Operate Rake NOTE: Always Drive Forward Slowly And Open Rake At The Same Time
Rake Wheels Will Not Lower	Rake Wheels Locked In Transport	Remove Hair Pin From Adjuster, Place In Storage Position
	Lift Pipe Binding	Check Lift Pipe Make Sure It Is Free Moving
	Tractor Hydraulics Not Able To Operate Single Acting Cylinder	Consult Your Tractor Dealer on How This Can Be Accomplished







## **SPECIFICATIONS**

	<u><b>12</b></u>	<u><b>14</b></u>	<u><b>16</b></u>
Number of Wheels	12	14	16
Wheel Diameter	55"	55"	55"
Teeth per Wheel	40	40	40
Tooth Diameter	7 MM	7 MM	7 MM
Transport Width	8'6"	8'6"	8'6"
Transport Length	24'6"	27'3"	30'3"
Windrow Width Adjustment	38"-58"	46"-66"	46"-66"
Raking Width	Up to 24' Hyd. Set	Up to 28' Hyd. Set.	Up to 32' Hyd. Set
Raking Wheel Hubs	Tapered Bearings	Ball Bearings	Ball Bearings
Wing Flex	3' Up or Down	3' Up or Down	3' Up or Down
Number of Transport Wheels	4	6	6
Hitch Jack	Standard	Standard	Standard
Center Kicker Wheels	Optional	Optional	Optional
Lights	Optional	Optional	Optional
Rear Transport Wheels	15"	15"	15"
Front Transport Wheels	15"	15"	15"
Weight	3500 Lbs.	3800 Lbs.	4200 Lbs.

# **H&S MFG. CO.**

products approved

for the

## **FEMA SEAL OF QUALITY**



Manufactured By:

**H&S MANUFACTURING CO., INC.**

2608 S. HUME AVE. MARSHFIELD, WI 54449

(715) 387-3414 | [hsmfgco.com](http://hsmfgco.com)

