

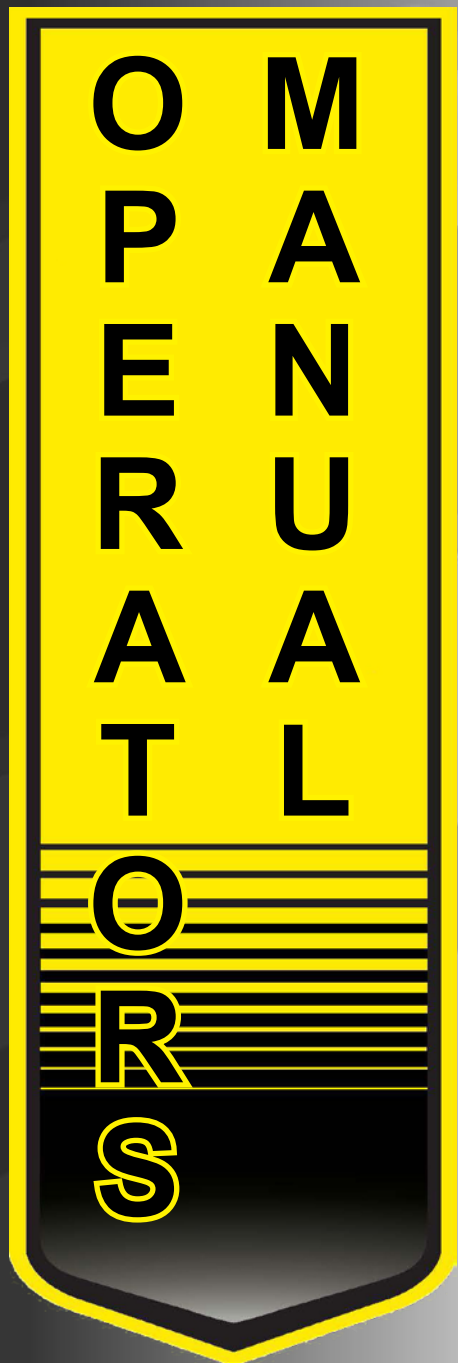

# 5114/5116 Hi-CAPACITY RAKE



## WARNING

READ AND UNDERSTAND THIS MANUAL BEFORE OPERATING THIS EQUIPMENT. UNSAFE OPERATION OR MAINTENANCE OF THIS EQUIPMENT CAN RESULT IN SERIOUS INJURY OR DEATH.

5114 Starting Ser. #911HCH4076

Part #72907

Rev. #01

HSMFG1118

**STRONG HERITAGE - STRONG PEOPLE - STRONGER FUTURE**

# CONTENTS

Warranty . . . . .	1
Manufacturer's Statement . . . . .	2
Warranty Registration Card . . . . .	3
Dealer Pre-Delivery Checklist . . . . .	5
Dealer Delivery Checklist . . . . .	7
Safety Information - Be Alert Symbol . . . . .	9
Explanation of Safety Signs . . . . .	10
Safety Decals . . . . .	11
Safety Information - Warning - Owner Must Read and Understand . . . . .	12
Cap Screw Torque Values . . . . .	13
Set-Up & Assembly . . . . .	14
Transporting . . . . .	15
Preparing for Operation . . . . .	16
Operation & Adjustments . . . . .	17-18
Optional Equipment . . . . .	19
Lubrication Guide . . . . .	20
Decal Location . . . . .	21-25
Troubleshooting . . . . .	26
Service Notes . . . . .	27-28
Specifications . . . . .	Inside Back Cover

# H&S WARRANTY

H&S Manufacturing Co., Inc. ("H&S") warrants this product to be free from defect in material and workmanship. Except as noted below, this warranty term is twelve (12) months on labor, and twenty-four (24) months on parts from the date of delivery of the product to the original purchaser by an authorized H&S dealer. Under this warranty, H&S will repair or replace, at its option, any covered part which is found to be defective in material or workmanship during the applicable warranty term. In no case will the covered repair cost of a part or parts exceed the replacement cost of that part. Warranty service must be performed by H&S or a dealer authorized by H&S to sell and/or service the product involved, which will use only new or remanufactured parts or components furnished by H&S. This warranty includes approved parts and labor to fix the product but does not include, and the purchaser is responsible for, any service call and/or transportation of the product to and from the dealer's place of business, for any premium charged for overtime labor requested by the purchaser, and for any service work not directly related to any defect covered under this warranty. This warranty includes only those components of the product manufactured by H&S. Warranty for any component not manufactured by H&S including, but not limited to, engines, batteries, tires, rims, hydraulic motors, pumps, etc. are covered by the warranty, if any, provided separately by their respective manufacturers.

This warranty in all its parts, is extended solely to the original purchaser of the product, is terminated upon any subsequent transfer or sale from or by the original purchaser and extends no third party benefits or rights whatsoever.

The warranty term for any product used in any commercial, custom, for hire or rental application, is limited to six (6) months from the date of delivery of the product to the original purchaser or the first day of service, whichever comes first, by an authorized H&S dealer.

For commercial, custom for hire, or rental application, warranty is limited to 6 months from the date of delivery to the original purchaser, or the first day in service, whichever is earlier.

This warranty does not include: (1) Any product that has been altered or modified in ways not approved by H&S; (2) Depreciation or damage caused by normal wear, use for which the product was not designed, misuse, improper or insufficient maintenance, improper operation, accident or failure to follow the product Operator's Manual recommendations and product decal recommendations; (3) Normal maintenance parts and service; (4) Repairs made with parts other than those available from H&S or performed by anyone other than H&S or a dealer authorized by H&S to sell and/or service the product involved.

To secure warranty service the purchaser must report the product defect to a dealer authorized by H&S to sell and/or service the product involved within the applicable warranty term together with evidence of the warranty start date and make the product available to that dealer within a reasonable period of time.

**THERE ARE NO WARRANTIES WHICH EXTEND BEYOND THE DESCRIPTION ON THE FACE OF THIS WARRANTY.** H&S and the companies affiliated with it makes no warranties, representations, or promises, express or implied, as to the performance or freedom from defect of its products other than those set forth above and **NO IMPLIED WARRANTY OF MERCHANTABILITY, FITNESS OR FITNESS FOR A PARTICULAR PURPOSE IS MADE. IN NO EVENT WILL THE DEALER, H&S OR ANY COMPANY AFFILIATED WITH H&S BE LIABLE FOR INCIDENTAL OR CONSEQUENTIAL DAMAGES.** The **ONLY REMEDY** the purchaser has in connection with the breach of performance of any warranty on H&S products are those set forth above.

The selling dealer has no authority to make any representation or promise on behalf of H&S, or to modify the terms or limitations of this warranty in any way.

11/14/18

## **MANUFACTURER'S STATEMENT**

Your New H&S Product has been manufactured of the finest quality materials and components. The performance you get from your machine is largely dependent upon how well you read and understand this manual and apply this knowledge. There is a right and a wrong way to do everything. Please do not assume that you know how to operate and maintain your Machine before reading this manual carefully. Keep this manual available for ready reference.

H&S reserves the right to make changes or add improvements to its products at any time without incurring any obligation to make such changes to products previously manufactured. Specifications, statements and descriptions of Products contained in this publication are subject to change without prior notification.

# WARRANTY REGISTRATION

- ❖ Date of Purchase: \_\_\_\_\_
  - ❖ Purchaser Name: \_\_\_\_\_
  - ❖ Street Address: \_\_\_\_\_
  - ❖ City: \_\_\_\_\_
  - ❖ State: \_\_\_\_\_ Zip: \_\_\_\_\_
  - ❖ Phone Number: \_\_\_\_\_
  - E-mail Address: \_\_\_\_\_
  - ❖ Product: \_\_\_\_\_
  - ❖ Model Number: \_\_\_\_\_
  - ❖ Serial Number: \_\_\_\_\_
  - ❖ You have received the Operators Manual for this product. Yes \_\_\_\_\_ No \_\_\_\_\_
- Interested in receiving the H&S Newsletter? Yes \_\_\_\_\_ No \_\_\_\_\_
- 
- ❖ Dealer Name: \_\_\_\_\_
  - ❖ Street Address: \_\_\_\_\_
  - ❖ City: \_\_\_\_\_
  - ❖ State: \_\_\_\_\_ Zip: \_\_\_\_\_
  - ❖ Signature: \_\_\_\_\_
- ❖ *All fields must be filled out to insure prompt notification of product and/or warranty updates.*

Please mail the completed WARRANTY REGISTRATION FORM to:  
H&S Manufacturing Co., Inc.  
2608 S. Hume Ave.  
Marshfield, WI 54449

(Remove Copy At Perforation)

**Intentionally Left Blank**

# DEALER PRE-DELIVERY CHECKLIST

## **AFTER COMPLETION, DEALER SHOULD REMOVE AND RETAIN FOR RECORDS**

After the rake has been completely set up, check to be certain it is in correct operating order before delivering to the customer. The following is a list of points to inspect. Check off each item as you have made the proper adjustments and found the item operating satisfactorily.

- Rake was not damaged in shipment. Check for dents and loose or missing parts. Report damage immediately to H&S Manufacturing Co., Inc.
- Rake has been correctly assembled according to instructions in this manual. Wheel nuts and all other fasteners are tightly secured.
- All bolts and fasteners are tight.
- All grease fittings have been lubricated. See Lubrication Chapter of this manual for details.
- Hoses and fittings are properly attached and there are no visible leaks.
- All mechanisms are operating trouble free.
- Rake wheels touch ground in unison when lowered into position (Rake setting level).
- Wheels are properly mounted.
- Tires are inflated to correct pressure.
- Decals are in place and legible.

Model Number \_\_\_\_\_

Serial Number \_\_\_\_\_

Dealer's Name \_\_\_\_\_

Inspection Date \_\_\_\_\_

Signature of Pre-Delivery Inspector \_\_\_\_\_

**Intentionally Left Blank**



# DEALER DELIVERY CHECKLIST

## **AFTER COMPLETION, DEALER SHOULD REMOVE AND RETAIN FOR RECORDS**

This check list that follows is an important reminder of valuable information that should be passed on to the customer at the time this Rake is delivered.

Check off each item as you explain it to the customer.

This delivery checklist, when properly filled out and signed, assures the customer that the pre-delivery service was satisfactorily performed.

- Explain to the customer that the pre-delivery inspection was made.
- Explain to the customer all the safety precautions they must exercise when operating this unit.
- Explain raking and windrow width adjustments.
- Explain to customer that regular lubrication is required for proper operation and long life of machine.
- Show customer the lubrication section of Owner's Manual.
- Give the customer Owner's Manual and make sure they read and understand all operating and service instructions.
- Have the customer sign a completed "Warranty Registration" and mail it.

Date Delivered \_\_\_\_\_

Dealer's Name \_\_\_\_\_

By \_\_\_\_\_

Signature of Original Buyer \_\_\_\_\_

Note: Warranty is not valid until warranty card is completed and returned to H&S Mfg. Co., Inc.

**Intentionally Left Blank**

## SAFETY INFORMATION



**BE  
ALERT!**

**YOUR SAFETY  
IS INVOLVED.**

**THIS SYMBOL IS USED THROUGHOUT THIS BOOK WHENEVER YOUR PERSONAL SAFETY IS INVOLVED. TAKE TIME TO BE CAREFUL. REMEMBER: THE CAREFUL OPERATOR IS THE BEST OPERATOR. MOST ACCIDENTS ARE CAUSED BY HUMAN ERROR. CERTAIN PRECAUTIONS MUST BE OBSERVED TO PREVENT THE POSSIBILITY OF INJURY OR DAMAGE.**

**H&S MANUFACTURING CO., INC.**

# SAFETY INFORMATION

## RECOGNIZE SAFETY INFORMATION

This is the safety alert symbol. When you see this symbol on your machine or in this manual, be alert to the potential for personal injury.

Follow recommended precautions and safe operating practices.



## UNDERSTAND SIGNAL WORDS

A signal word - DANGER, WARNING, or CAUTION - is used with the safety alert symbol. DANGER identifies the most serious hazards.

Safety signs with signal word DANGER or WARNING are typically near specific hazards.

General precautions are listed on CAUTION safety signs.



**WARNING**



**CAUTION**



## FOLLOW SAFETY INSTRUCTIONS

Carefully read all safety messages in this manual, and all safety signs on your machine. Follow all recommended precautions and safe operating procedures.

Keep signs in good condition. Immediately replace any missing or damaged signs.

## OBSERVE MAXIMUM TRANSPORT SPEED

**The maximum transport speed for this implement is 32 km/h (20 mph).**

Some tractors are capable of operating at speeds that exceed the maximum transport speed of this implement. Regardless of the maximum speed capability of the tractor being used to tow this implement, do not exceed the implement's maximum transport speed.

Exceeding the implement's maximum transport speed can result in:

- \* Loss of control of the tractor/implement combination
- \* Reduced or no ability to stop during braking
- \* Implement tire failure
- \* Damage to the implement structure or its components



Use additional caution and reduce speed when towing under adverse surface conditions, when turning, and when on inclines.



Do not attempt transport if the fully loaded implement weighs more than 1.5 times the weight of the tractor.

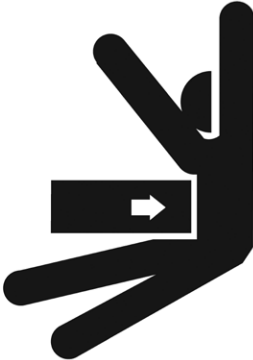

# SAFETY INFORMATION

	<b>WARNING</b>
<b>HELP AVOID INJURY</b>	
<ul style="list-style-type: none"><li>• READ &amp; UNDERSTAND THE OPERATORS MANUAL PROVIDED WITH THIS MACHINE. IF MISPLACED CALL H &amp; S MANUFACTURING AT 715-387-3414 WITH MODEL AND SERIAL NUMBER.</li><li>• UNDERSTAND ALL SAFETY WARNINGS AND FUNCTION OF CONTROLS.</li><li>• KEEP SAFETY DEVICES IN PLACE AND WORKING.</li><li>• KEEP YOURSELF AND OTHERS WELL CLEAR OF MOVING PARTS.</li><li>• DISCONNECT ALL POWER BEFORE SERVICING OR CLEANING THIS MACHINE.</li><li>• DO NOT EXCEED 20 MPH</li></ul>	
	72203A

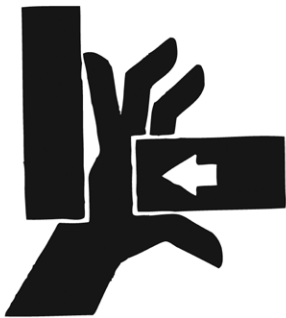
		<b>DANGER</b>
	<b>STAY CLEAR OF RAKE WHEN OPENING OR CLOSING.</b>	
	<b>FAILURE TO HEED THIS WARNING MAY RESULT IN PERSONAL INJURY OR DEATH</b>	
	<b>KEEP CLOTHING, YOURSELF AND OTHERS WELL CLEAR.</b>	
	11694A	

		<b>WARNING</b>
	<b>STAY CLEAR OF RAKE WHEN RAISING OR LOWERING RAKE WHEELS.</b>	
	<b>FAILURE TO HEED THIS WARNING MAY RESULT IN PERSONAL INJURY OR DEATH</b>	
	<b>KEEP CLOTHING, YOURSELF AND OTHERS WELL CLEAR</b>	
		2195

		<b>WARNING</b>
	<b>DO NOT GO NEAR LEAKS</b>	
	<ul style="list-style-type: none"><li>• High pressure oil easily punctures skin causing serious injury, gangrene or death.</li><li>• If injured, seek emergency medical help. Immediate surgery is required to remove oil.</li><li>• Do not use finger or skin to check for leaks.</li><li>• Lower load or relieve hydraulic pressure before loosening fittings.</li></ul>	
		11599

**TRACTOR:**

This operator's manual uses the term "Tractor" when identifying the power source.



# WARNING

**TO PREVENT SERIOUS INJURY OR DEATH**

BEFORE YOU ATTEMPT TO OPERATE THIS EQUIPMENT, READ AND STUDY THE FOLLOWING INFORMATION. IN ADDITION, MAKE SURE THAT EVERY INDIVIDUAL WHO OPERATES OR WORKS WITH THIS EQUIPMENT, WHETHER FAMILY MEMBER OR EMPLOYEE, IS FAMILIAR WITH THESE SAFETY PRECAUTIONS.

**DO NOT ALLOW PERSONNEL OTHER THAN THE QUALIFIED OPERATOR NEAR THE MACHINE.**

Stop the tractor engine, remove ignition key, and allow all mechanisms to stop before cleaning, working, or adjusting on machine.

**DO NOT** attempt to perform maintenance or repair with tractor running.

**DO NOT** step up on machine at any time.

**DO NOT** allow minors to operate or be near the machine.

Loose or floppy clothing should not be worn by the operator.

Stay clear of hydraulic lines, they may be under extreme pressure or heat.

Stay clear of rake when opening or closing main rake arm beams, or raising or lowering rake wheels.

For transport, always make sure that the hair pin at the rear of the lift pipes, and the transport lock bars with safety clip pins for main rake beam, are securely locked in place.

To reduce stress on rake arms, lift pipe, springs and spring brackets, reduce oil flow from tractor to lift cylinders whenever possible.

Be sure to raise rake wheels before opening or closing main rake beams.

H&S Manufacturing Co. always takes the operator and their safety into consideration and guards exposed moving parts for their protection. However, some areas cannot be guarded or shielded in order to assure proper operation. In addition, the operators manual and decals on the machine itself warn you of further danger and should be read and observed closely.

## Study The Above Safety Rules

**ATTENTION - BE ALERT - YOUR SAFETY IS INVOLVED**

# CAP SCREW TORQUE VALUES

The specifications below are the torque values for fasteners as it adheres to the SAE torque value standards. All fasteners should be torqued to the proper values found in the figures below unless otherwise specified by the engineering drawing.

Lubed torque would be any fastener that has grease, liquid Loctite, oil, etc. on the threads.

Dry torque would be any fastener which has threads that are clean and dry and do not have any liquid Loctite or grease on them.

## Hex Head Fasteners

The figure shown below shows how to determine what grade a fastener is.

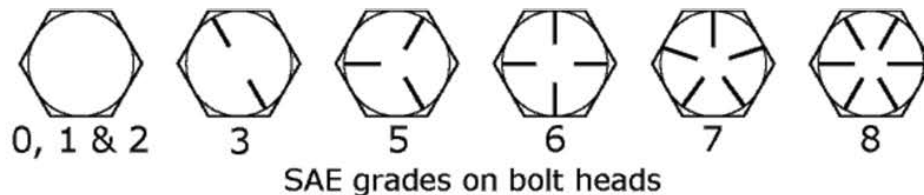

	SUGGESTED ASSEMBLY TORQUE VALUES						WORKING TORQUE			
	SAE GRADE 2 -6"		SAE GRADE 5		SAE GRADE 8		18-8 SS	316 SS	BRASS	SILICON BRONZE
Diam & Thrds Per Inch	Dry FT. LB.	LUB FT. LB.	Dry FT. LB.	LUB FT. LB.	Dry FT.LB.	LUB FT. LB.	IN LBS	IN LBS	IN LBS	IN LBS
1/4-20	5.5	4.2	8	6.3	12	9	75.2	78.8	61.5	68.6
1/4-28	6.3	4.7	10	7.2	14	10	94.0	99.0	77.0	87.0
5/16-18	11	8	17	13	24	18	132	138	107	123
5/16-24	12	9	19	14	27	20	142	147	116	131
3/8-16	20	15	30	23	45	35	236	247	192	219
3/8-24	23	17	35	25	50	35	259	271	212	240
7/16-14	32	24	50	35	70	50	376	393	317	349
7/16-20	36	27	55	40	80	60	400	418	327	371
1/2-13	50	35	75	55	110	80	517	542	422	480
1/2-20	55	40	85	65	120	90	541	565	443	502
9/16-12	70	55	110	80	150	110	682	713	558	632
9/16-18	80	60	120	90	170	130	752	787	615	697
5/8-11	100	75	150	110	210	160	1110	1160	907	1030
5/8-18	110	85	170	130	240	180	1244	1301	1016	1154
3/4-10	175	130	260	200	380	280	1530	1582	1249	1416
3/4-16	200	140	300	220	420	310	1490	1558	1220	1382
7/8-9	170	125	430	320	600	450	2328	2430	1905	2140
7/8-14	180	140	470	350	670	500	2318	2420	1895	2130
1-8	250	190	640	480	910	680	3440	3595	2815	3185
1-14	280	210	720	540	1020	760	3110	3250	2545	2885

## **SET-UP & ASSEMBLY**

**NOTE:** Determine right or left side of the wheel rake by viewing it from the rear. If instructions or parts lists call for hardened bolts, refer to Cap Screw Torque Values.

1. Assemble the rake or check the rake for proper assembly and adjustment. Make sure that all bolts are tightened.
2. Attach the wheels with tires, using the lug nuts furnished and torque the mounting hardware to 95 ft./lbs. of torque. Check wheel bolts periodically thereafter.
3. Check tires and inflate to the recommended pressure. (6.70 x 15 to 36 pounds.)
4. Lubricate the rake completely (See Lubrication Chapter in this manual).
5. Tooth bolts must be torqued to 40 ft./lbs. to help prevent excessive tooth breakage.  
**Re-torque rake tooth bolts after the first 100 acres. Check periodically thereafter.**



# TRANSPORTING

## TRANSPORT LOCKS

### Rake Beam Locks

Transport locks are mounted to the front of the pole. (A) Shows the rake locked into transport position. (B) Shows the transport locks in the convenient storage position, to be used when in the raking mode.

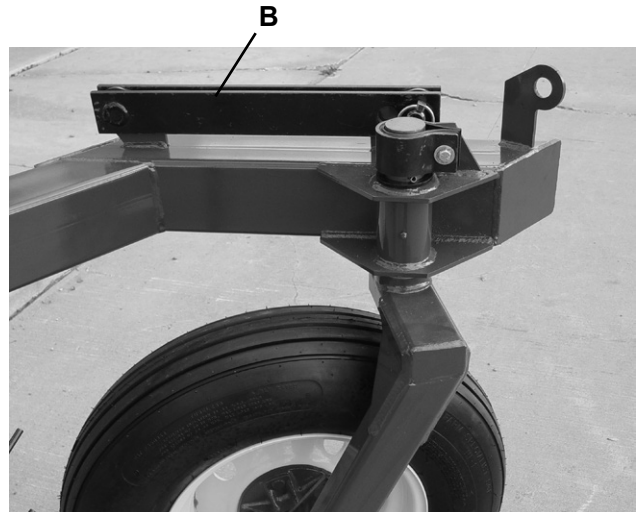
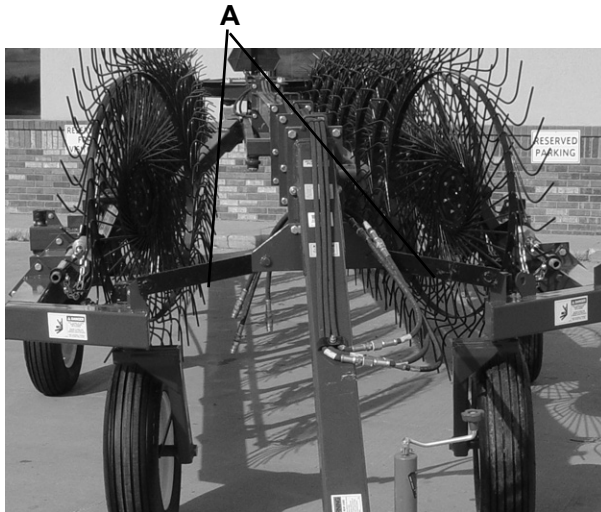

### Rake Wheel Locks

Located at the rear of the lift pipe is a hair pin, which is used to secure the rake wheels in the up position for transport (C). When in the down, or raking position, place the locking hair pin in the convenient storage position as shown (D).

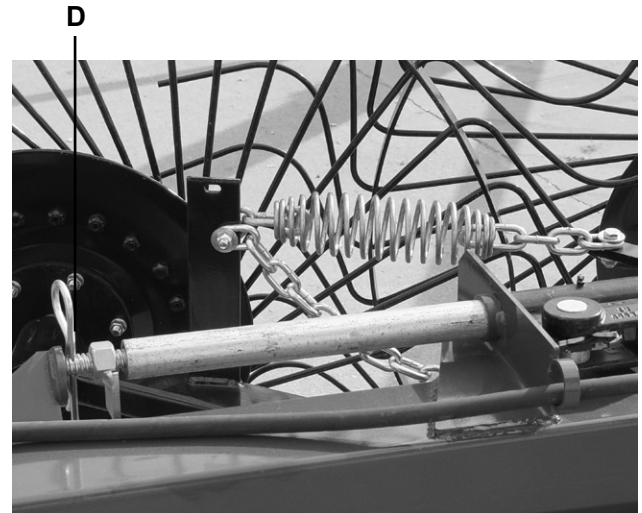

## TOWING ON HIGHWAY

Follow state and local regulations when towing farm equipment on public highways. Never tow the rake on a public highway at a speed greater than 20 mph (32 kph).

## REFLECTORS

Red and Amber reflective safety decals are on the rake for safety. Refer to the Decal Placement Chapter for location.

## PREPARING FOR OPERATION

1. Adjust the tractor hitch (13 to 17 inches above ground) and attach rake to tractor with a **hitch pin with a safety locking device**.



2. There are ten different positions to adjust the hitch on your new **HI-CAPACITY** Rake. Hitch should be adjusted so main frame of the rake is level or parallel to the ground.

3. Remove weight from lift jack. Remove jack from pipe and place on convenient storage mount located on the front top of pole.



4. Connect hydraulic hose for raising and lowering rake wheels from rake to a double-acting valve on the tractor.

5. Connect hydraulic hoses for opening and closing the rake to a double acting valve on the tractor.

6. Connect 7-pin electrical connector to tractor (if equipped with optional lighting).

# OPERATION & ADJUSTMENTS

## EMERGENCY SHUTDOWN

Stop the tractor engine, remove ignition key, and allow all mechanisms to stop before cleaning or working on the machine.

## RAKING WIDTH

Raking width is determined by setting the spring loaded stop, located above the rear pole section as shown.

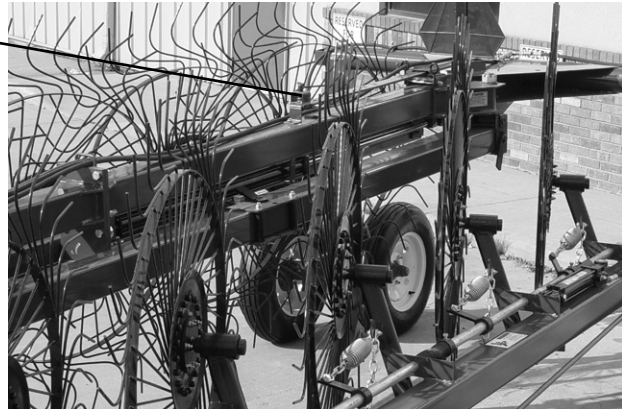
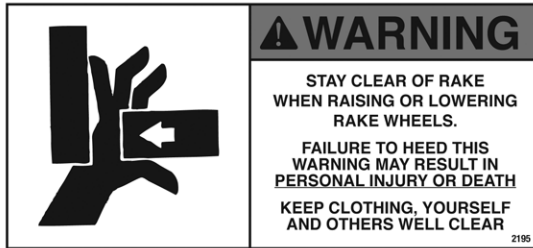

## GROUND PRESSURE

Rake wheel to ground pressure is adjusted by turning the threaded rod while the rake wheels are in the raised position. This allows the tab nut to stay stationary while the threaded rod rotates, thus decreasing pressure, or increasing pressure. The further forward that the nut is on the threaded rod, the lesser the amount of rake wheel ground pressure. The further back that the nut is on the threaded rod, the greater the amount of rake wheel ground pressure.

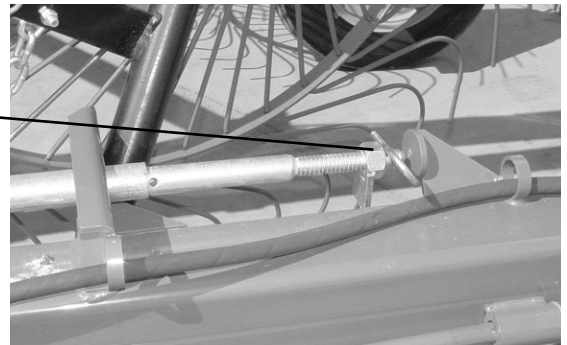

## WINDROW WIDTH

Windrow width is adjustable from 38" to 58". Adjustment is made by turning the crank, located on the left of the rear of the rake as shown.



# OPERATION & ADJUSTMENTS

## GAUGE WHEELS

Outboard gauge wheels are located on the forward section of each rake beam. These gauge wheels support the rake beams to allow the rake wheels to better follow the contour of the ground. Located on the gauge wheel pivot spindle is an adjustable brake assembly. Adjust brake by tightening bolt. The brake should have enough tension to prevent zig-zag motion, but still allow the wheel to pivot when making corners.



Adjustable  
Brake  
Assembly

# OPTIONAL EQUIPMENT

## OPTIONAL CENTER KICKER WHEEL

There are two optional center kicker wheel assemblies available for the 5114/5116 **HI-CAPACITY** Rakes. If the hay is laying out flat, these extra wheels allow you to raise the hay laying in the center of the rake out of the stubble for faster drying, and easier pick-up. A separate cylinder controls the kicker wheel assembly. It raises and lowers with the rake wheels.

### 2-Wheel Center Kicker Wheel

To engage center kicker wheels, hydraulically open rake to desired raking width. Remove Locking Pin (C), swivel kicker wheel assembly to the desired raking angle. Reinsert the locking pin. Next, remove Locking Pin (A) from transport lock position, and insert into convenient Storage Position (B). Lower rake wheels to begin raking.

To return to transport position, PRIOR TO CLOSING RAKE, raise rake wheels. (This will also raise the center kicker wheel assembly). Remove Locking Pin (C), Swivel kicker wheel assembly so that it is in line with the hitch pole. Re-insert Pin (C). Remove locking pin from Storage Position (B), and insert to lock the unit into the up, or Transport Position (A). Rake beams may now be closed for transport.

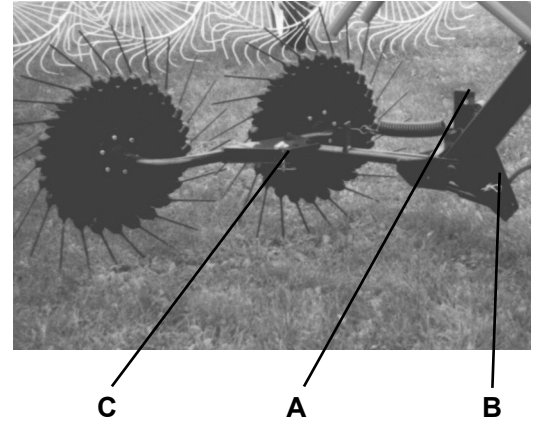

### 3-Wheel Center Kicker Wheel

To engage center kicker wheels, hydraulically open rake to desired raking width. Remove Locking Pin (A), swivel kicker wheel assembly to the desired raking angle. Reinsert the Locking Pin. Next, remove Locking Pin (B) from the oscillation lock position, and insert into the convenient storage position (C). Next remove the transport lock pin (D) and insert into the convenient storage position (E). Lower rake wheels to begin raking.

To return to transport position, PRIOR TO CLOSING RAKE, raise rake wheels. (This will also raise the center kicker wheel assembly). Remove Locking Pin (A), Swivel kicker wheel assembly so that it is in line with the hitch pole. Re-insert Pin (A). Remove locking pin from Storage Position (C), and re-insert pin (B) into the oscillation lock position. Next remove lock pin (D) from storage position (E) and insert to lock the unit into the up, or Transport Position. Rake beams may now be closed for transport.

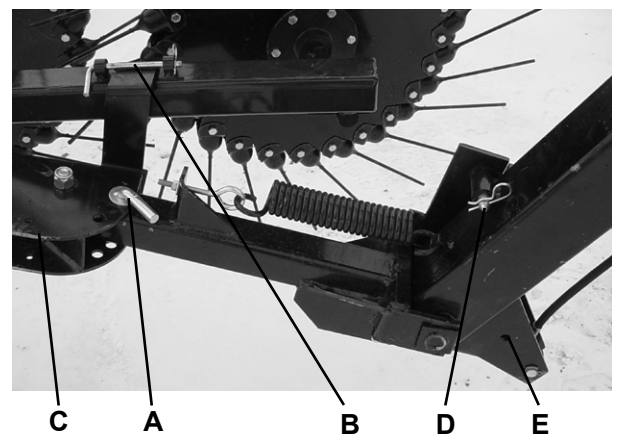

# LUBRICATION GUIDE

## GREASE FITTINGS

There are numerous grease fittings on the 5114 and 5116 **HI-CAPACITY** Rakes. If equipped with a center kicker wheel, there will be one more on the pivot point. Lubricating properly and often enough will prolong the life of your **HI-CAPACITY** Rake. Grease daily during normal use and **before and after storage and after power washing**. Use a good grade of high quality grease. Make sure that grease comes out around the shaft on sleeve type bearings. Wipe off excessive grease to prevent accumulation of chaff or grit around the bearing.

## LOCATION

Listed and shown are the description of location and number of grease fittings.

- A. (2) Top Opening Arm Front Pivot
- B. (4) One on Each Gauge Wheel
- C. (2) One on Each Lift Cylinder Mounting Bracket
- D. (2) One on Each Rake Beam Pivot
- E. (6) Top Rear Windrow Width Adjustment
- F. (5) Top Opening Arm Rear Pivot
- G. (1) Center Kicker Wheel Pivots (If Equipped)
- (8) One on Each Transport Wheel Hub

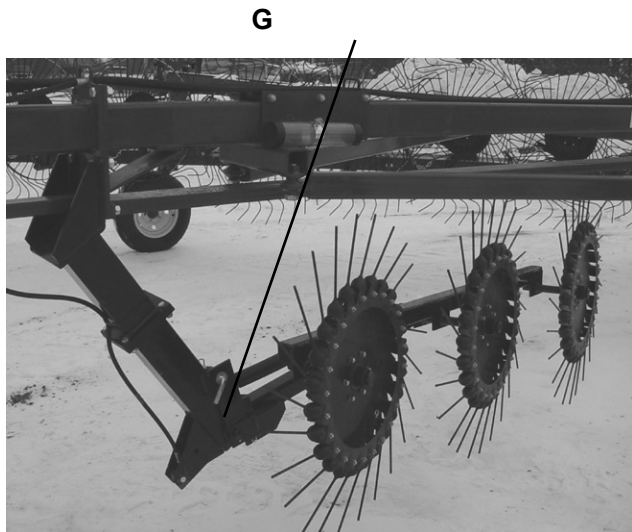
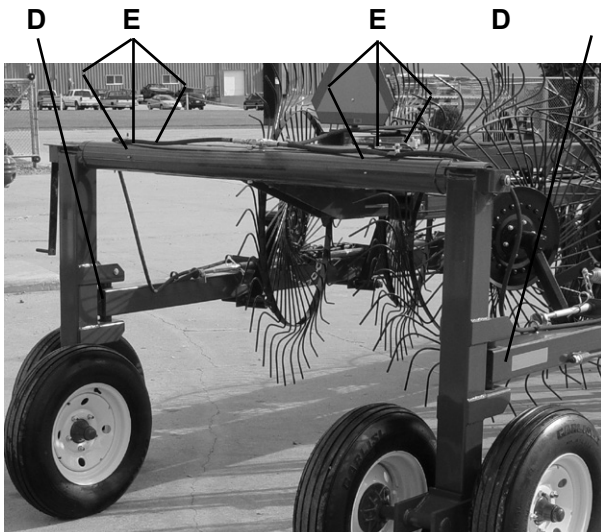
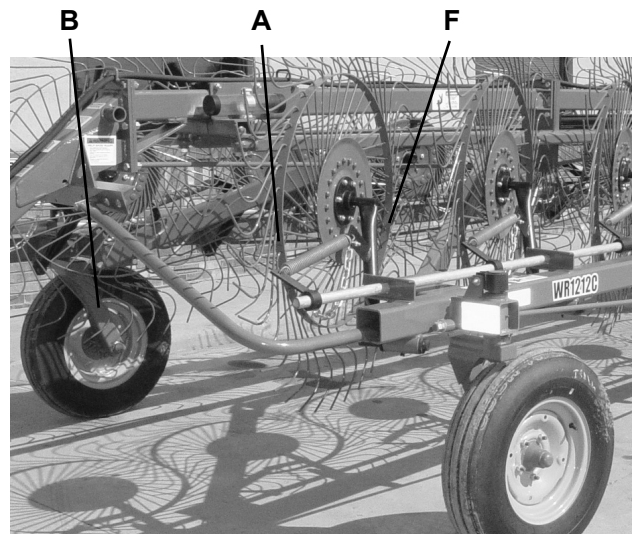
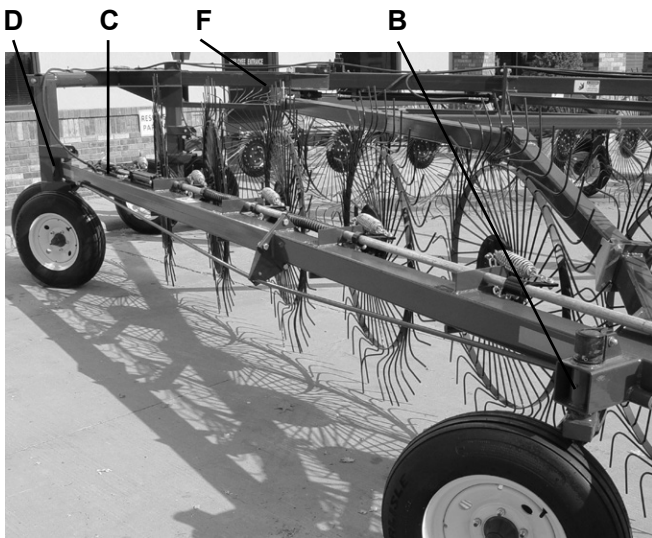

## DECAL LOCATION

Your rake was manufactured with operator safety in mind. Located on the **Hi-CAPACITY** Rake are various decals to aid in operation and warn of danger or caution areas. Pay close attention to all the decals.



**DO NOT REMOVE ANY OF THESE DECALS. IF DECALS ARE LOST, DAMAGED, OR IF THE *Hi-CAPACITY* RAKE IS REPAINTED, REPLACE DECALS. REMEMBER: DECALS ARE FOR YOUR PROTECTION AND INFORMATION.**

Listed below are the decals on your H&S **Hi-CAPACITY** Rake. These decals may be ordered individually by part number or by ordering complete set.

<u>PART</u>	<u>QUANTITY</u>	<u>DESCRIPTION</u>
311	1	Patent Numbers
2195	4	WARNING - Stay Clear of Rake
71273	2	Model Decal 5114
71275	2	H&S <b>Hi-CAPACITY</b> Rake Decal Left & Rear 5114
71277	1	H&S <b>Hi-CAPACITY</b> Rake Decal Right 5114
093020	19	Grease Zerk
11501B	2	ATTENTION: Remove Both Pins
11599	3	WARNING - Do Not Go Near Leaks
11694A	8	DANGER - Stay Clear of Rake
12197A	1	Attention: Raise Rake Wheels
54033	1	Made in the USA
71188B	1	Jack Storage Position
72203A	1	WARNING - Help Avoid Injury
BFR723	1	SMV Sign Kit
DCAMB	4	Amber Reflector - 2" x 9" (2 On Each Main Rake Beam)
DCAMB1	1	Amber Reflector - 3-1/4" x 5-5/8"
DCRED	2	Red Reflectors



# DECAL LOCATION

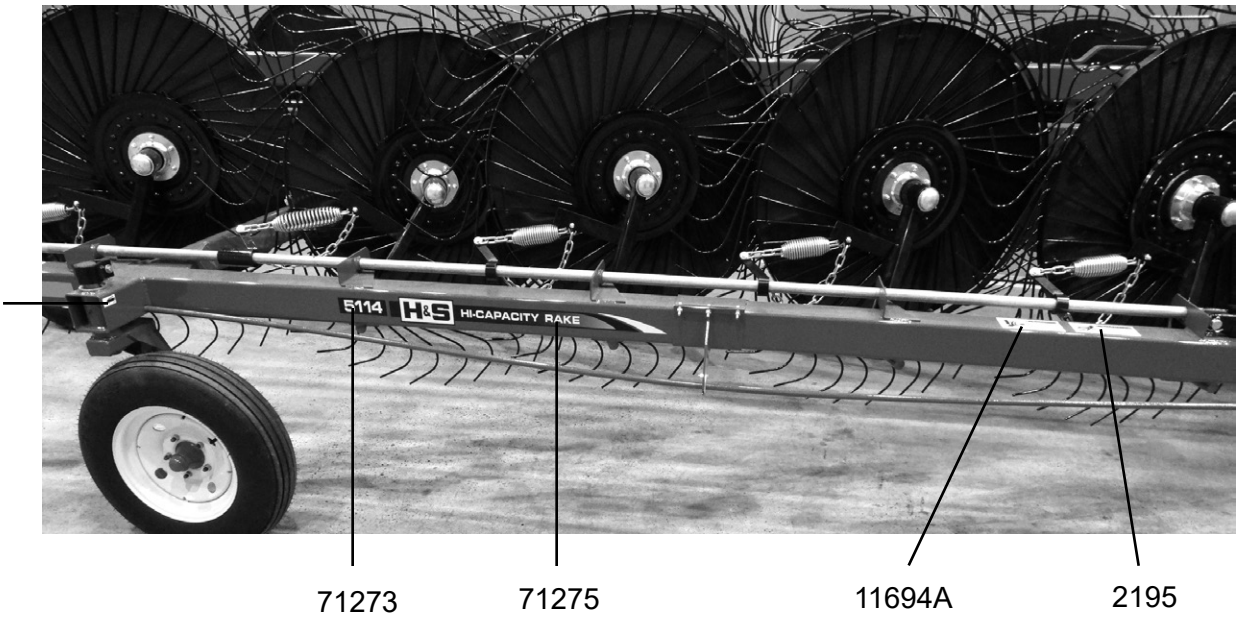
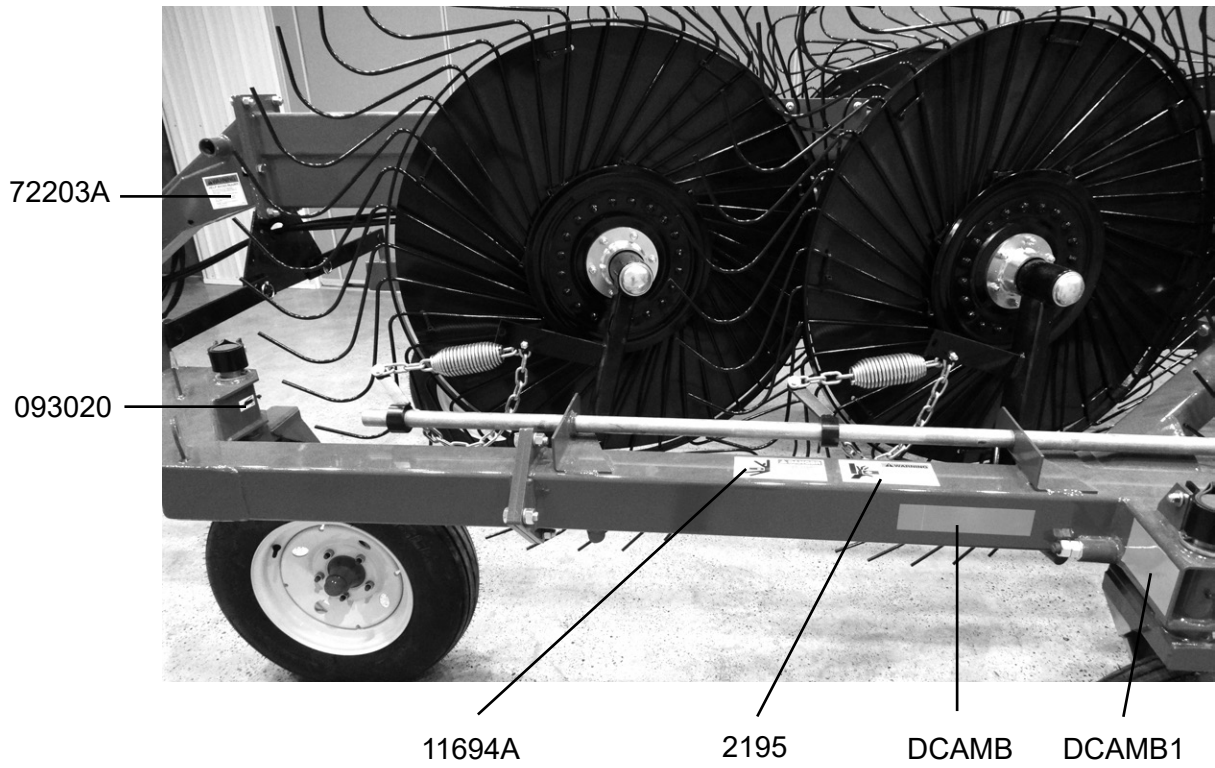





# DECAL LOCATION

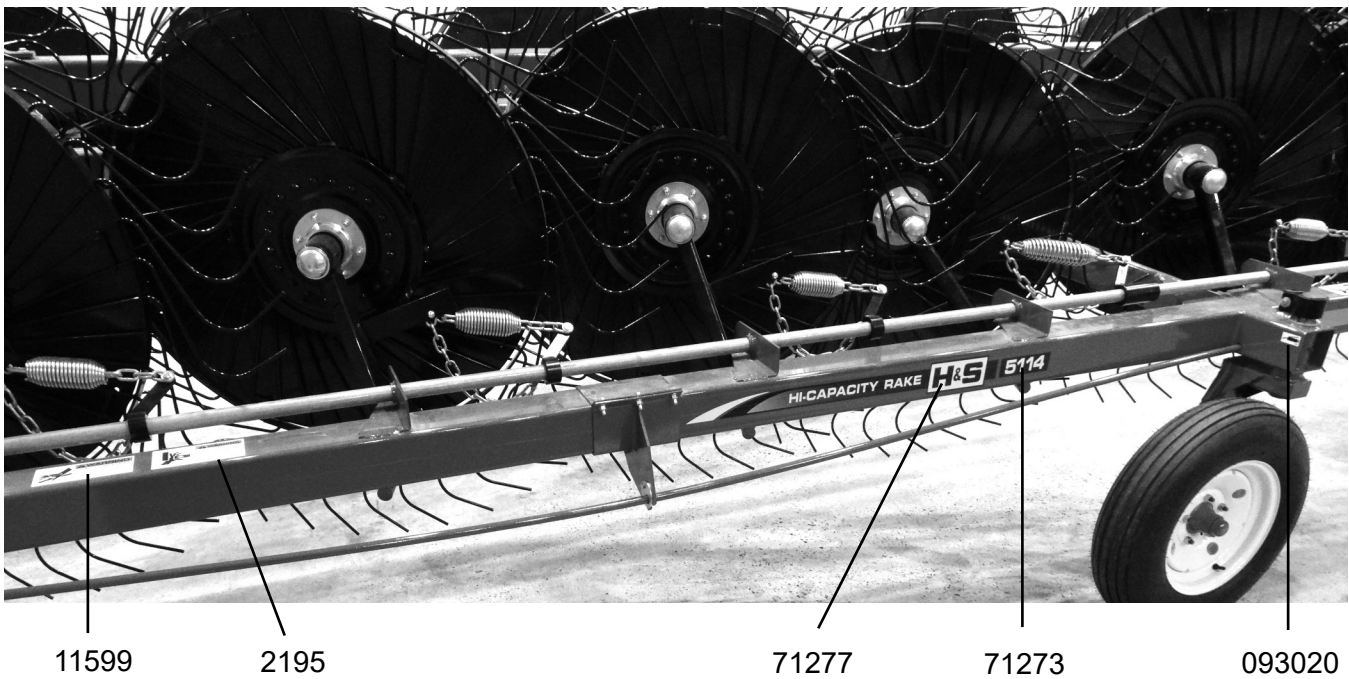
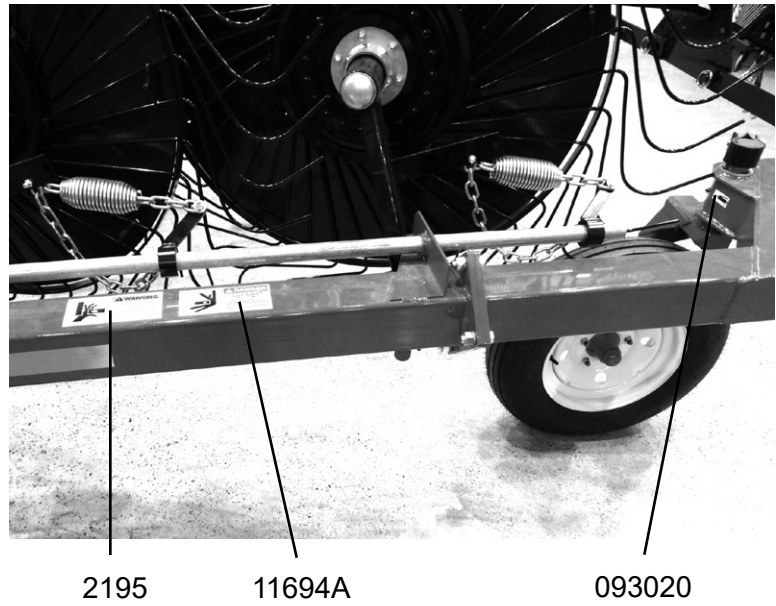

# DECAL LOCATION

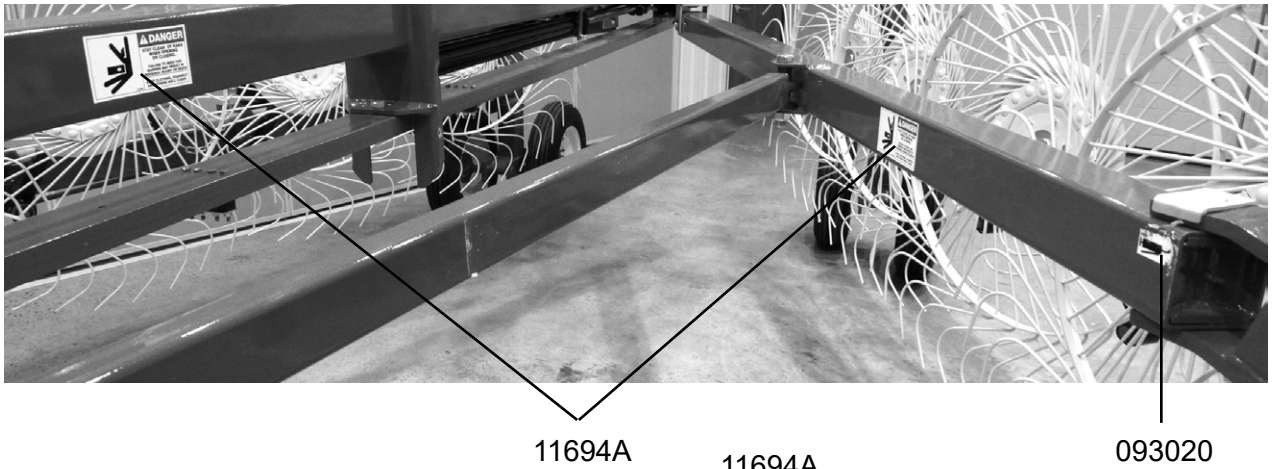
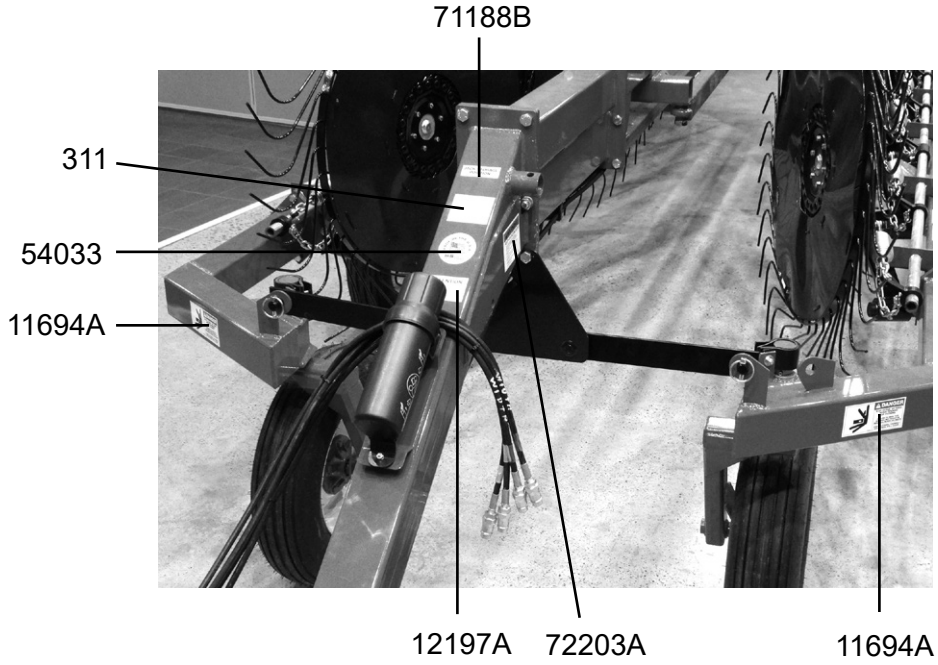

# TROUBLESHOOTING



**WARNING:**

**MAKE SURE THAT THE TRACTOR IS SHUT OFF AND THE RAKE CANNOT MOVE BEFORE SERVICING THE 1460-1660 *Hi-CAPACITY* RAKE. MAINTENANCE AND REPAIR SERVICE WORK TO BE PERFORMED BY A QUALIFIED SERVICE PERSON ONLY.**

<u>TROUBLE</u>	<u>POSSIBLE CAUSE</u>	<u>POSSIBLE REMEDY</u>
Rake Will Not Open	Rake Locked In Transport  Hydraulic Couplers Not Coupled To Tractor Properly  Hydraulic Hoses Mixed Up With Rake Wheel Lift Hose  Tractor Hydraulics Do Not Have Sufficient Pressure	Remove Transport Locks And Return To Storage Position  Couple Hydraulic Hoses To Tractor  Sort Hoses Correctly And Re-couple To Tractor  Tractor Should Have At Least 1500 PSI To Operate Rake NOTE: Always Drive Forward Slowly And Open Rake At The Same Time
Rake Will Not Close	Tractor Hydraulics Do Not Have Sufficient Pressure	Tractor Should Have At Least 1500 PSI To Operate Rake NOTE: Always Drive Forward Slowly And Open Rake At The Same Time
Rake Wheels Will Not Lower	Rake Wheels Locked In Transport  Lift Pipe Binding  Tractor Hydraulics Not Able To Operate Single Acting Cylinder	Remove Hair Pin From Adjuster, Place In Storage Position  Check Lift Pipe Make Sure It Is Free Moving  Consult Your Tractor Dealer on How This Can Be Accomplished





## SPECIFICATIONS

Number of Wheels.....	14.....	16
Wheel Diameter.....	60".....	60"
Teeth per Wheel.....	40.....	40
Tooth Diameter.....	7mm.....	7mm
Transport Width.....	8'8".....	8'8"
Transport Length.....	27'3".....	30'3"
Maximum Raking Width.....	28'.....	32'
Windrow Width Adjustment.....	38"-58".....	38"-58"
Weight.....	4200 lbs.....	4600 lbs.
Rake Wheel Hubs.....	Ball Bearings.....	
Hitch Jack.....	Standard.....	
Tail Lights.....	Optional.....	
Center Kicker Wheel.....	Optional.....	
Tires.....	8 - 6.70 x 15.....	

# **H&S MFG. CO.**

products approved

for the

## **FEMA**

# **SEAL OF QUALITY**



Manufactured by:

**H&S MANUFACTURING CO., INC.**

2608 S. HUME AVE. MARSHFIELD, WI 54449

(715) 387-3414 | [hsmfco.com](http://hsmfco.com)

