

H&S

4242 & 4255 HYDRA-PUSH MANURE SPREADER



WARNING

READ AND UNDERSTAND THIS MANUAL BEFORE OPERATING THIS EQUIPMENT. UNSAFE OPERATION OR MAINTENANCE OF THIS EQUIPMENT CAN RESULT IN SERIOUS INJURY OR DEATH.

HPV4242 Starting Ser. #322VP42025
HPH4242 Starting Ser. #322HP42006
HPV4255 Starting Ser. #322VP55020
HPH4255 Starting Ser. #322HP55002

Part #89980

Rev. #01

HSMFG0223

O P E R A T O R S
M A N U A L

STRONG HERITAGE - STRONG PEOPLE - STRONGER FUTURE

CONTENTS

Warranty	1
Manufacturer's Statement	2
Warranty Registration Form	3
Dealer Pre-Delivery Checklist	5
Dealer Delivery Checklist	7
Safety Information - Be Alert Symbol	9
Explanation of Safety Signs	10
Safety Decals	11-13
Safety Information - Warning - Owner Must Read and Understand	14
Cap Screw Torque Values	15
Hydraulic Torque Specs.	16-17
Set-Up & Assembly	18
Transporting	19
Preparing for Operation	20-21
Operation	22
Service & Adjustments	23
Adjustments	24
Vertical Beaters	25
Optional Equipment	26
Lubrication Guide	27-28
Decal Location	29-36
Troubleshooting	37
Service Notes	38

H&S WARRANTY

H&S Manufacturing Co., Inc. ("H&S") warrants this product to be free from defect in material and workmanship. Except as noted below, this warranty term is twelve (12) months on parts and labor, and twenty-four (24) months on parts only from the date of delivery of the product to the original purchaser by an authorized H&S dealer. Under this warranty, H&S will repair or replace, at its option, any covered part which is found to be defective in material or workmanship during the applicable warranty term. In no case will the covered repair cost of a part or parts exceed the replacement cost of that part. In no case, unless pre-authorized by H&S, will a component be replaced versus repaired unless the cost of labor and parts exceeds 75% of the cost of a new component. Warranty repairs must be performed by H&S or a dealer authorized by H&S to sell and/or service the product involved, and will use only new or remanufactured parts or components furnished by H&S. Any warranty repairs needing to be performed by a third party must be pre-authorized by H&S. Standard freight costs will be covered by H&S for any part used to make a warrantable repair, any form of express freight will not be covered unless pre-authorized by H&S. This warranty includes approved parts and labor to repair the product but does not include, and the purchaser is responsible for, any service call and/or transportation of the product to and from the dealer's place of business, for any costs related to travel, for any premium charged for overtime labor requested by the purchaser, and for any service work not directly related to any defect covered under this warranty.

This warranty includes only those components of the product manufactured by H&S. Warranty for any component not manufactured by H&S including, but not limited to, engines, batteries, tires, rims, hydraulic motors, pumps, etc. are covered by the warranty, if any, provided separately by their respective manufacturers. H&S reserves the right to request the return of any failed component.

This warranty in all its parts is extended solely to the original purchaser of the product, is terminated upon any subsequent transfer or sale from or by the original purchaser, and extends no third party benefits or rights whatsoever.

The warranty term for any product used in any for hire, rental fleet or rental application, is limited to six (6) months from the date of delivery of the product to the original purchaser by an authorized H&S dealer.

This warranty does not include: (1) Any product that has been altered or modified in ways not approved by H&S; (2) Depreciation or damage caused by normal wear, use for which the product was not designed, misuse, improper or insufficient maintenance, improper operation, accident or failure to follow the product Operator's Manual recommendations and product decal recommendations; (3) Normal maintenance parts and service; (4) Repairs made with parts other than those available from H&S or performed by anyone other than H&S or a dealer authorized by H&S to sell and/or service the product involved.

To secure warranty service the purchaser must report the product defect to a dealer authorized by H&S to sell and/or service the product involved within the applicable warranty term together with evidence of the warranty start date and make the product available to that dealer within a reasonable period of time.

For these warranty terms to be in effect the selling authorized H&S dealer and/or the customer must submit the warranty registration to H&S.

THERE ARE NO WARRANTIES WHICH EXTEND BEYOND THE DESCRIPTION ON THE FACE OF THIS WARRANTY. H&S and the companies affiliated with it make no warranties, representations, or promises, express or implied, as to the performance or freedom from defect of its products other than those set forth above and NO IMPLIED WARRANTY OF MERCHANTABILITY, FITNESS OR FITNESS FOR A PARTICULAR PURPOSE IS MADE. IN NO EVENT WILL THE DEALER, H&S OR ANY COMPANY AFFILIATED WITH H&S BE LIABLE FOR INCIDENTAL OR CONSEQUENTIAL DAMAGES. The ONLY REMEDY the purchaser has in connection with the breach of performance of any warranty on H&S products are those set forth above.

The selling dealer has no authority to make any representation or promise on behalf of H&S, or to modify the terms or limitations of this warranty in any way.

12/20/22

MANUFACTURER'S STATEMENT

Congratulations on your selection of an H&S product. Your new H&S product has been manufactured of the finest quality materials and components. The performance you receive from your machine is largely dependent upon how well you read, understand this manual, and apply this knowledge. There is a right and a wrong way to do everything. Please do not assume that you know how to operate and maintain your machine before reading this manual carefully. Keep this manual available for ready reference. We are very appreciative of your patronage.

H&S reserves the right to make changes or add improvements to its products at any time without incurring any obligation to make such changes to products previously manufactured. Specifications, statements and descriptions of products contained in this publication are subject to change without prior notification.

WARRANTY REGISTRATION

- Date of Purchase: _____
- Purchaser Name: _____
- Street Address: _____
- City: _____
- State: _____ Zip: _____
- Phone Number: _____
- E-mail Address: _____
- Product: _____
- Model Number: _____
- Serial Number: _____
- You have received the Operator's Manual for this product. Yes _____ No _____
- Interested in receiving the H&S E-mail Newsletter? Yes _____ No _____

-
- Dealer Name: _____
 - Street Address: _____
 - City: _____
 - State: _____ Zip: _____
 - Signature: _____

- All fields must be filled out to ensure prompt notification of product and/or warranty updates.

**Please mail the completed WARRANTY REGISTRATION FORM to:
H&S Manufacturing Co., Inc.
2608 S. Hume Ave.
Marshfield, WI 54449**

Intentionally Left Blank

H&S DEALER PRE-DELIVERY CHECKLIST

AFTER COMPLETION, DEALER SHOULD REMOVE AND RETAIN FOR RECORDS

After the Manure Spreader has been completely set up, check to be certain it is in correct operating order before delivering to the customer. The following is a list of points to inspect. Check off each item as you have made the proper adjustments and found the item operating satisfactorily.

- Manure spreader was not damaged in shipment. Check for dents and loose or missing parts. Report damage immediately to H&S Manufacturing Co., Inc.
- All bolts and fasteners are tight.
- Manure spreader has been correctly assembled according to instructions in this manual.
- All grease fittings have been lubricated. Gearbox is filled to proper level.
- Hoses and fittings are properly attached and there are no visible leaks.
- Guards and shields are secure.
- Wheels are properly mounted to torque specifications.
- Tires are inflated to correct pressure.
- Drive chain tension and alignment is correct.
- Decals are in place and legible.

Connect the manure spreader onto a proper horsepower tractor and attach the PTO and connect the lights. Connect the hydraulic hoses to the tractor remote outlets. Run the manure spreader and make sure all components operate properly.

- PTO guard turns freely.
- Hydraulic end gate operates smoothly.
- Hydraulic pusher operates smoothly.
- Hydraulic system does not leak under pressure.
- Lights and wiring functioning properly.
- Implement and all components are functioning properly.

Model Number _____ Serial # _____

Dealer's Name _____

Inspection Date _____

Signature of Pre-Delivery Inspector _____

(Remove Dealer File Copy At Perforation)

Intentionally Left Blank

DEALER DELIVERY CHECKLIST

AFTER COMPLETION, DEALER SHOULD REMOVE AND RETAIN FOR RECORDS

This checklist that follows is an important reminder of valuable information that should be passed on to the customer at the time this Manure Spreader is delivered.

Check off each item as you explain it to the customer.

This delivery checklist, when properly filled out and signed, assures the customer that the pre-delivery service was satisfactorily performed.

- Explain to the customer that the pre-delivery inspection was made.
- Explain to the customer all the safety precautions they must exercise when operating this unit.
- Explain recommended loads for different types of materials.
- Explain to customer that regular lubrication is required for proper operation and long life of machine.
- Show customer the lubrication section of Owner's Manual.
- Give the customer Owner's Manual and make sure they read and understand all operating and service instructions.
- Have the customer sign a completed "Warranty Registration" and mail it.

Date Delivered _____

Dealer's Name _____

By _____

Signature of Original Buyer _____

Note: Warranty is not valid until warranty card is completed and returned to H&S Mfg. Co., Inc.

Intentionally Left Blank

SAFETY INFORMATION



**BE
ALERT!**

**YOUR SAFETY
IS INVOLVED.**

THIS SYMBOL IS USED THROUGHOUT THIS BOOK WHENEVER YOUR PERSONAL SAFETY IS INVOLVED. TAKE TIME TO BE CAREFUL. REMEMBER: THE CAREFUL OPERATOR IS THE BEST OPERATOR. MOST ACCIDENTS ARE CAUSED BY HUMAN ERROR. CERTAIN PRECAUTIONS MUST BE OBSERVED TO PREVENT THE POSSIBILITY OF INJURY OR DAMAGE.

H&S MANUFACTURING CO., INC.

SAFETY INFORMATION

RECOGNIZE SAFETY INFORMATION

This is the safety alert symbol. When you see this symbol on your machine or in this manual, be alert to the potential for personal injury.

Follow recommended precautions and safe operating practices.



UNDERSTAND SIGNAL WORDS

A signal word - DANGER, WARNING, or CAUTION - is used with the safety alert symbol. DANGER identifies the most serious hazards.



Safety signs with signal word DANGER or WARNING are typically near specific hazards.



WARNING

General precautions are listed on CAUTION safety signs.



CAUTION



FOLLOW SAFETY INSTRUCTIONS

Carefully read all safety messages in this manual, and all safety signs on your machine. Follow all recommended precautions and safe operating procedures.

Keep signs in good condition. Immediately replace any missing or damaged signs.

OBSERVE MAXIMUM TRANSPORT SPEED

The maximum transport speed for this implement is 32 km/h (20 mph).

Some tractors are capable of operating at speeds that exceed the maximum transport speed of this implement. Regardless of the maximum speed capability of the tractor being used to tow this implement, do not exceed the implement's maximum transport speed.

Exceeding the implement's maximum transport speed can result in:

- * Loss of control of the tractor/implement combination
- * Reduced or no ability to stop during braking
- * Implement tire failure
- * Damage to the implement structure or its components

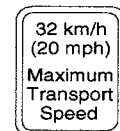

Use additional caution and reduce speed when towing under adverse surface conditions, when turning, and when on inclines.

Do not attempt transport if the fully loaded implement weighs more than 1.5 times the weight of the tractor.

SAFETY DECALS

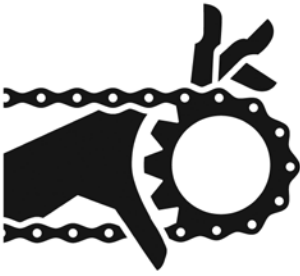
	<p style="text-align: center;">⚠ WARNING</p> <p style="text-align: center;">DO NOT OPERATE THIS EQUIPMENT IF THIS DECAL IS EXPOSED. REPLACE SAFETY SHIELDS.</p> <p style="text-align: right; font-size: small;">1494A</p>
---	---

	<p style="text-align: center;">⚠ WARNING</p> <p style="text-align: center;">DO NOT GO NEAR LEAKS</p> <ul style="list-style-type: none"> • High pressure oil easily punctures skin causing serious injury, gangrene or death. • If injured, seek emergency medical help. Immediate surgery is required to remove oil. • Do not use finger or skin to check for leaks. • Lower load or relieve hydraulic pressure before loosening fittings. <p style="text-align: right; font-size: small;">11599</p>
---	--

	<p style="text-align: center;">⚠ WARNING</p> <p style="text-align: center;">DO NOT REMOVE SHIELDS ROTATING PARTS INSIDE</p> <p style="text-align: right; font-size: small;">12794</p>
---	---

	<p style="text-align: center;">⚠ DANGER</p> <p style="text-align: center;">STAY CLEAR WHEN MANURE SPREADER IS OPERATING</p> <hr style="width: 50%; margin: auto;"/> <p style="text-align: center; font-size: small;">FAILURE TO HEED THIS WARNING MAY RESULT IN PERSONAL INJURY OR DEATH</p> <p style="text-align: center;">KEEP CLOTHING, YOURSELF AND OTHERS WELL CLEAR.</p> <p style="text-align: right; font-size: small;">1906D</p>
---	---

<p style="margin: 0;">⚠ DANGER</p>

<p style="text-align: center;">ROTATING DRIVELINE CONTACT CAN CAUSE DEATH KEEP AWAY!</p> <p style="text-align: center;">DO NOT OPERATE WITHOUT-</p> <ul style="list-style-type: none"> • ALL DRIVELINE, TRACTOR AND EQUIPMENT SHIELDS IN PLACE. • DRIVELINES SECURELY ATTACHED AT BOTH ENDS. • DRIVELINE SHIELDS THAT TURN FREELY ON DRIVELINE. <p style="text-align: right; font-size: small;">1494L</p>

<p style="margin: 0;">⚠ WARNING</p>
<p style="text-align: center;">DO NOT OPERATE THIS EQUIPMENT IF THIS DECAL IS EXPOSED. REPLACE SAFETY SHEILDS.</p> <p style="text-align: right; font-size: small;">32597A</p>

<p style="margin: 0;">⚠ WARNING</p>
<p style="text-align: center;">HELP AVOID INJURY</p> <ul style="list-style-type: none"> • READ & UNDERSTAND THE OPERATORS MANUAL PROVIDED WITH THIS MACHINE. IF MISPLACED CALL H & S MANUFACTURING AT 715-387-3414 WITH MODEL AND SERIAL NUMBER. • UNDERSTAND ALL SAFETY WARNINGS AND FUNCTION OF CONTROLS. • KEEP SAFETY DEVICES IN PLACE AND WORKING. • KEEP YOURSELF AND OTHERS WELL CLEAR OF MOVING PARTS. • DISCONNECT ALL POWER BEFORE SERVICING OR CLEANING THIS MACHINE. • DO NOT EXCEED 20 MPH <p style="text-align: right; font-size: small;">72203A</p>

SAFETY DECALS

⚠ DANGER



**NEVER
ALLOW
RIDERS
ON THIS
MACHINE**

9194B

⚠ DANGER



**STAY CLEAR OF
BEATER IF TRACTOR
OR PTO IS RUNNING.**

MANURE AND FOREIGN
OBJECTS CAN BE THROWN
CONSIDERABLE DISTANCES.

FAILURE TO HEED THIS
WARNING MAY RESULT IN
PERSONAL INJURY OR DEATH.

KEEP CLOTHING, YOURSELF,
AND OTHERS WELL CLEAR.

58703

⚠ WARNING



**DO NOT CLEAN
OR WORK ON THIS
MACHINE WITHOUT
FIRST DISENGAGING
POWER AND
SHUTTING OFF
TRACTOR ENGINE.**

1494J

⚠ WARNING



**DO NOT
REMOVE
SHIELDS
MOVING
PARTS
INSIDE**

1494K

⚠ DANGER



**STAY CLEAR OF
BEATER IF
TRACTOR OR
PTO IS RUNNING.**

MANURE AND
FOREIGN OBJECTS
CAN BE THROWN
CONSIDERABLE
DISTANCES.

FAILURE TO HEED THIS
WARNING MAY
RESULT IN
PERSONAL INJURY
OR DEATH.

KEEP CLOTHING,
YOURSELF, AND
OTHERS WELL
CLEAR.

86060



111593A

⚠ DANGER

**STAY CLEAR OF BEATER IF
TRACTOR OR PTO IS RUNNING
BEATER SHUT OFF COULD
ACCIDENTALLY BE ENGAGED**

FAILURE TO HEED THIS
WARNING MAY RESULT IN
PERSONAL INJURY OR DEATH

KEEP CLOTHING, YOURSELF
AND OTHERS WELL CLEAR



1494B

⚠ WARNING

**DO NOT
REMOVE
SHIELDS
MOVING PARTS
INSIDE**

⚠ DANGER



NO STEP-STAY CLEAR

9194A

⚠ WARNING



**STAY
CLEAR**

1906C

SAFETY DECALS

	<p style="text-align: center;">! WARNING</p> <p style="text-align: center;">STAY CLEAR MOVING PARTS BEHIND THIS AREA</p>
---	--

1906E

! WARNING	
	<p style="text-align: center;">STAY CLEAR OF END GATE ARMS</p>

123002

	<p style="text-align: center;">! WARNING</p> <p style="text-align: center;">DOT NOT OPERATE THIS EQUIPMENT IF THIS DECAL IS EXPOSED. REPLACE SAFETY SHIELDS.</p>
---	--

71494A

! WARNING		
		
<p style="text-align: center;">CRUSHING HAZARD</p> <p style="text-align: center;">TO PREVENT SERIOUS INJURY OR DEATH:</p> <p style="text-align: center;">KEEP HANDS AND BODY OUT OF HITCH AREA WHEN ATTACHING TOWING VEHICLE.</p> <p style="text-align: center;">KEEP BODY CLEAR OF CRUSH POINT BETWEEN TOWING VEHICLE AND LOAD.</p> <p style="text-align: center;">KEEP FEET AND LEGS CLEAR FROM UNDER TONGUE AREA IN CASE OF POSSIBLE JACK FAILURE.</p>		

82602

	<p style="text-align: center;">! WARNING</p> <p style="text-align: center;">DO NOT OPERATE THIS EQUIPMENT IF THIS DECAL IS EXPOSED. REPLACE SAFETY SHIELDS. <u>FAILURE TO HEED MAY RESULT IN SERIOUS INJURY OR DEATH.</u></p>
---	---

51606

! WARNING	
<p>DO NOT OPERATE THIS EQUIPMENT IF THIS DECAL IS EXPOSED. REPLACE SAFETY SHEILDS.</p>	

32597A

	<p style="text-align: center;">! DANGER</p> <p style="text-align: center;">KEEP OUT</p> <p style="text-align: center;">DISENGAGE ALL POWER AND SHUT OFF TRACTOR ENGINE BEFORE ATTEMPTING TO ENTER OR CLEAN SPREADER</p> <p style="text-align: center;">FAILURE TO HEED THIS WARNING MAY RESULT IN PERSONAL INJURY OR DEATH</p>
---	--

1906F

! DANGER	
	<p style="text-align: center;">STAY CLEAR OF END GATE ARMS</p>

111593C

<p style="text-align: center;"><u>ATTENTION</u></p> <p style="text-align: center;">TRACTOR THREE POINT HITCH ARMS SHOULD BE REMOVED OR POSITIONED SO THEY CANNOT COME IN CONTACT WITH SPREADER. FAILURE TO HEED WILL CAUSE DAMAGE TO SPREADER AND VOID WARRANTY.</p>
--

71706

SAFETY INFORMATION

TRACTOR:

This operator's manual uses the term "Tractor" when identifying the power source.



TO PREVENT SERIOUS INJURY OR DEATH

BEFORE YOU ATTEMPT TO OPERATE THIS EQUIPMENT, READ AND STUDY THE FOLLOWING INFORMATION. IN ADDITION, MAKE SURE THAT EVERY INDIVIDUAL WHO OPERATES OR WORKS WITH THIS EQUIPMENT, WHETHER FAMILY MEMBER OR EMPLOYEE, IS FAMILIAR WITH THESE SAFETY PRECAUTIONS. KNOW HOW TO STOP UNLOADING MECHANISM BEFORE STARTING IT.

If the machine becomes clogged, disengage the PTO. Stop the tractor engine, remove ignition key, and allow all mechanisms to stop before cleaning or working on the machine.

"Never allow riders" in or on the machine.

DO NOT get off the tractor while the spreader is in operation.

DO NOT attempt to perform maintenance or repair with tractor running and PTO or hydraulic lines hooked up.

DO NOT step up on machine at any time.

NEVER manually feed material into the beaters.

DO NOT allow minors to operate or be near the machine.

DO NOT ALLOW PERSONNEL OTHER THAN THE QUALIFIED OPERATOR NEAR THE MACHINE.

Before starting tractor, be sure PTO shields turn freely and PTO is securely locked to tractor.

DO NOT clean, adjust, or lubricate the machine when any part is in operation.

Keep hands, feet, and clothing away from beaters when they are revolving.

Loose or floppy clothing should not be worn by the operator.

Be sure the machine is clear of people, tools, and other objects before engaging PTO.

DO NOT step over power take off shaft. Stay clear of PTO at all times.

NEVER start manure spreader until all guards and safety shields are secured in place.

STAY CLEAR of Hydraulic Lines. They may be under extreme pressure or heat.

H&S always takes the operator and their safety into consideration and guards exposed moving parts for their protection. However, some areas cannot be guarded or shielded in order to assure proper operation. In addition, the operators manual and decals on the machine itself warn you of further danger and should be read and observed closely.

Study The Above Safety Rules

ATTENTION - BE ALERT - YOUR SAFETY IS INVOLVED

CAP SCREW TORQUE VALUES

The specifications below are the torque values for fasteners as it adheres to the SAE torque value standards. All fasteners should be torqued to the proper values found in the figures below unless otherwise specified by the engineering drawing.

- Lubed torque would be any fastener that has grease, liquid Loctite, oil, etc. on the threads.
- Dry torque would be any fastener which has threads that are clean and dry and do not have any liquid Loctite or grease on them.

Hex Head Fasteners

The figure shown below shows how to determine what SAE grade a fastener is.

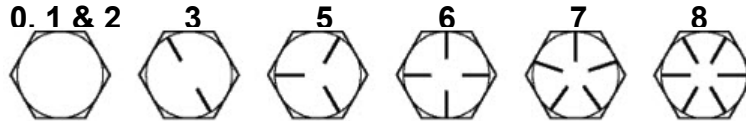

SUGGESTED ASSEMBLY TORQUE VALUES

WORKING TORQUE

	SAE GR. 2-6"		SAE GR. 5		SAE GR. 8		18-8 SS	316 SS	Brass	Silicon Bronze
Dia. & Thrds. per inch	Dry Ft. Lbs.	Lube Ft. Lbs.	Dry Ft. Lbs.	Lube Ft. Lbs.	Dry Ft. Lbs.	Lube Ft. Lbs.	Inch Lbs.	Inch Lbs.	Inch Lbs.	Inch Lbs.
1/4-20	5.5	4.2	8	6.3	12	9	75.2	78.8	61.5	68.6
1/4-28	6.3	4.7	10	7.2	14	10	94.0	99.0	77.0	87.0
5/16-20	11	8	17	13	24	18	132	138	107	123
5/16-28	12	9	19	14	27	20	142	147	116	131
3/8-16	20	15	30	23	45	35	236	247	192	219
3/8-24	23	17	35	25	50	35	259	271	212	240
7/16-14	32	24	50	35	70	50	376	393	317	349
7/16-20	36	27	55	40	80	60	400	418	327	371
1/2-13	50	35	75	55	110	80	517	542	422	480
1/2-20	55	40	85	65	120	90	541	565	443	502
9/16-12	70	55	110	80	150	110	682	713	558	632
9/16-18	80	60	120	90	170	130	752	787	615	697
5/8-11	100	75	150	110	210	160	1110	1160	907	1030
5/8-18	110	85	170	130	240	180	1244	1301	1016	1154
3/4-10	175	130	260	200	380	280	1530	1582	1249	1416
3/4-16	200	140	300	220	420	310	1490	1558	1220	1382
7/8-9	170	125	430	320	600	450	2328	2430	1905	2140
7/8-14	180	140	470	350	670	500	2318	2420	1895	2130
1-8	250	190	640	480	910	680	3440	3595	2815	3185
1-14	280	210	720	540	1020	760	3110	3250	2545	2885

HYDRAULIC FITTING TORQUE SPECIFICATIONS

Tapered Pipe Thread Size - Assembly turns from Finger Tight (TFFT) for Tapered Threads		TFFT
BSPT (Uncommon)	NPTF (Common)	
1/8-28	1/8-27	2 - 3
1/4-19	1/4-18	2 - 3
3/8-19	3/8-18	2 - 3
1/2-14	1/2-14	2 - 3
3/4-14	3/4-14	2 - 3
1-11	1-11 1/2	1.5 - 2.5
1 1/4-11	1 1/4-11 1/2	1.5 - 2.5
1 1/2-11	1 1/2-11 1/2	1.5 - 2.5
2-11	2-11 1/2	1.5 - 2.5



ORB - SAE J1926 Straight Thread Port Assembly Torques													
		Assembly Torque (+10% -0) **If fitting is being torqued into aluminum or brass, subtract 35% from standard torque value**											
		Non-Adjustable				Adjustable				Plugs			
		ORFS		JIC NPT		ORFS		JIC		Hollow Hex		Hex Head	
Dash Size	SAE Size (UN/UNF)	Ft. lbs. (In. lbs.)	Into Alum. Or Brass Ft. lbs. (in. lbs.)	Ft. lbs. (In. lbs.)	Into Alum. Or Brass Ft. lbs. (in. lbs.)	Ft. lbs. (In. lbs.)	Into Alum. Or Brass Ft. lbs. (in. lbs.)	Ft. lbs. (In. lbs.)	Into Alum. Or Brass Ft. lbs. (in. lbs.)	Ft. lbs. (In. lbs.)	Into Alum. Or Brass Ft. lbs. (in. lbs.)	Ft. lbs. (In. lbs.)	Into Alum. Or Brass Ft. lbs. (in. lbs.)
2	5/16-24	-	-	(85)	(55)	-	-	(60)	(39)	(30)	(19.5)	(85)	(55)
3	3/8-24	-	-	(155)	(101)	-	-	(100)	(65)	(55)	(36)	(155)	(101)
4	7/16-20	(310)	(201.5)	(260)	(169)	(180)	(117)	(180)	(117)	(120)	(78)	(260)	(169)
5	1/2-20	(360)	(234)	(280)	(182)	(360)	(234)	(250)	(162.5)	(170)	(110.5)	(280)	(182)
6	9/16-18	(420)	(283)	(350)	(227.5)	(420)	(273)	(350)	(227.5)	(410)	(266.5)	(350)	(175)
8	3/4-16	60	39	(620)	(403)	60	39	(620)	(217)	60	39	(620)	(403)
10	7/8-14	100	65	85	55	100	65	85	55.25	100	65	85	55
12	1 1/16-12	135	88	135	88	135	88	135	88	135	88	135	88
14	1 3/16-12	175	114	175	114	175	114	175	114	175	114	175	114
16	1 5/16-12	200	130	200	130	200	130	200	130	200	130	200	130
20	1 5/8-12	250	162.5	250	162.5	250	162.5	250	162.5	250	162.5	250	162.5
24	1 7/8-12	305	198	305	198	305	198	305	198	305	198	305	198
32	2 1/2-12	375	244	375	244	375	244	375	244	375	244	375	244

HYDRAULIC FITTING TORQUE SPECIFICATIONS

Code 61 and 62 Flange Recommended Bolt Torques

Steps to Properly Assemble the Flange Port Clamping Bolts:

1. Inspect components to ensure that male and female port threads and sealing surfaces are free of burrs, nicks and scratches, or any foreign material.
2. Lubricate the O-ring
3. Position flange and clamp halves
4. Place lock washers on bolts and insert through clamp halves
5. Hand tighten bolts.
6. Torque bolts in diagonal sequence in small increments to the appropriate torque level **refer to the table below.

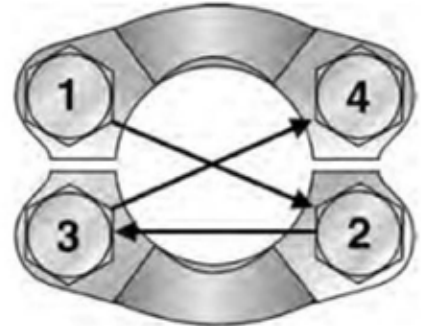

Flange Bolt Tightening Sequence

Code 61						Code 62					
Dash Size	Flange Size	Inch Bolt (SAE J518)	Torque ft. lbs.	Metric Bolt (ISO 6162)	Torque N-m	Dash Size	Flange Size	Inch Bolt (SAE J518)	Torque ft. lbs.	Metric Bolt (ISO 6162)	Torque N-m
8	1/2	5/16-18	17 ± 2	M8	24	8	1/2	5/16-18	17 ± 2	M8	24
12	3/4	3/8-16	31	M10	50	12	3/4	3/8-16	31	M10	50
16	1	3/8-16	31 ± 4.5	M10	50	16	1	7/16-14	52	M12	92
20	1-1/4	7/16-14	52	M12	92	20	1-1/4	1/2-13	77	M14	130
24	1-1/2	1/2-13	77	M12	92	24	1-1/2	5/8-11	155	M16	210
32	2	1/2-13	77	M12	92	32	2	3/4-10	265	M20	400
40	2-1/2	1/2-13	77	M12	92						
48	3	5/8-11	155	M16	210						
56	3-1/2	5/8-11	155	M16	210						
64	4	5/8-11	155	M16	210						
80	5	5/8-11	155	M16	210						

37° Flare (JIC) Assembly Torques and FFWR					
SAE Dash Size	Thread Size	Assembly Torque (+10%-0)		Tube Connection FFWR	Swivel Nut or Hose Connection FFWR
		In. lb.	ft. lb.		
-2	5/16-24	35	3	-	-
-3	3/8-24	65	5	-	-
-4	7/16-20	155	13	2 1/2	2
-5	1/2-20	165	14	2	2
-6	9/16-18	265	22	2	1 1/2
-8	5/8-16	505	42	2	1 1/2
-10	7/8-14	720	60	1 1/2	1 1/2
-12	1 1/16-12	1000	84	1 1/2	1 1/4
-14	1 3/16-12	1200	100	1 1/2	1 1/4
-16	1 5/16-12	1415	118	1 1/2	1
-20	1 5/8-12	2015	168	1	1
-24	1 7/8-12	2340	195	1	1
-32	2 1/2-12	3180	265	1	1
-40	3-12	-	-	1	1

SET-UP & ASSEMBLY



WARNING: Some photographs used in the following pages show guards or shields removed for clarification. Never operate machine until these guards or shields are in proper operating position.

NOTE: Determine right or left side of the Manure Spreader by viewing it from the rear. If instructions or parts lists call for hardened bolts, refer to the Cap Screw Torques Value page to identify.

PREPARING MANURE SPREADER

The Manure Spreader may be shipped without the wheels/tires installed.

1. Attach the wheels with tires, using the lug nuts furnished and torque the mounting hardware to the appropriate torque. Wheel bolts should be tightened at 100 ft/lbs. of torque on the 4242 and 300 ft/lbs. of torque on the 4255.
2. Check the tires and inflate to the recommended pressure.
(425/65R-22.5 tires to 85 psi)
(19L x 16.1 tires to 32 psi)
(600/50R-22.5 tires to 38 psi)
3. Check for proper assembly and adjustment and make sure that all bolts are tightened.
4. Securely retighten after a few hours of operation, as bolts can loosen up on new machinery.
5. Lubricate the machine completely, check the oil level of the gearbox, fill if necessary. Check the automatic oiler level if spreader is equipped, fill if necessary.

TRANSPORTING

TRANSPORT LIGHTING & REFLECTORS

When transporting on the highway, connect the spreader to the tractor with a lighting power cord. The lighting system is to be connected to the 7 pin power receptacle (per SAEJ560B) on your tractor. If your tractor is not equipped with the proper receptacle, see your tractor dealer for details. Make sure lights are functioning properly. Regularly clean the reflective tape at the rear of the spreader. There is a holder provided for your SMV sign.

SAFETY CHAIN (Optional)

Follow state and local regulations regarding use of a safety chain and transport lighting when towing farm equipment on public highways. A proper safety chain should be used to retain the safety connection between the towing and towed machines, in the event of separation of the primary attaching system. Check with local law enforcement agencies for your own particular regulations. Unless otherwise prohibited, use a slow-moving vehicle emblem. Never tow the manure spreader on a public highway at a speed greater than 20 mph (32 kph).

1. The chain is sufficiently slack to allow turns and movements of either the tractor or the manure spreader, without placing tension on the chain.
2. The chain is of sufficient strength to hold the decoupled implement (and its load) and tow it to the shoulder.

PREPARING FOR OPERATION

TRACTOR CONNECTIONS

Tractor Hitch

ATTENTION: Remove tractor quick coupler (if equipped). Tractor three point arms should be removed or positioned so they cannot come in contact with spreader. **Failure to heed will cause damage to spreader and Void Warranty.**

Fasten the spreader hitch to the drawbar with a **hitch pin with a safety locking device**. Use 1-1/2" diameter hitch pin to pull spreader. Remove the weight from the jack (jack is not to be used when spreader is loaded). Remove jack from pipe mount and place on convenient storage mount located on the side of the left push frame brace. This allows protection of jack from tractor tires during turns. The hitch of the spreader is designed for a standardized tractor hitch. Adjust the drawbar so that it is 13 to 17 inches above the ground. Extend or shorten it so that the horizontal distance from the end of the tractor power takeoff shaft to the center of the hitch pin hole is 14 inches for 540 PTO and 15-3/4" for 1000 PTO as shown in drawing. An improperly located hitch point may cause damage to the universal joints of the power takeoff. Secure the drawbar so that the hitch pin hole is directly below the power drive line.

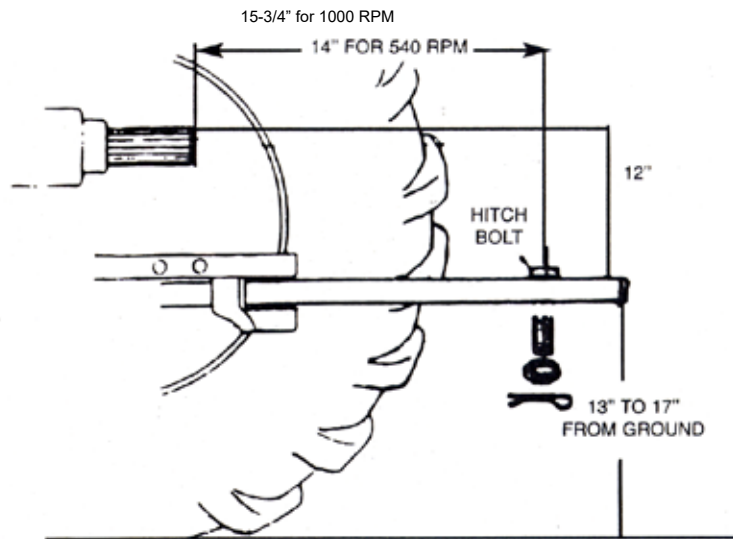

Hydraulics

The spreader requires a 4-hose hook-up;

1. Connect the set of hydraulic hoses which operate the Manure Spreader hydraulic push gate from the spreader to a double acting valve on the tractor.
2. Connect the set of hydraulic hoses which operate the hydraulic endgate to another double acting valve on the tractor.
3. **The hydraulic endgate must be raised completely prior to activating hydraulics for pusher.**
4. Operate the tractor valve to fill the hydraulic lines and operate the cylinders. Add hydraulic fluid to the tractor system, as required.

Note: Before operation, run the machine slowly to make sure that the Manure Spreader is operating and lubricated properly.

PREPARING FOR OPERATION

PTO ASSEMBLY

Attach the PTO of the spreader to the tractor by sliding the spring loaded locking collar on PTO yoke rearward, then sliding it onto the tractor PTO shaft. Release spring loaded collar. Be sure the pins fall into the groove of the tractor PTO shaft and collar snaps forward into locking position.

CAUTION: Do not use a steel hammer to aid in joining PTO parts.

Keep the male and female driving elements well lubricated and free sliding. Failure to observe this precaution will result in excessive pressure being required to collapse or extend the assembly while subject to operating torque. This excessive force may damage or displace the main shaft bearings. DO NOT lubricate the shield surfaces. The shield surfaces must be kept dry, as dirt accumulation on them will quickly cause these units to bind and not rotate. Be sure that the rotating integral shields are not dented or damaged, as this also will result in excessive force being applied against the jackshaft. Damaged shields also cause obvious difficulties when installing the assembly. If at any time the shields do not turn freely, they should be checked to determine the cause, and repaired or cleaned. To avoid damage to the main drive bearings, avoid turning sharp corners while PTO is running. Start and Stop PTO slowly to avoid damage to the drive line.

If this implement is attached to a tractor with a clevis hitch (hammer-strap) style drawbar, the hammer-strap must be removed to prevent damage to the IID guarding and the IID telescoping members. [See Figure 1]

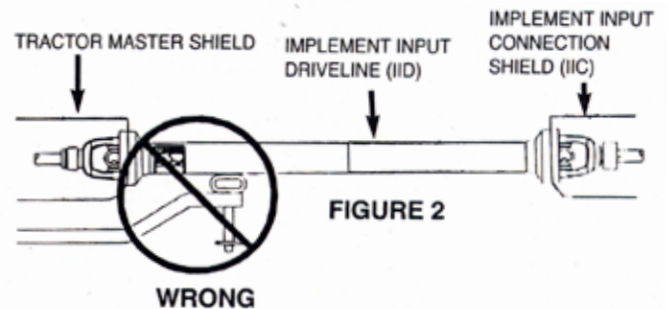
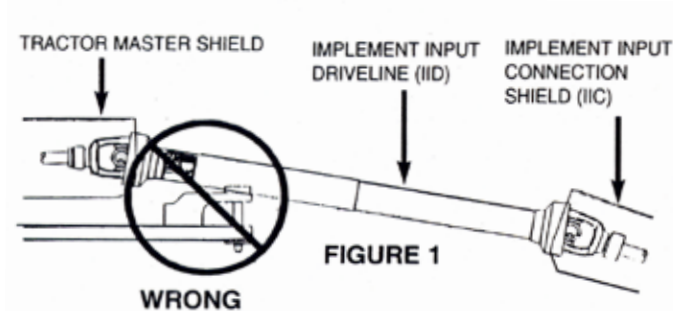

If this implement is attached to a tractor with an offset in the drawbar, be certain it is in the down position to prevent damage to the IID guarding and the IID telescoping members. [See Figure 2]

Before operation, run machine slowly to make sure that the spreader is operating and lubricated properly.

OPERATION

EMERGENCY SHUTDOWN

If a foreign object becomes lodged in the beater area and shears the shear bolt, disengage the PTO and stop the hydraulic pusher. Stop the tractor engine, remove the ignition key, and allow all mechanisms to stop before cleaning or working on the spreader.

LOADING

Begin loading the spreader at the front end and work toward the rear until loading is completed. Loading this way permits the material to be spread uniformly. Loading front to rear is particularly important when the spreader is loaded by a mechanical loader because this type of load requires more power to spread than other loads.

When hauling extremely heavy materials with a large portion of dirt, it may be necessary to reduce the loadsize to prevent excessive shear bolt breakage. Never dump material onto the beater. Do not use extra sideboards. Do not overload spreader. Overloading decreases spreading effectiveness. Do not load more than 15 inches above the horizontal beater unit.

WINTER OPERATION

In freezing weather, make certain that hydraulic tailgate is not frozen to the sides or on the floor of the spreader. Make sure the push gate is not frozen to the spreader floor or any lumps of manure are frozen to the floor.

SPREADING

1. Engage the tractor PTO slowly. Beater is always in the engaged position, therefore, engaging the tractor PTO will automatically start the beaters.
2. Raise the hydraulic endgate by engaging the tractor hydraulics. **Note: Hydraulic endgate MUST BE RAISED COMPLETELY prior to engaging hydraulic pushgate.**
3. Engage the tractor hydraulic lever into the detent position to operate the spreader hydraulic pusher.
4. The spreader pusher hydraulic hose has a restrictor in the line. It can easily be slowed down by the tractor flow control if tractor is equipped with one (optional in-line flow control is available.)
5. When the spreader is empty, disengage the tractor PTO (which will stop the beater). Engage the tractor hydraulics to return the spreader push gate. When the spreader push gate is **completely retracted**, engage tractor hydraulics to close hydraulic endgate.

SERVICING

Be certain to disconnect all sources of power before servicing. Keep pant cuffs and loose clothing away from all chains and drives as well as the other moving parts. Keep off the equipment when in use, and keep all shields in place. Do not attempt to clean, grease or lubricate while the machine is running.

Never allow riders in or on the machine.

DRIVELINE PROTECTION TORQUE LIMITER DISCONNECT CLUTCH

The driveline is protected by a Torque Limiter Disconnect Clutch located in the PTO driveline before the gearbox of the spreader. Disconnect of the clutch during operation is normally due to large frozen chunks of manure, foreign objects (rocks, chunks of wood etc.) in the manure, running the spreader push gate too fast when unloading long straw and pen-packed material, or STARTING THE SPREADER PTO TOO QUICKLY WITH HIGH TRACTOR RPM. Always determine the reason for the disconnect and eliminate the problem before re-engaging the PTO.

BEATER

When replacing the beater paddles (Horizontal Beater Assembly), the sharp edges of the teeth must lead in the direction of beater travel. On the right half of the beater the teeth must point to the right side of the spreader. On the left half of the beater the teeth must point to the left side of the spreader. Always use H&S special grade 5 bolts, washers, and nuts when replacing tips and torque to 60 foot lbs.

ADJUSTMENTS

HORIZONTAL BEATER DRIVE CHAINS

Both beater drive chains can be adjusted by loosening bolts (A) and sliding the poly tensioners toward the chain until 1/2" of deflection can be obtained on the opposite side (B). Retighten the bolts (A) when deflection is obtained.

NOTE: PERIODICALLY LUBRICATE ALL ROLLER CHAINS WITH A LIGHT MACHINE OIL.

BE SURE ALL SHIELDS ARE SECURED INTO PLACE PRIOR TO RESTARTING MACHINE.

Shields Opened
for Clarity

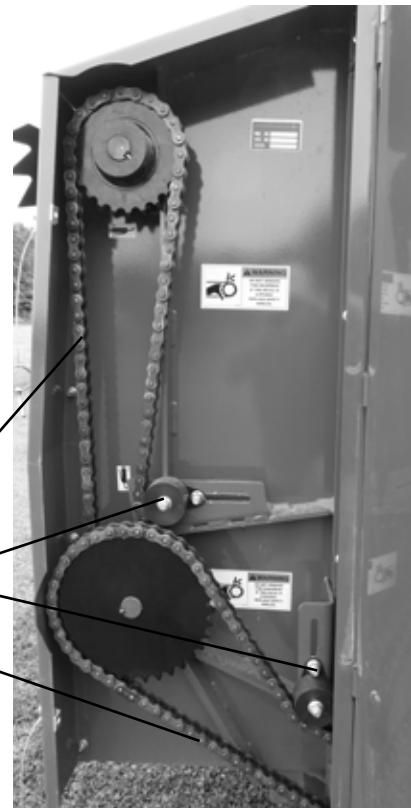

**FAILURE TO FOLLOW THE RECOMMENDED
ADJUSTMENTS WILL VOID WARRANTY.**

WHEEL HUBS

To adjust the wheel hubs, tighten the castellated nut on the spindle to the point where there is no end-play and a slight drag on the bearings. Replace the cotter key with a new one of the correct size.

VERTICAL BEATERS

BEATER REMOVAL

The beater attachment can easily be removed for various reasons such as manure stock piling.

1. Remove bolts, nuts and lockwashers at the same location on each side (A).
2. Disconnect the quick disconnect PTO from the gearbox under the rear of the manure spreader and remove the rear half of the PTO.
3. The remaining portion of the rear PTO has a roll pin that must be removed to slide the front portion of the PTO from the shaft.
4. After removal of both PTO halves, slide them together and store them in a safe place.
5. Securely attach a lifting chain to the lifting eyes at the top of the beater assembly (B).
6. Lift the beater assembly gently until alignment pegs are clear of the alignment holes.
7. Store the beater assembly on level ground with blocking as not to damage the drive system.



TIMING OF BEATERS

The beaters must be timed so the flighting of the opposite beater is about halfway between the beater being timed. If the beaters are not timed correctly, contact your H&S dealer for timing instructions.

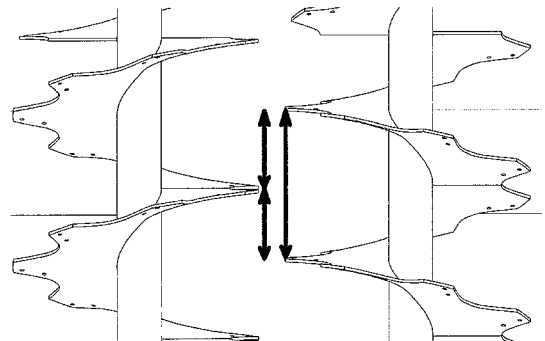

OPTIONAL EQUIPMENT

REAR PAN - HORIZONTAL BEATER

The rear pan shown to the right is optional equipment on the 4242 & 4255 spreader. The rear pan option allows for an even spread when light applications are needed.

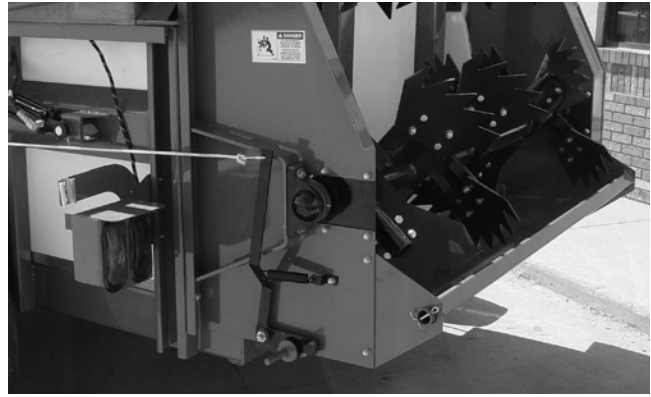

FIT-A-ROUND SCREEN EXTENSION - VERTICAL BEATER

An optional Fit-a-Round Screen Extension is available on vertical beater models to protect you and the tractor from any flying material when turning a corner.



MANUAL ADJUST HYDRAULIC VARIABLE SPEED PUSHER CONTROL

The optional manual adjust valve allows you to adjust your pusher speed if the tractor is not equipped with a variable speed on the flow control.

ELECTRIC ADJUST HYDRAULIC VARIABLE SPEED PUSHER CONTROL

The optional electric adjust valve allows you to adjust your pusher speed from the tractor cab if the tractor is not equipped with a variable speed on the flow control.

LUBRICATION GUIDE

GENERAL INFORMATION

IMPORTANT: *Catch and dispose of fluid per local waste disposal regulations whenever service is performed on hydraulic components, valves, cylinders, hoses, etc.*

The operator should become familiar with all lubrication points and establish a systematic routine to ensure complete and quick lubrication of the machine.

GREASING

There are numerous grease fittings on the spreader. If these are lubricated properly and often enough, it will prolong the life of the spreader. (Grease every 20 hours, **also before and after power washing.**) Make certain that the grease fittings are free of paint and dirt, force a high-quality grease into them until the grease comes out around the shaft on the sleeve-type bearings. On the sealed ball bearings, grease should be added slowly until a slight bead forms at the seals indicating the correct amount of lubricant. Wipe off excess grease to prevent the accumulation of chaff and grit around the bearings.

PTO ASSEMBLY

Keep the male and female driving elements well lubricated and free sliding. Failure to observe this precaution will result in excessive pressure being required to collapse or extend the assembly while subject to operating torque. This excessive force may damage or displace the main shaft bearings. DO NOT lubricate the shield surfaces. The shield surfaces must be kept dry, as dirt accumulation on them will quickly cause these units to bind and not rotate. Be sure that the rotating integral shields are not dented or damaged, as this also will result in excessive force being applied against the jackshaft. Damaged shields also cause obvious difficulties when installing the assembly. If at any time the shields do not turn freely, they should be checked to determine the cause, and repaired or cleaned. To avoid damage to the main drive bearings, avoid turning sharp corners while PTO is running. Start and Stop PTO slowly to avoid damage to the drive line.

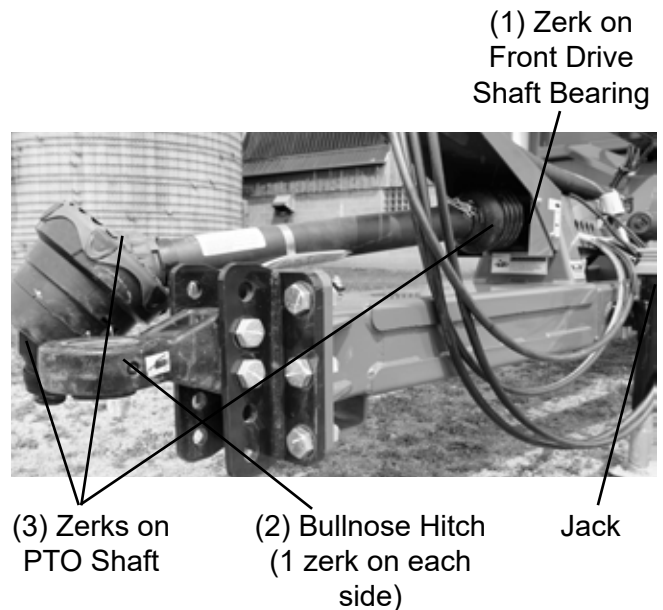

GEARBOX LUBRICATION

There are (2) different gearboxes that may be used on a Hydra-Push manure spreader; BERMA or OMNI. See the respective images to locate the fill, check, and drain points on the gearbox that you have on your Hydra-Push manure spreader.

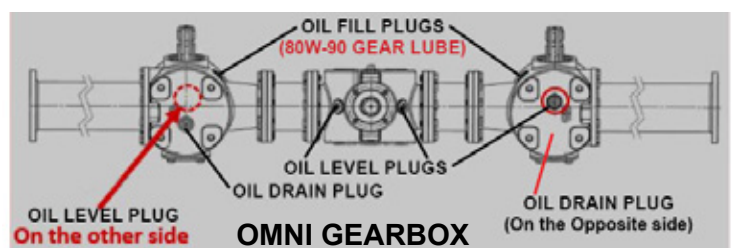
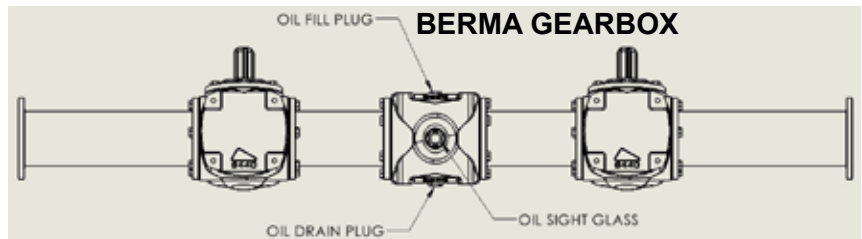

LUBRICATION GUIDE

(1) Zerk on each side for hydraulic end gate pivot



Vertical Beater Models

(2) Zerks - one for each bearing on the top of the vertical beaters

(2) Zerks on Torque Limiting Clutch (Drive-line PTO in rear under spreader VB model)

(1) Zerk on each hub on all wheels

(2) Remote zerks for the main drive shaft bearings under the spreader

(2) Remote zerks - one for each tandem axle pivot

HORIZONTAL BEATER GEARBOX

Before using your new Manure Spreader, check the oil in the beater drive gearbox. Keep the gearbox filled to the oil plug on the side of the gearbox as shown with Mobilube SHC 75W90 (or equivalent) gear lube.

CHECK PLUG

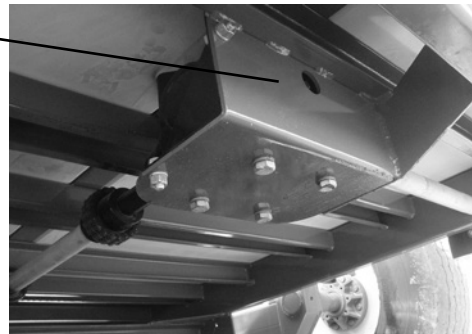

(Gearbox is located underneath rear of spreader)

(4) Zerks
(1) on the end of each Beater
The R.H. zerks are under the shield

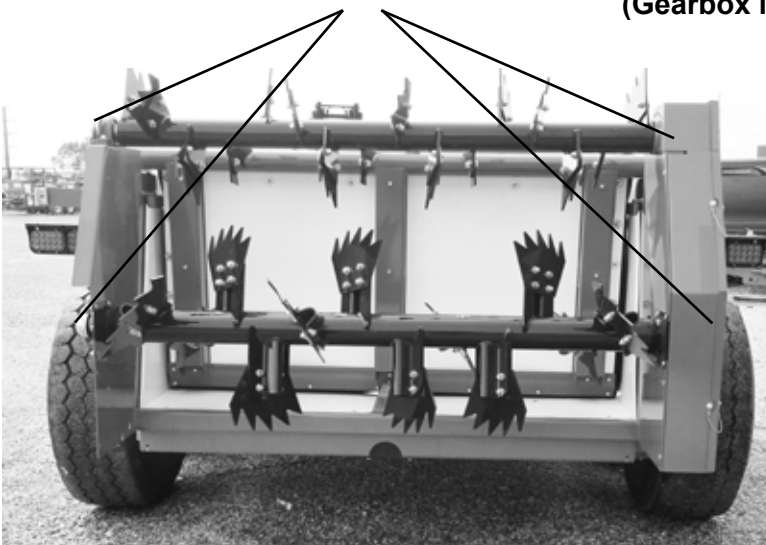

Shields Removed for Clarity

Zerk Behind Shield on bearing)



(2) Zerks on Overrunning Clutch (HB model)

DECAL LOCATION

Your H&S Manure Spreader was manufactured with operator safety in mind. Located on the manure spreader are various decals to aid in operation, and warn of danger or caution areas. Pay close attention to all decals on your Manure Spreader.



DO NOT REMOVE ANY OF THESE DECALS. IF DECALS ARE LOST, DAMAGED, OR IF MANURE SPREADER IS REPAINTED, REPLACE DECALS. REMEMBER: DECALS ARE FOR YOUR PROTECTION AND INFORMATION.

Listed below are the decals on your Manure Spreader. These decals may be ordered individually by part number or by ordering a complete set.

<u>PART #</u>	<u>QTY</u>	<u>DESCRIPTION</u>
311	1	Patent Number
1494A	2	Warning - Do Not Operate
1494B	1	Warning - Do Not Remove Shields
1494J	3	Warning - Do Not Clean or Work
1494K	1	Warning - Do Not Remove Shields
1494L	1	Danger - Rotating Driveline
1906C	2	Warning - Stay Clear
1906D	2	Danger - Stay Clear
1906E	2	Warning - Stay Clear
1906F	5	Danger - Keep Out
3494A	1	Remote Grease Fitting
71494A	1	Warning - Do Not Remove Shields(Only on Vertical Beater Spreader)
67130	1	Hydra Push Spreader Decal - HP4242/HP4255 Left Side
67131	1	Hydra Push Spreader Decal - HP4242/HP4255 Right Side
67132	1	Hydra Push Spreader Decal - HP4242/HP4255 Front
71233	2	Model Decal - 4242 Left and Right Side
71232	1	Model Decal - 4255 Left and Right Side
71237	1	Model Decal - 4242 Front
71236	1	Model Decal - 4255 Front
9194B	1	Danger - Never Allow Riders
9194A	6	Danger - No Step
11599	3	Warning - Stay Clear of Leaks
12794	2	Warning - Do Not Operate
32597A	1	Warning - Do Not Operate
51606	1	Warning - Do Not Operate
54033	1	Made in USA 3"
58703	1	Danger - Stay Clear of Beater
71188B	1	Jack Storage Position
71706	1	Attention - Tractor 3pt Hitch
72203A	1	Warning - Help Avoid Injury
82602	2	Warning - Crushing Hazard
84044	1	FEMA
86060	2	Danger - Stay Clear of Beater
98305	1	Notice - Cold Weather Operation
093020	10	Grease Fitting
111510	1	Attention Return Pusher
111593A	2	Danger - Stay Clear of Beater
111593C	2	Warning - Stay Clear of Endgate
123002	2	Warning - Stay Clear of Endgate
DCAMB	6	Amber Reflector
DCRED	2	Red Reflectors
JD5922	2	Orange Non Reflective Decal
FEMA	1	Decal - Fema

DECAL LOCATION

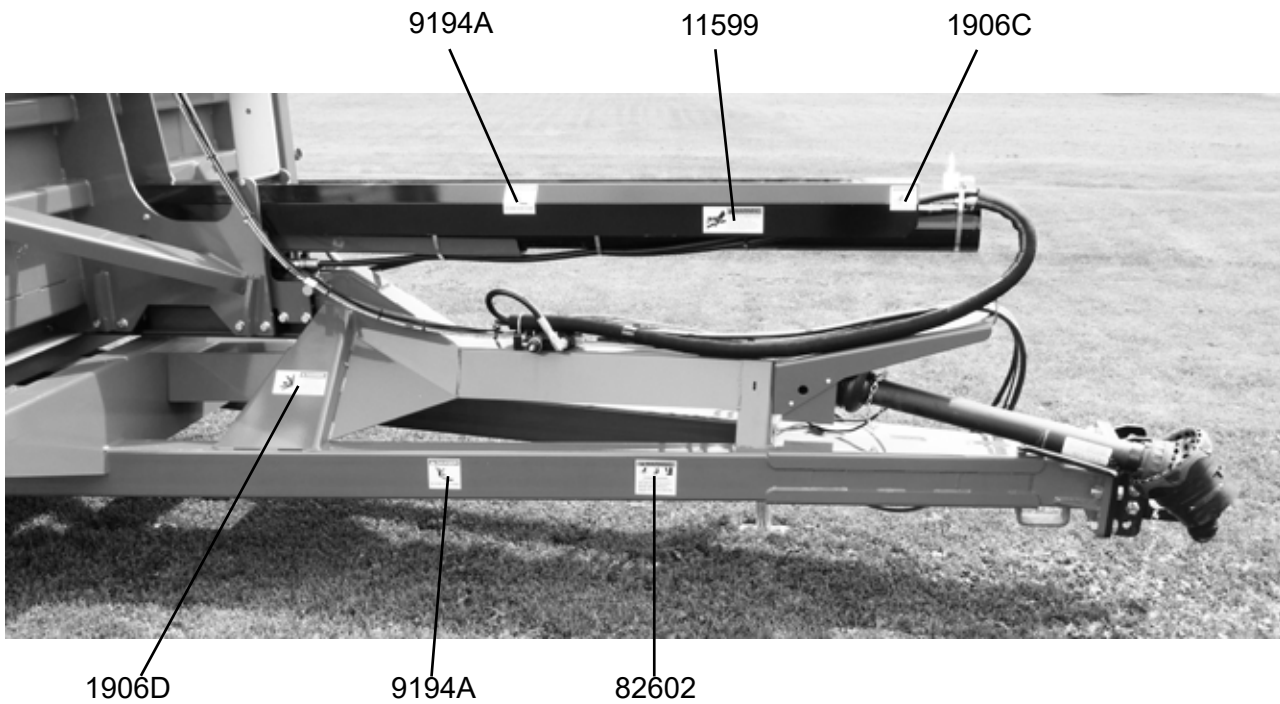
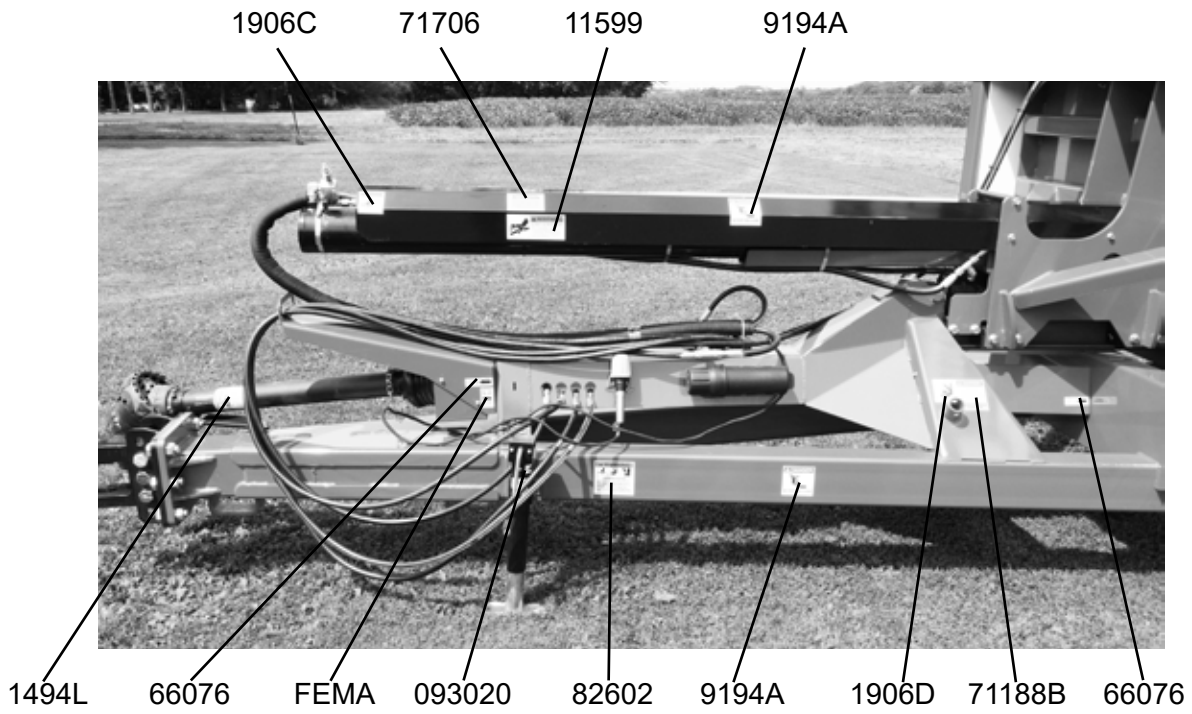

DECAL LOCATION

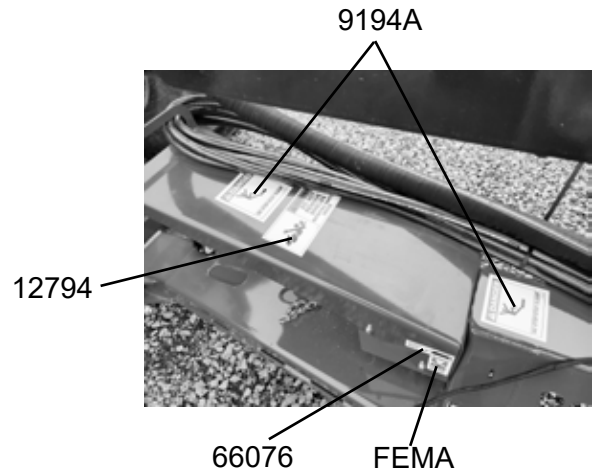
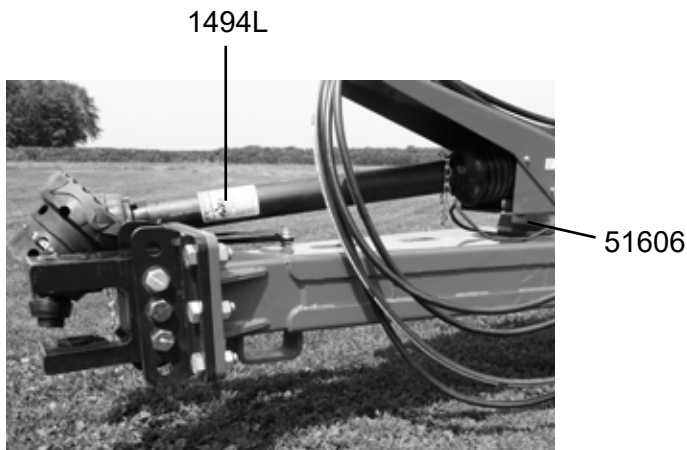
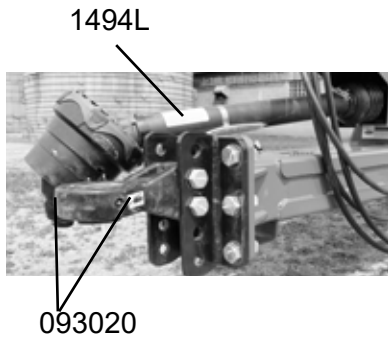
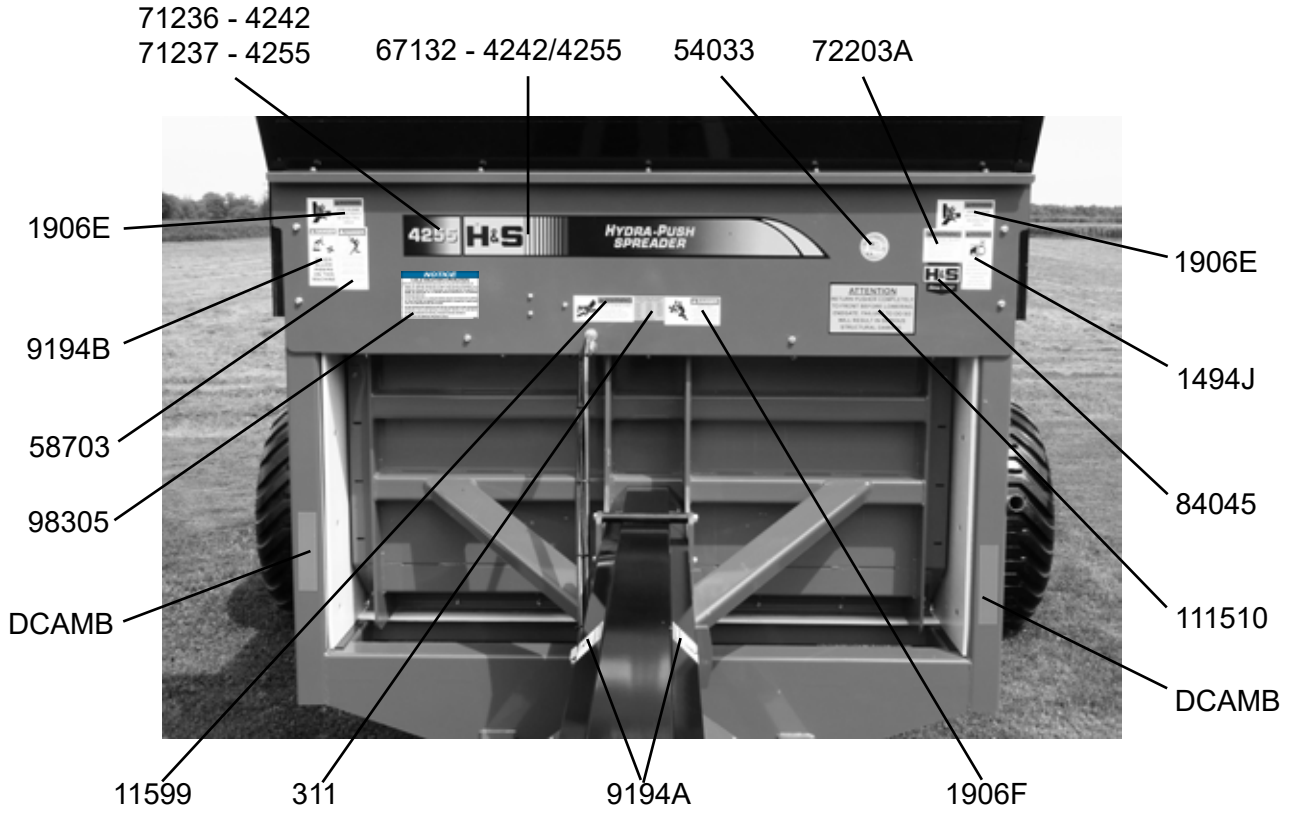

DECAL LOCATION

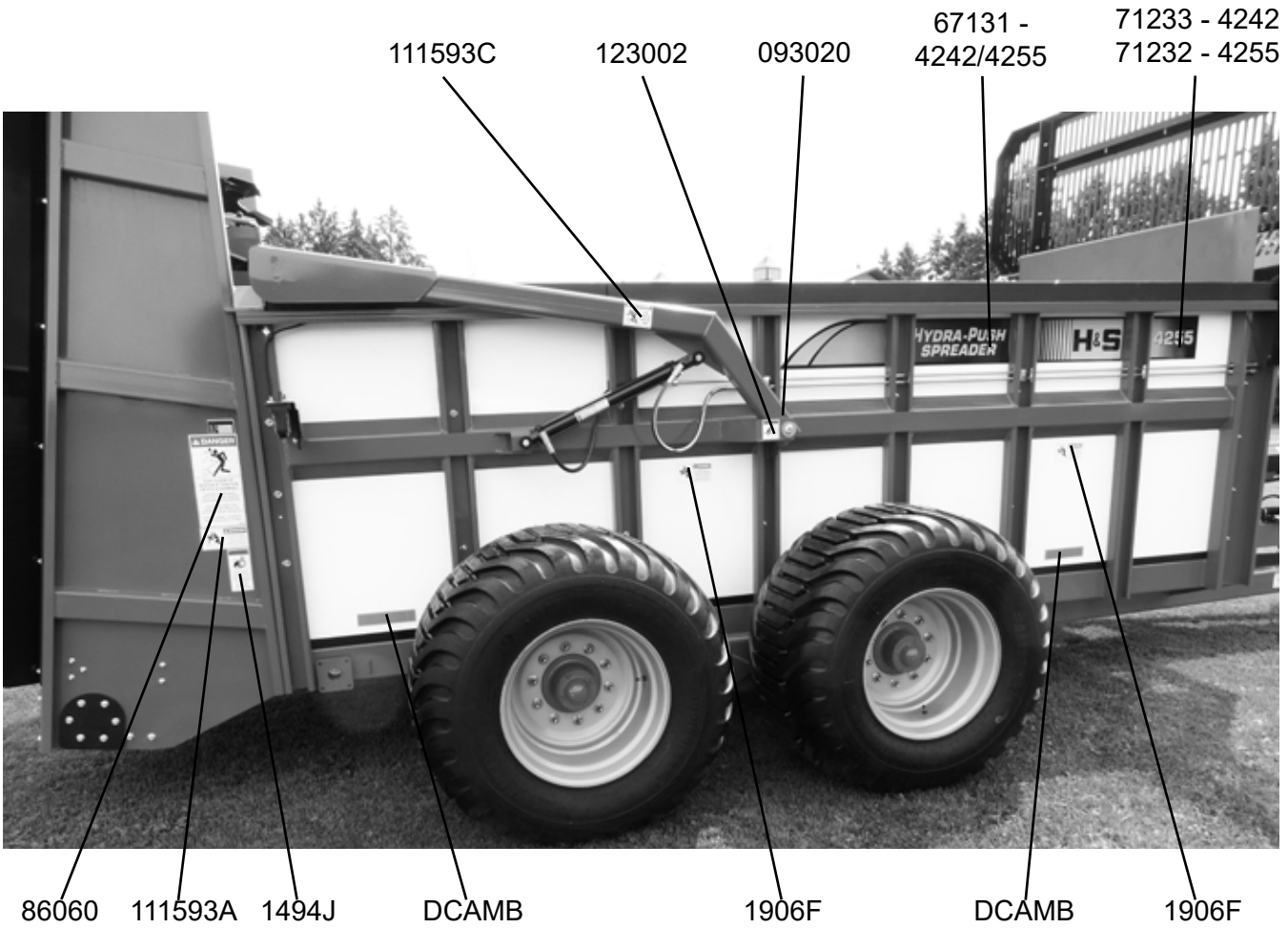

71494A
 UNDER
 SHIELD

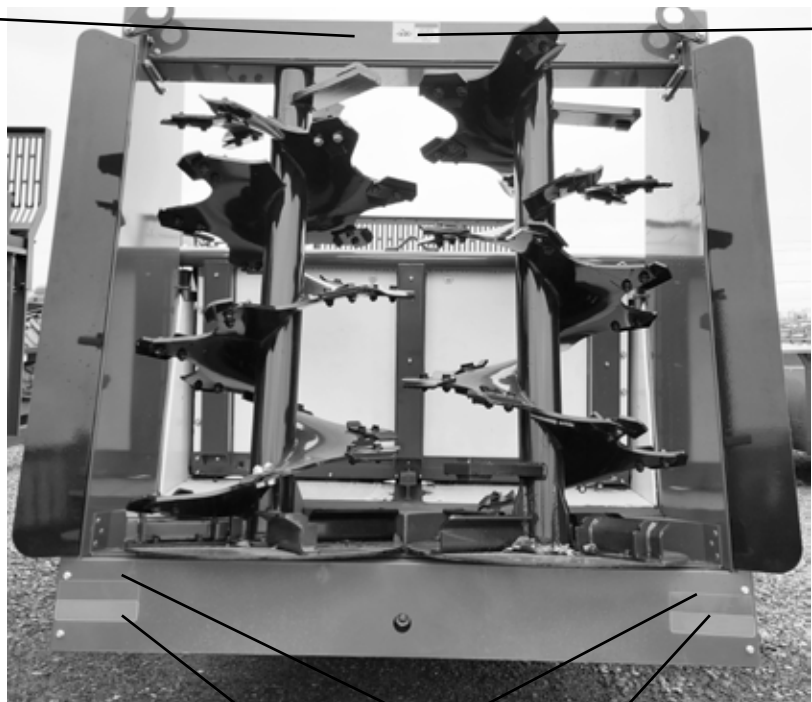

DECAL LOCATION

71233 - 4242
71232 - 4255

67130 - 4242/4255

093020

123002

111593C



1906F

DCAMB

1906F

DCAMB

1494J

86060

REMOTE GREASE

11593A

DECAL LOCATION - HORIZONTAL BEATER

425 & 550 Bushel



DCAMB

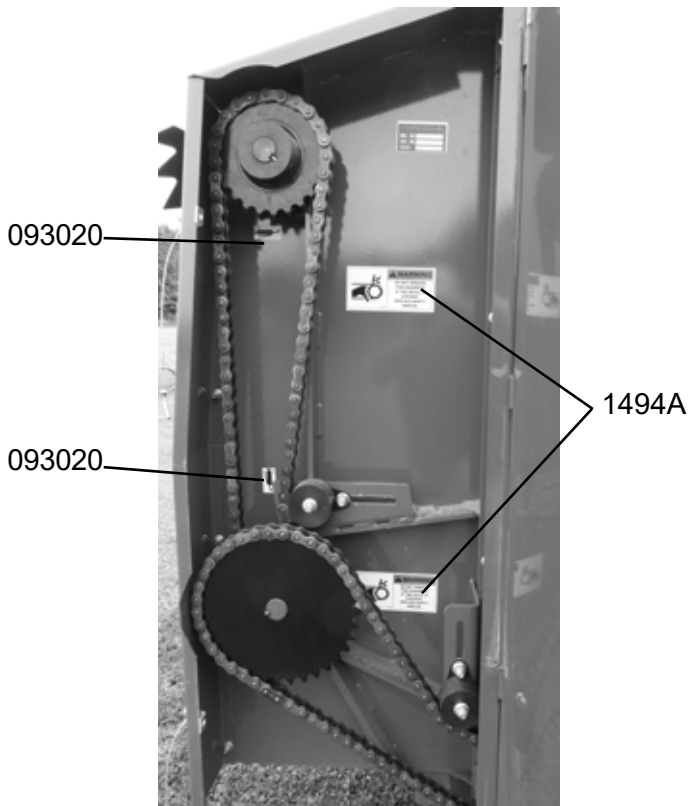
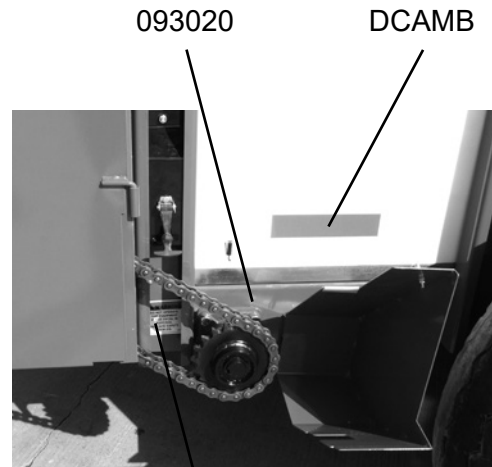

32597A

DECAL LOCATION - HORIZONTAL BEATER

550 Bushel

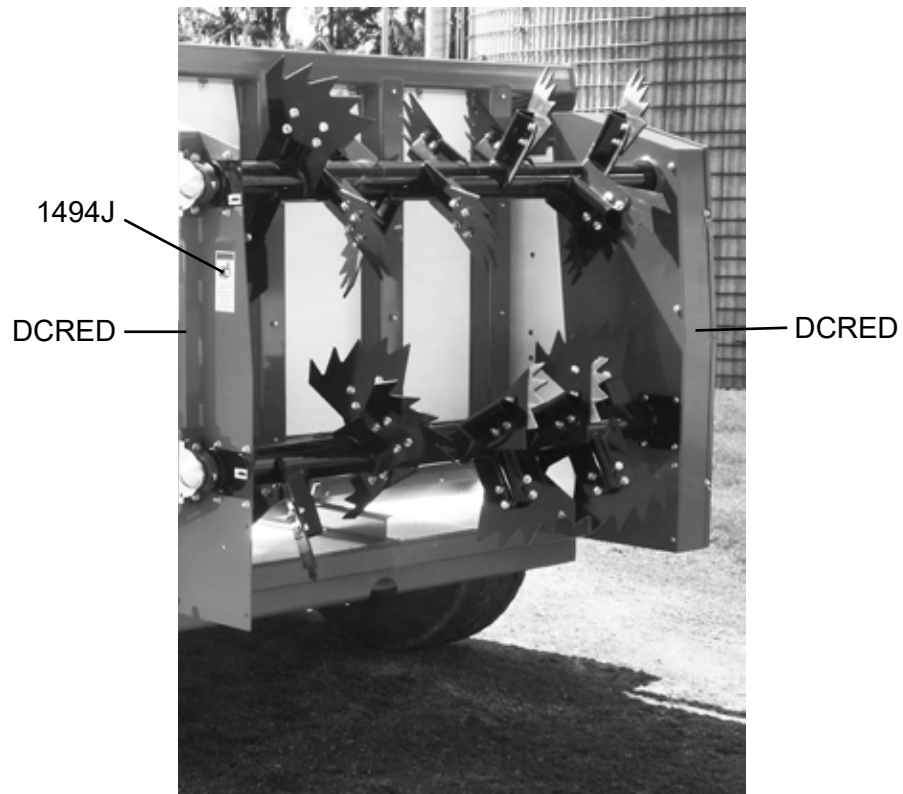
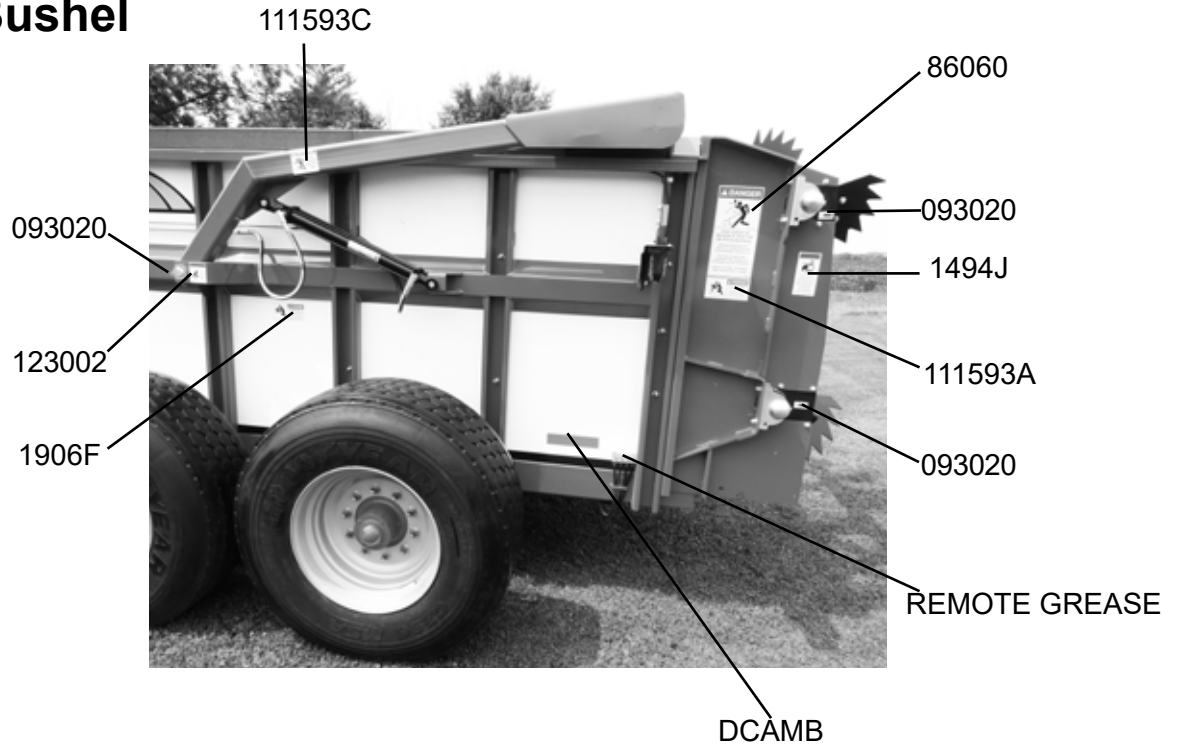

DECAL LOCATION

425 Bushel

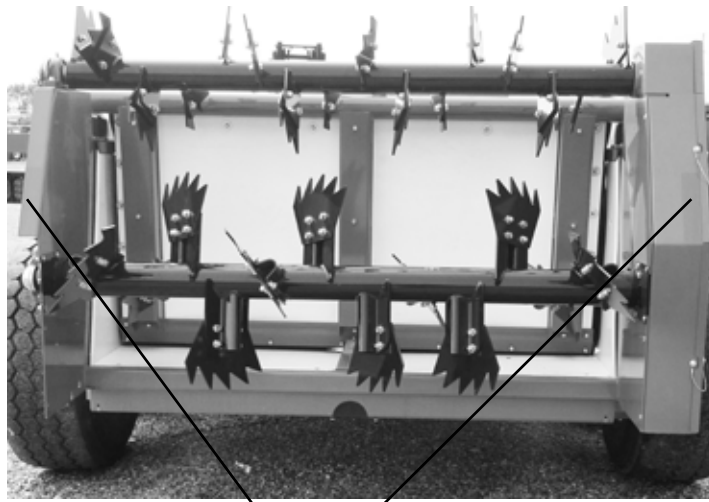

DCRED

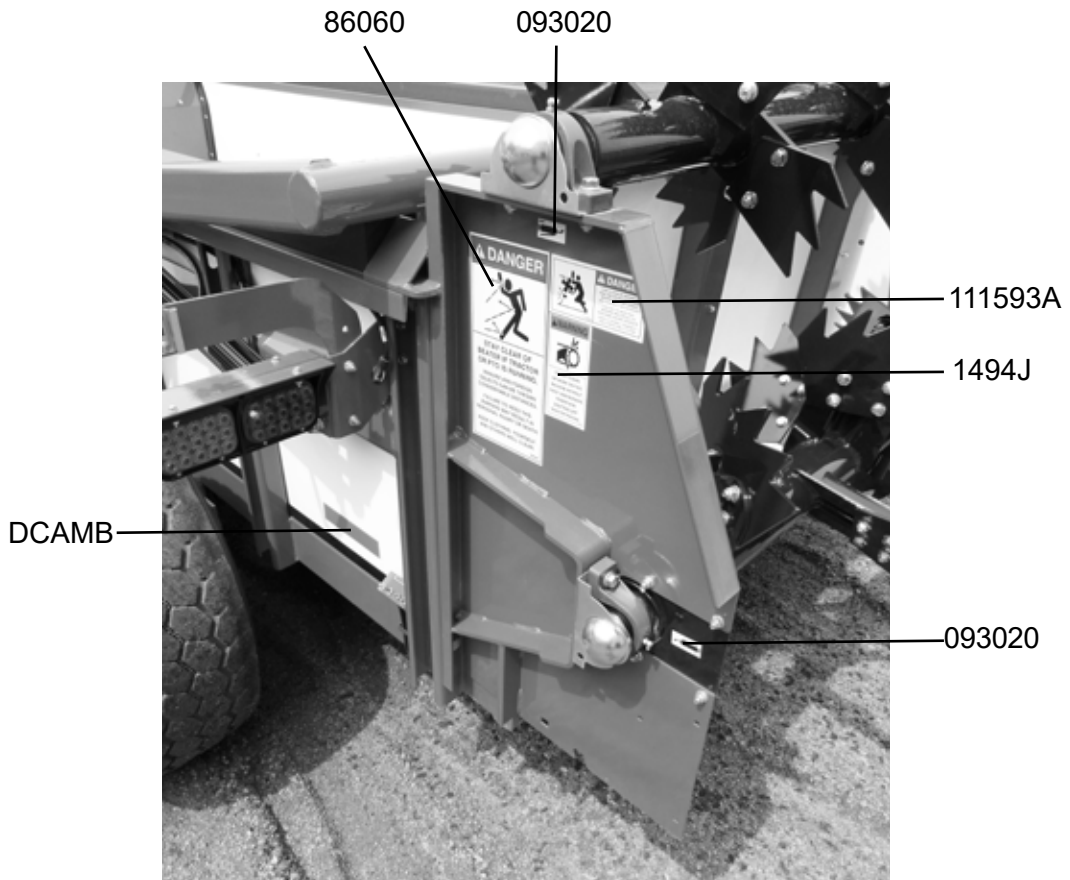

TROUBLESHOOTING



WARNING:

MAKE SURE THAT THE TRACTOR IS SHUT OFF AND THE SPREADER CANNOT MOVE BEFORE SERVICING THE MANURE SPREADER. MAINTENANCE AND REPAIR SERVICE WORK TO BE PERFORMED BY A QUALIFIED SERVICE PERSON ONLY.

TROUBLE...	POSSIBLE CAUSE...	POSSIBLE REMEDY...
Beater Will Not Run	Tractor PTO Not Turning	Engage Tractor PTO
	Primary Beater Drive Chain Off, Broken or Missing - (HB)	Replace or Repair Primary Beater Drive Chain
	Key Sheared or Missing on Beater Drive or Driven Sprocket	Replace Sheared or Missing Key
Top Beater Does Not Turn	Secondary Beater Drive Chain Off, Broken or Missing	Replace or Repair Secondary Beater Drive Chain
Push Gate Will Not Move	Tractor Hydraulics Not Engaged	Engage Tractor Hydraulics
	Low Tractor Hydraulic Flow or Pressure	Have Servicing Dealer Check Tractor Flow And Pressure
	Hydraulic Couplers Not Coupled To Tractor Properly	Couple Hoses To Tractor
	Spreader Is Over Loaded	Reduce Load

H&S MFG. CO.

products approved

for the

FEMA

SEAL OF QUALITY



Manufactured by:

H&S MANUFACTURING CO., INC.

2608 S. HUME AVE. MARSHFIELD, WI 54449

(715) 387-3414 | hsmfco.com

