

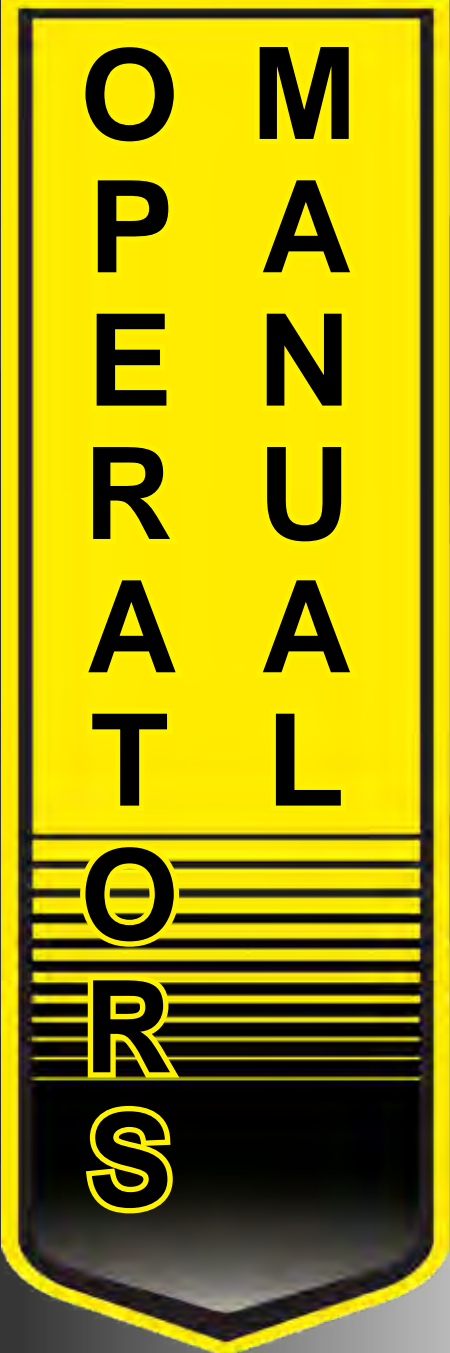

LW1100 LINEWRAP



WARNING

READ AND UNDERSTAND THIS MANUAL BEFORE OPERATING THIS EQUIPMENT. UNSAFE OPERATION OR MAINTENANCE OF THIS EQUIPMENT CAN RESULT IN SERIOUS INJURY OR DEATH.

Starting Serial #911LW11021

Part#78782

Rev. #01

HSMFG0519

STRONG HERITAGE - STRONG PEOPLE - STRONGER FUTURE

CONTENTS

Warranty	1
Manufacturer's Statement	2
Warranty Registration Form	3
Dealer Pre-Delivery Checklist	5
Dealer Delivery Checklist	7
Safety Information - Be Alert Symbol	9
Safety Information - Explanation of Safety Signs	10
Safety Decals	11-12
Safety Information - Warning - Owner Must Read and Understand	13-14
Cap Screw Torque Values	15
Set-Up & Assembly	16
Transporting	17
Preparing for Operation	18
Operation	19-24
Service & Adjustments	25-26
Optional Equipment	27
Lubrication Guide	28-29
Decal Location	30-34
Troubleshooting	35-37
Service Notes	38
Specifications	Inside Back Cover

H&S WARRANTY

H&S Manufacturing Co., Inc. ("H&S") warrants this product to be free from defect in material and workmanship. Except as noted below, this warranty term is twelve (12) months on labor, and twenty-four (24) months on parts from the date of delivery of the product to the original purchaser by an authorized H&S dealer. Under this warranty, H&S will repair or replace, at its option, any covered part which is found to be defective in material or workmanship during the applicable warranty term. In no case will the covered repair cost of a part or parts exceed the replacement cost of that part. Warranty service must be performed by H&S or a dealer authorized by H&S to sell and/or service the product involved, which will use only new or remanufactured parts or components furnished by H&S. This warranty includes approved parts and labor to fix the product but does not include, and the purchaser is responsible for, any service call and/or transportation of the product to and from the dealer's place of business, for any premium charged for overtime labor requested by the purchaser, and for any service work not directly related to any defect covered under this warranty. This warranty includes only those components of the product manufactured by H&S. Warranty for any component not manufactured by H&S including, but not limited to, engines, batteries, tires, rims, hydraulic motors, pumps, etc. are covered by the warranty, if any, provided separately by their respective manufacturers.

This warranty in all its parts, is extended solely to the original purchaser of the product, is terminated upon any subsequent transfer or sale from or by the original purchaser and extends no third party benefits or rights whatsoever.

The warranty term for any product used in any commercial, custom, for hire or rental application, is limited to six (6) months from the date of delivery of the product to the original purchaser or the first day of service, whichever comes first, by an authorized H&S dealer.

For commercial, custom for hire, or rental application, warranty is limited to 6 months from the date of delivery to the original purchaser, or the first day in service, whichever is earlier.

This warranty does not include: (1) Any product that has been altered or modified in ways not approved by H&S; (2) Depreciation or damage caused by normal wear, use for which the product was not designed, misuse, improper or insufficient maintenance, improper operation, accident or failure to follow the product Operator's Manual recommendations and product decal recommendations; (3) Normal maintenance parts and service; (4) Repairs made with parts other than those available from H&S or performed by anyone other than H&S or a dealer authorized by H&S to sell and/or service the product involved.

To secure warranty service the purchaser must report the product defect to a dealer authorized by H&S to sell and/or service the product involved within the applicable warranty term together with evidence of the warranty start date and make the product available to that dealer within a reasonable period of time.

THERE ARE NO WARRANTIES WHICH EXTEND BEYOND THE DESCRIPTION ON THE FACE OF THIS WARRANTY. H&S and the companies affiliated with it makes no warranties, representations, or promises, express or implied, as to the performance or freedom from defect of its products other than those set forth above and **NO IMPLIED WARRANTY OF MERCHANTABILITY, FITNESS OR FITNESS FOR A PARTICULAR PURPOSE IS MADE. IN NO EVENT WILL THE DEALER, H&S OR ANY COMPANY AFFILIATED WITH H&S BE LIABLE FOR INCIDENTAL OR CONSEQUENTIAL DAMAGES.** The **ONLY REMEDY** the purchaser has in connection with the breach of performance of any warranty on H&S products are those set forth above.

The selling dealer has no authority to make any representation or promise on behalf of H&S, or to modify the terms or limitations of this warranty in any way.

11/14/18

MANUFACTURER'S STATEMENT

Your New H&S Product has been manufactured of the finest quality materials and components. The performance you get from your machine is largely dependent upon how well you read and understand this manual and apply this knowledge. There is a right and a wrong way to do everything. Please do not assume that you know how to operate and maintain your Machine before reading this manual carefully. Keep this manual available for ready reference.

H&S reserves the right to make changes or add improvements to its products at any time without incurring any obligation to make such changes to products previously manufactured. Specifications, statements and descriptions of Products contained in this publication are subject to change without prior notification.

WARRANTY REGISTRATION

- ❖ Date of Purchase: _____
- ❖ Purchaser Name: _____
- ❖ Street Address: _____
- ❖ City: _____
- ❖ State: _____ Zip: _____
- ❖ Phone Number: _____
- ❖ E-mail Address: _____
- ❖ Product: _____
- ❖ Model Number: _____
- ❖ Serial Number: _____
- ❖ You have received the Operators Manual for this product. Yes _____ No _____

Interested in receiving the H&S Newsletter? Yes _____ No _____

- ❖ Dealer Name: _____
- ❖ Street Address: _____
- ❖ City: _____
- ❖ State: _____ Zip: _____
- ❖ Signature: _____

❖ *All fields must be filled out to insure prompt notification of product and/or warranty updates.*

Please mail the completed WARRANTY REGISTRATION FORM to:
H&S Manufacturing Co., Inc.
2608 S. Hume Ave.
Marshfield, WI 54449

(Remove Copy At Perforation)

Intentionally Left Blank

DEALER PRE-DELIVERY CHECKLIST

AFTER COMPLETION, DEALER SHOULD REMOVE AND RETAIN FOR RECORDS

After the LINEWRAP has been completely set up, check to be certain it is in correct operating order before delivering to the customer. The following is a list of points to inspect. Check off each item as you have made the proper adjustments and found the item operating satisfactorily.

- LINEWRAP was not damaged in shipment. Check for dents and loose or missing parts. Report damage immediately to H&S Manufacturing Co., Inc.
- LINEWRAP has been correctly assembled according to instructions in this manual.
- All bolts and fasteners are tight.
- All Shields and Guards are in place and fastened.
- All grease fittings have been lubricated. See Lubrication Chapter of this manual for details.
- Hoses and fittings are properly attached and there are no visible leaks.
- All mechanisms are operating trouble free.
- Hydraulic fluid reservoir is filled to proper level.
- Wheels are properly mounted and wheel nuts are tightly secured.
- Tires are inflated to correct pressure.
- Decals are in place and legible.

Model Number _____

Serial Number _____

Dealer's Name _____

Inspection Date _____

Signature of Pre-Delivery Inspector _____

(Remove Dealers File Copy At Perforation)

Intentionally Left Blank

DEALER DELIVERY CHECKLIST

AFTER COMPLETION, DEALER SHOULD REMOVE AND RETAIN FOR RECORDS

This checklist that follows is an important reminder of valuable information that should be passed on to the customer at the time that this Machine is delivered.

Check off each item as you explain it to the customer.

This delivery checklist, when properly filled out and signed, assures the customer that the pre-delivery service was satisfactorily performed.

- Explain to the customer that the pre-delivery inspection was made.
- Explain to the customer all the safety precautions they must exercise when operating this unit.
- Explain the recommended settings for different types of bales.
- Explain to customer that regular lubrication is required for proper operation and long life of machine.
- Show customer the lubrication section of Owner's Manual.
- Give the customer Owner's Manual and make sure they read and understand all operating and service instructions.
- Have the customer sign a completed "Warranty Registration" and mail it.

Date Delivered _____

Dealer's Name _____

By _____

Signature of Original Buyer _____

Note: Warranty is not valid until warranty card is completed and returned to H&S Mfg. Co., Inc.

Intentionally Left Blank

SAFETY INFORMATION



**BE
ALERT!**

**YOUR SAFETY
IS INVOLVED.**

THIS SYMBOL IS USED THROUGHOUT THIS BOOK WHENEVER YOUR PERSONAL SAFETY IS INVOLVED. TAKE TIME TO BE CAREFUL. REMEMBER: THE CAREFUL OPERATOR IS THE BEST OPERATOR. MOST ACCIDENTS ARE CAUSED BY HUMAN ERROR. CERTAIN PRECAUTIONS MUST BE OBSERVED TO PREVENT THE POSSIBILITY OF INJURY OR DAMAGE.

H&S MANUFACTURING CO., INC.

SAFETY INFORMATION

Keep signs in good condition. Immediately replace any missing or damaged signs.

RECOGNIZE SAFETY INFORMATION

This is the safety alert symbol. When you see this symbol on your machine or in this manual, be alert to the potential for personal injury.

Follow recommended precautions and safe operating practices.



UNDERSTAND SIGNAL WORDS

A signal word - DANGER, WARNING, or CAUTION - is used with the safety alert symbol. DANGER identifies the most serious hazards.

Safety signs with signal word DANGER or WARNING are typically near specific hazards.

General precautions are listed on CAUTION safety signs.



WARNING



CAUTION



FOLLOW SAFETY INSTRUCTIONS

Carefully read all safety messages in this manual and all safety signs on your machine. Follow all recommended precautions and safe operating procedures.

OBSERVE MAXIMUM TRANSPORT SPEED

The maximum transport speed for this implement is 32 km/h (20 mph).

Some tractors are capable of operating at speeds that exceed the maximum transport speed of this implement. Regardless of the maximum speed capability of the tractor being used to tow this implement, do not exceed the implement's maximum transport speed.

Exceeding the implement's maximum transport speed can result in:

- * Loss of control of the tractor/implement combination
- * Reduced or no ability to stop during braking
- * Implement tire failure
- * Damage to the implement structure or its components

Use additional caution and reduce speed when towing under adverse surface conditions, when turning, and when on inclines.

Do not attempt transport if the fully loaded implement weighs more than 1.5 times the weight of the tractor.



SAFETY INFORMATION

 WARNING	TO PREVENT SERIOUS INJURY OR DEATH NEVER OPERATE THIS UNIT UNLESS EMERGENCY STOP FUNCTIONS PROPERLY <small>5896C</small>
--	--

WARNING	
HELP AVOID INJURY	
<ul style="list-style-type: none">• READ & UNDERSTAND THE OPERATORS MANUAL PROVIDED WITH THIS MACHINE. IF MISPLACED CALL H & S MANUFACTURING AT 715-387-3414 WITH MODEL AND SERIAL NUMBER.• UNDERSTAND ALL SAFETY WARNINGS AND FUNCTION OF CONTROLS.• KEEP SAFETY DEVICES IN PLACE AND WORKING.• KEEP YOURSELF AND OTHERS WELL CLEAR OF MOVING PARTS.• DISCONNECT ALL POWER BEFORE SERVICING OR CLEANING THIS MACHINE.• DO NOT EXCEED 20 MPH <small>72203A</small>	

	WARNING DO NOT OPERATE THIS EQUIPMENT IF THIS DECAL IS EXPOSED. REPLACE SAFETY SHIELDS. <small>32597D</small>
---	---

 <small>32597C</small>	DANGER SHUT ENGINE COMPLETELY OFF BEFORE ADJUSTING OR SERVICING MACHINE. MACHINE MAY START UNEXPECTEDLY FAILURE TO HEED THIS WARNING MAY RESULT IN PERSONAL INJURY OR DEATH
--	--

SAFETY INFORMATION

 <p>32597B</p>	<p>⚠ DANGER</p> <p>STAY CLEAR OF TAIL SECTION IN RAISED POSITION</p> <p>FAILURE TO HEED THIS WARNING MAY RESULT IN PERSONAL INJURY OR DEATH</p>
---	--

	<p>⚠ WARNING</p> <p>DO NOT GO NEAR LEAKS</p> <ul style="list-style-type: none">• High pressure oil easily punctures skin causing serious injury, gangrene or death.• If injured, seek emergency medical help. Immediate surgery is required to remove oil.• Do not use finger or skin to check for leaks.• Lower load or relieve hydraulic pressure before loosening fittings. <p>11599</p>
---	--

<p>⚠ WARNING</p>

<p>DO NOT REMOVE SHIELDS MOVING PARTS INSIDE</p> <p>32597E</p>

<p>⚠ WARNING</p>
<p>DO NOT OPERATE THIS EQUIPMENT IF THIS DECAL IS EXPOSED. REPLACE SAFETY SHEILDS.</p> <p>32597A</p>

SAFETY INFORMATION



W A R N I N G

TO PREVENT SERIOUS INJURY OR DEATH

BEFORE YOU ATTEMPT TO OPERATE THIS EQUIPMENT, READ AND STUDY THE FOLLOWING INFORMATION. IN ADDITION, MAKE SURE THAT EVERY INDIVIDUAL WHO OPERATES OR WORKS WITH THIS EQUIPMENT, WHETHER FAMILY MEMBER OR EMPLOYEE, IS FAMILIAR WITH THESE SAFETY PRECAUTIONS.

DO NOT ALLOW PERSONNEL OTHER THAN THE QUALIFIED OPERATOR NEAR THE MACHINE.

Stop the machine, remove key, and allow all mechanisms to stop before cleaning, working, or adjusting on machine.

BE SURE to read and understand engine owner/operator manual supplied with this machine.

PRIOR TO starting engine, check to make sure all guards are in place and all persons are clear of the machine. **DO NOT** attempt to perform maintenance or repair with engine running.

ALWAYS shut engine completely off before extending or retracting last bale push off mechanism. Machine may start unexpectedly.

CHECK EMERGENCY STOP mechanism frequently to insure that it is operating properly.

DO NOT step up on machine at any time.

DO NOT allow minors to operate or be near the machine.

Loose or floppy clothing should not be worn by the operator.

Stay clear of hydraulic lines, they may be under extreme pressure or heat.

ALWAYS engage the brake prior to operating the wrapper, retract the brake prior to transport.

NEVER tow the LINEWRAP at speeds over 20 mph.

H&S always takes the operator and his safety into consideration and guards exposed moving parts for their protection. However, some areas cannot be guarded or shielded in order to assure proper operation. In addition, the operators manual and decals on the machine itself warn you of further danger and should be read and observed closely.

Study The Above Safety Rules
ATTENTION - BE ALERT - YOUR SAFETY IS INVOLVED

SAFETY INFORMATION



WARNING

TO PREVENT SERIOUS INJURY OR DEATH NEVER OPERATE THIS UNIT UNLESS THE EMERGENCY STOP FUNCTIONS PROPERLY

Your H&S Linewrap is equipped with an electric emergency stop switch. This switch is activated by the stop cable. Activating the emergency stop will stop all functions of the machine. The engine will continue to run.



IF THE EMERGENCY STOP IS TRIPPED DURING WRAPPING CYCLE, THE UNIT MUST BE SWITCHED TO MANUAL OPERATION ON THE CONTROL PANEL. PRESS THE START/RESET SWITCH, THEN PRESS AND HOLD THE MANUAL PUSHER AND HOOP SWITCHES TO BEGIN WRAPPING AGAIN. WHILE HOLDING SWITCHES, SELECT THE DESIRED MODE, AUTOMATIC OR REMOTE ON THE CONTROL BOX TO CONTINUE NORMAL OPERATION.

If the optional remote handset is used, the emergency stop may be activated by pressing the emergency stop button in either the Automatic or Remote Modes.



CAP SCREW TORQUE VALUES

The specifications below are the torque values for fasteners as it adheres to the SAE torque value standards. All fasteners should be torqued to the proper values found in the figures below unless otherwise specified by the engineering drawing.

Lubed torque would be any fastener that has grease, liquid Loctite, oil, etc. on the threads.

Dry torque would be any fastener which has threads that are clean and dry and do not have any liquid Loctite or grease on them.

Hex Head Fasteners

The figure shown below shows how to determine what grade a fastener is.

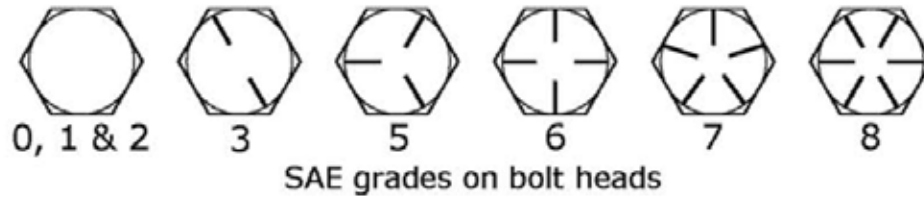

	SUGGESTED ASSEMBLY TORQUE VALUES						WORKING TORQUE			
	SAE GRADE 2 -6"		SAE GRADE 5		SAE GRADE 8		18-8 SS	316 SS	BRASS	SILICON BRONZE
Diam & Thrds Per Inch	Dry FT. LB.	LUB FT. LB.	Dry FT. LB.	LUB FT. LB.	Dry FT.LB.	LUB FT. LB.	IN LBS	IN LBS	IN LBS	IN LBS
1/4-20	5.5	4.2	8	6.3	12	9	75.2	78.8	61.5	68.6
1/4-28	6.3	4.7	10	7.2	14	10	94.0	99.0	77.0	87.0
5/16-18	11	8	17	13	24	18	132	138	107	123
5/16-24	12	9	19	14	27	20	142	147	116	131
3/8-16	20	15	30	23	45	35	236	247	192	219
3/8-24	23	17	35	25	50	35	259	271	212	240
7/16-14	32	24	50	35	70	50	376	393	317	349
7/16-20	36	27	55	40	80	60	400	418	327	371
1/2-13	50	35	75	55	110	80	517	542	422	480
1/2-20	55	40	85	65	120	90	541	565	443	502
9/16-12	70	55	110	80	150	110	682	713	558	632
9/16-18	80	60	120	90	170	130	752	787	615	697
5/8-11	100	75	150	110	210	160	1110	1160	907	1030
5/8-18	110	85	170	130	240	180	1244	1301	1016	1154
3/4-10	175	130	260	200	380	280	1530	1582	1249	1416
3/4-16	200	140	300	220	420	310	1490	1558	1220	1382
7/8-9	170	125	430	320	600	450	2328	2430	1905	2140
7/8-14	180	140	470	350	670	500	2318	2420	1895	2130
1-8	250	190	640	480	910	680	3440	3595	2815	3185
1-14	280	210	720	540	1020	760	3110	3250	2545	2885

SET-UP & ASSEMBLY

NOTE: Determine right or left side of the LINEWRAP by viewing it from the rear. If instructions or parts lists call for hardened bolts, refer to Cap Screw Torque Values chart.

1. Assemble the LINEWRAP and check for proper assembly and adjustment. Make sure that all bolts are tightened.
2. Attach the wheels with tires, using the lug nuts furnished and torque the mounting hardware to 80 ft./lbs. of torque. Check wheel bolts periodically thereafter.
3. Check tires and inflate to the recommended pressure. (11L x 15 to 36 pounds)
4. Check the hydraulic oil level of the reservoir tank. Fill to the full level if needed (See Lubrication Chapter in this manual).
5. Lubricate the LINEWRAP completely (See Lubrication Chapter in this manual).

TRANSPORTING

TOWING ON HIGHWAY

Follow state and local regulations when towing farm equipment on public highways. Never tow the LINEWRAP on a public highway at a speed greater than 20 mph (32 kph).



REFLECTORS

Decals are on the Linewrap for safety, an SMV bracket, red and amber reflective safety decals. Refer to the [Decal Placement Chapter](#) for location.

PREPARING FOR OPERATION

1. The battery must be fully charged before operation.

NOTE: THE RED BATTERY DISCONNECT KEY MUST BE IN THE OFF POSITION AND REMOVED BEFORE CHARGING OR THE CONTROL BOARD COULD BE DAMAGED.

2. Fill the gas tank with gas and check the engine oil level. Fill to full level if needed.

3. Start the engine, let it idle for a short period of time to warm up.

4. Release the tail/ramp hydraulic locking valve while keeping the manual lock bar connected.

5. Activate the hydraulic control lever to pressurize the tail/ramp system.

6. Disconnect the tail/ramp lock bar and rotate it forward to the storage position.

Note: Stand aside of the tail/ramp when disconnecting the lockbar in case there is an air pocket in the system that would allow the tail/ramp to fall back upon removal.



Tail/Ramp Hydraulic Locking Valve

7. Activate the hydraulic control lever to lower the tail/ramp. Cycle the ramp up and down a few times to remove any air pockets. Turn the wheel brake valve to the upright or off position, lower the ramp and the wheel brake will set.

8. Turn the wheel brake valve to the straight or on position - this will release the wheel brake. Raise the tail/ramp, replace lock bar and close the tail/ramp hydraulic locking valve.

9. Activate the Start/Reset switch on the control box by pushing up and releasing. This switch must always be activated before any functions of the control box will operate.

10. Place the Mode switch in the manual position and operate the functions of the wrapper.

11. Place the Mode switch in the automatic position and push the bale trip bar down in the front of the machine to check for proper operation. When the pusher contacts the first electronic switch, the hoop should engage. Upon contact with the second switch, the hoop should stop and the pusher return to the home position.

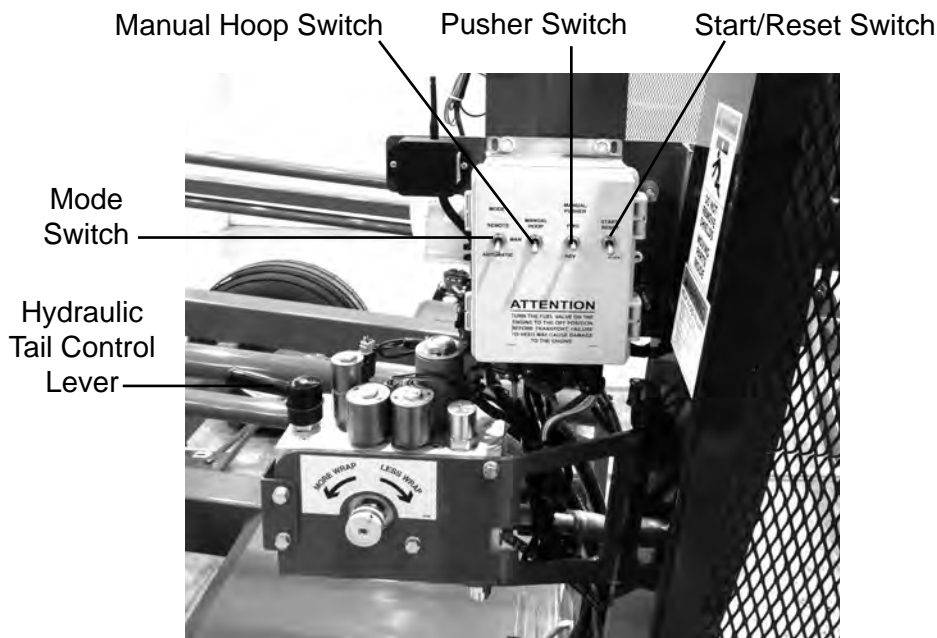

OPERATION

PLACING WRAPPER IN POSITION

If possible, place the LINEWRAP in a north/south facing direction. This will allow minimal freezing to the bales in the winter as the sun works from east to west. After placing in position, shorten the tongue into the steering position by lifting the spring loaded telescoping lock pin and sliding the telescoping tongue in. Once the tongue has been retracted, the tongue can be pinned to the hand crank or hydraulic steer mechanism. Steering will enable the machine to be guided around contours or along fence lines.

INSTALLING PLASTIC FILM

To install plastic film on the machine, shut off engine, and open side shield on the engine side of machine. Rotate the hoop upward by hand until the first pre-stretcher is accessible. Note that there are two different ways to put the roll on the machine as shown by the decal. The tack side of the film should always be to the bale side of the film. The tack side of the film can be on either side and can be determined by folding the film together inside to inside or outside to outside. Whichever side pulls apart harder is the tack side of the film. With the film correctly mounted, route the film through the pre-stretcher as shown in the decal. Go to the other side of the machine, open the shield and repeat the process described above to install the second roll of plastic film.



**Always shut engine
off before making
adjustments.**

BALE GUIDES

Adjust the bale guides so they are a couple of inches wider than the diameter of the size of bales to be wrapped. These guides are used to keep the bales centered while wrapping. **DO NOT** load bales onto the guides. Improper use of the guide may result in damage to the machine. Adjustment can be made by removing 4 pins, 2 rear and 2 front, rotating the bale guides and replacing the pins.

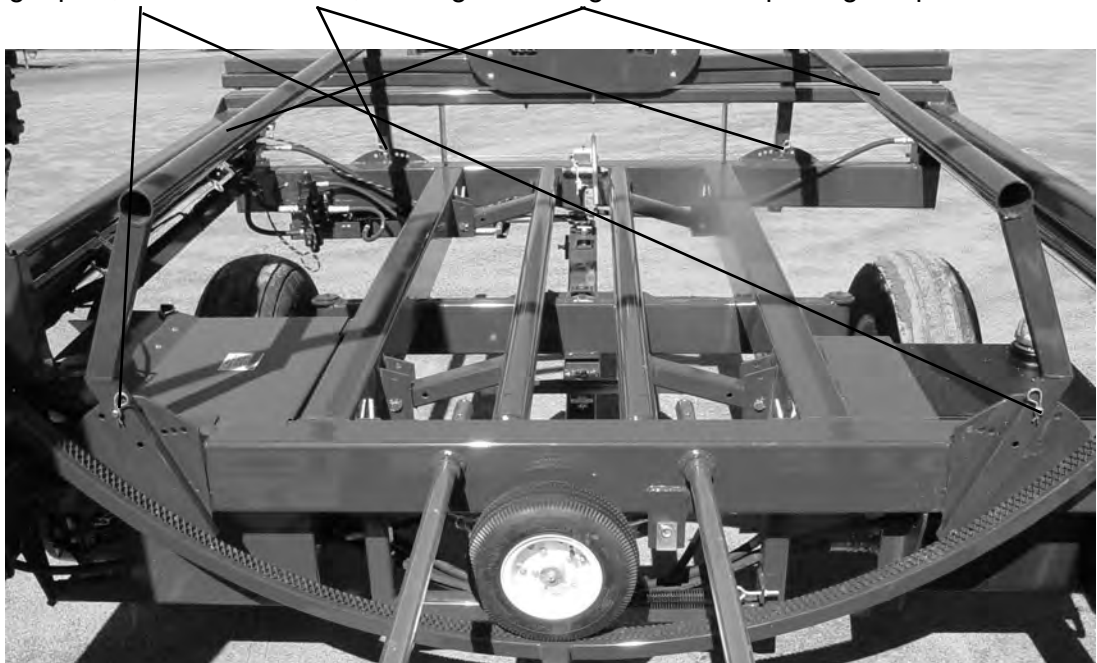

OPERATION

BALE RISERS - ROUND BALES

There are two risers at the front of the machine. All round bales must be wrapped with the riser in the down position. These risers serve as a loading platform for round bales in the down position.

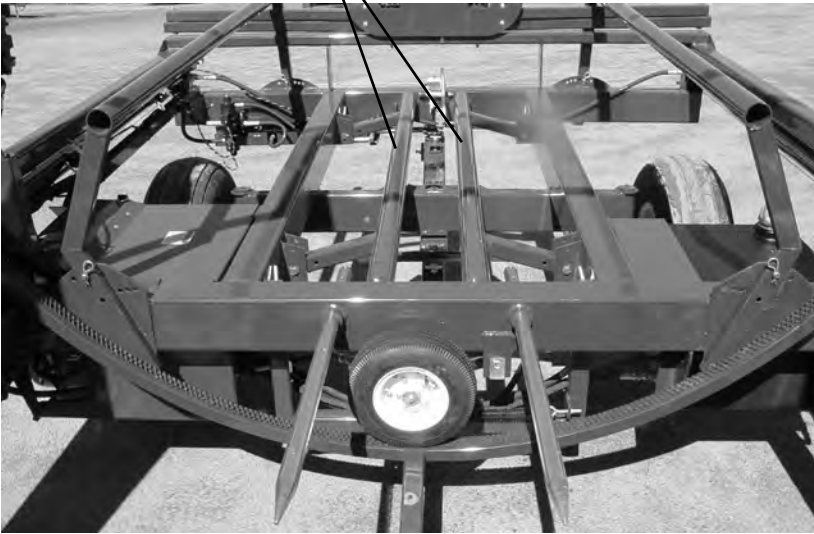

**Always shut engine
off before making
adjustments.**

BALE RISERS - SQUARE BALES

Placing the risers in the up position allows a square bale to be wrapped sideways. Be sure to remove the spikes from the low position and pin them into the end of the risers after raising them. The automatic start bar must be moved to the up position for square bales as shown below. Lift start bar and slide to your right and rest on the higher section of the bracket. Remove hair pin from end hole and place in second hole from the end of the rod. This will secure start bar in the up position. Start bar is now in position to be activated by square bale when placed on the riser in the up position. Bales can also be wrapped lengthwise with the installation of the optional Riser Shelf. When risers are lowered for round bales, start bar must again be lowered.



OPERATION

CONTROLS

There are four switches on the control panel. The mode selection switch allows the operator to wrap bales manually, automatically, or from the optional remote control. The Linewrap will not operate in the remote position unless the remote option is installed on the machine. The manual hoop switch allows the operator to rotate the hoop while in the manual mode. The manual pusher switch allows the pusher to be moved forward or reverse while in the manual mode. The start/reset switch is to be used after starting the engine or after the emergency stop has been activated.

IF THE EMERGENCY STOP IS TRIPPED DURING WRAPPING CYCLE, THE UNIT MUST BE SWITCHED TO MANUAL OPERATION ON THE CONTROL PANEL. PRESS THE START/RESET SWITCH, THEN PRESS AND HOLD THE MANUAL PUSHER AND HOOP SWITCHES TO BEGIN WRAPPING AGAIN. WHILE HOLDING SWITCHES, SELECT THE DESIRED MODE, AUTOMATIC OR REMOTE ON THE CONTROL BOX TO CONTINUE NORMAL OPERATION.



BALE ADJUSTMENT SWITCHES

Adjust the hoop start switch to the number 1 as shown. Adjust the hoop stop/pusher return switch the same amount of footage as the length of the bale (Markings are in 1' increments). Example; with a 4' bale the hoop stop/pusher return switch should be set at the number 5. Be sure wires from switches are placed in the storage channel below switches.

Always shut engine off before making adjustments.



OPERATION

WRAPPING

1. Start the engine, let it idle for a short period of time to warm up.
2. Release the tail/ramp hydraulic locking valve while keeping the manual lock bar connected.
3. Activate the hydraulic control lever to pressurize the tail/ramp system.
4. Disconnect the tail/ramp lock bar and rotate it forward to the storage position.

Note; Stand aside of the tail/ramp when disconnecting the lock bar in case there is an air pocket in the system that would allow the tail/ramp to fall back upon removal.

5. Turn the wheel brake valve to the upright or off position.
6. Activate the hydraulic control lever to lower the tail/ramp. The ramp will lower and the wheel brake will set.
7. Activate the Start/Reset switch on the control box by pushing up and releasing. This switch must always be activated before any functions of the control box will operate.
8. Place the Mode switch in the manual position.



Tail/Ramp Hydraulic Locking Valve

9. Place a bale on the table, engage the manual push forward switch and hold to push the bale into the wrapper - DO NOT ENGAGE THE HOOP TO WRAP THE BALE.
10. Continue this operation until there are 4 bales pushed through the LINEWRAP without being wrapped. This will create a pressure backstop to ensure that there are no air pockets between the wrapped bales.
11. Place an end cap on the 5th bale, load onto the wrapper, and manually engage the hoop switch to wrap the bale when it reaches the beginning of the hoop.

12. The amount of wrap can be adjusted by turning the hoop speed control valve. Silage bales should be wrapped with 9-10 layers of film. 1 wrap should be the equivalent to 1 mil of film. Check with your film vender for thickness. The number of layers of film can be determined by dividing the width of the film (in inches) by the number of inches between wraps. The number of inches between wraps is determined by measuring the seam to seam distance of the film on the bales.

Example: Film width = 30 inches, distance between wraps is 3 inches, the amount of film being applied is $30/3 = 10$ layers of film.



Hoop Speed Control

OPERATION

MANUAL MODE

If the manual mode is selected after the steps on the previous page, follow these steps to continue wrapping.

1. Place another bale on the machine, manually engage and hold the pusher switch until it tightens to the previous bale, then engage and hold the hoop switch to start wrapping.
2. Hold manual hoop wrapping switch and manual pusher forward switch until there is sufficient room to place another bale on the machine.
3. Release both switches at this time.
4. Engage and hold the pusher reverse switch until the pusher returns to its home position.
5. Repeat the above process to continue wrapping.

AUTOMATIC MODE

If automatic mode is selected after the steps on the previous page, follow these steps to continue wrapping.

1. Place the Mode selection mode to Automatic.
2. Place another bale on the machine.
3. The start bar will be depressed and the pusher will start to move and push bale. The hoop start switch will be activated by the pusher and the hoop will begin to rotate. When the pusher stop switch is activated by pusher, the pusher will stop and return to its home position allowing room for another bale to be placed on the machine and the process repeated.

REMOTE MODE

If the LINEWRAP is equipped with optional remote and the remote mode is selected after the steps on the previous page, follow these steps to continue wrapping.

1. Place the Mode selection mode to Remote.
2. Place another bale on the machine.
3. Press the start button on the remote handset.
4. The pusher will start to move and push bale. The hoop start switch will be activated by the pusher and the hoop will begin to rotate. When the pusher stop switch is activated by pusher, the pusher will stop and return to its home position, allowing room for another bale to be placed on the machine. Repeat the process.

NOTE: When there are enough wrapped bales on the ground to provide a stable row to push against, pick up the unwrapped bales that were pushed through the machine and not wrapped. Place these bales back on to the machine and continue wrapping.

OPERATION

WRAPPING - FINISHING

1. Continue to add bales until there are 3 bales remaining.
2. Flip the Mode Switch to the Manual Mode to manually wrap the last 3 bales. As the last bales are going through, apply more film to the seams between each of the bales.
3. Install an end cap on the last bale and continue to wrap the last bale manually until the pusher is to the end.
4. Return the pusher to its home position.
5. Shut engine off.

BALE PUSH-OFF

1. Remove the two pins and clips for the last bale push off, fold out mechanism to the locked position, and replace the pins and clips.
2. Start engine and push the Start/Reset switch on control panel.
4. Again manually start wrapping the last bale. When the last bale has been fully wrapped, release the manual hoop switch.
5. Shut engine off.
6. Cut off plastic film between bale and pre-stretcher.
7. Restart engine, push the Start/Reset switch on control panel and hold the manual pusher forward switch until the last bale is pushed as far as possible.
8. Return the pusher to its home position.
9. Shut engine off.
10. Remove the two pins and clips for the last bale push off, retract the mechanism to the storage position and replace the pins and clips.



WRAPPER PULL-OUT

1. Open the wheel brake lockout valve.
2. Extend the tongue out to the transport position making sure that the tongue is securely locked.
3. Hook the tongue to a tow vehicle and slowly pull the machine away from the bales.
4. Start the engine, raise the tail/ramp into the transport position, close the tail/ramp lockout valve and connect the tail/ramp lock bar for transport.
5. Shut the engine off. The machine is now ready for transport.
6. Inspect the row for any holes that may have been made. If holes are present, seal with duct tape.

SERVICE & ADJUSTMENTS

MAINTENANCE PRECAUTIONS

WHEN PERFORMING ANY INSPECTION OR MAINTENANCE WORK ON THE ELECTRONIC SYSTEM, ALWAYS TAKE SPECIAL CARE TO PREVENT INJURY TO YOURSELF AND OTHERS OR DAMAGE TO THE EQUIPMENT.

The following are general precautions which should be closely followed.

1. Do not have hydraulic power available to the valves when performing electrical tests.
2. Never operate or test any function with any other person near or on the machine.
3. Take care to prevent metal tools from coming in contact with sensitive electronic components.
4. Turn power off before connecting or disconnecting valve coils or other electrical loads.

ROUTINE MAINTENANCE

1. Clean transmitter regularly with a damp cloth and mild detergent.
2. Periodically check switch mounting nuts and compression fittings for tightness.
3. Inspect electrical wiring for wear points or other damage. Repair as required.
4. Inspect all connections (especially to the valves) for looseness or corrosion. Tighten and/or “seal” as necessary.

REMOTE CONTROL

Description

KAR-TECH’s control system is a micro-controller based system designed to provide the machine operator with the possibility to remotely operate equipment. The machine operator is still required to follow OSHA and other applicable standards when operating the equipment. The control system consists of two major modules; the controller unit, and the receiver with a hand held transmitter. The receiver is operated by connecting the unit to the controller and turning on the power switch. The hand held transmitter has two buttons that can control the system, and a red LED to indicate when the unit is transmitting. The buttons operate the Start and Stop functions of the controller.

Display

The system is designed with an integrated 4-Character Alphanumeric red LED Intelligent Display (located just center inside control box). This display serves two functions:

1. The display will show the number of bales the Linewrap has wrapped. The counter can not be reset.
2. The display will show diagnostic information for troubleshooting.

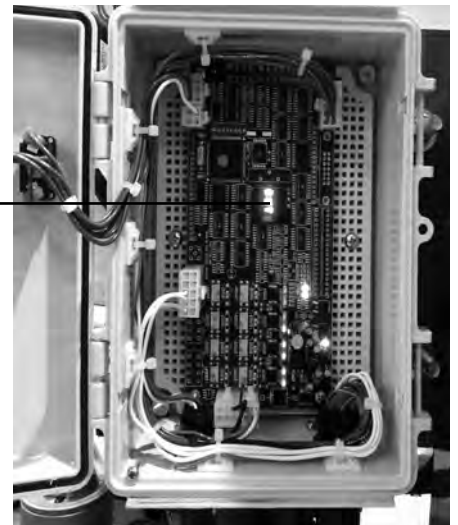

SERVICE & ADJUSTMENTS

TRANSMITTER

Lights:

There is a Green and a Red light both inside the receiver and on the remote.

- The Green LED on the remote and receiver blinks every 1/2 second if there is communication between the remote and the receiver. It will blink once a second if there is no communication (i.e.: no power to the receiver).
- The remote's Red LED also blinks every 1/2 second if the batteries are low. (recharge by plugging in the remote) When the remote is charging, the red LED will be solid. Once it is fully charged, the green LED will be solid.
- Each remote and receiver pair are synchronized at the factory. If a new remote or receiver is needed, synchronization is required.

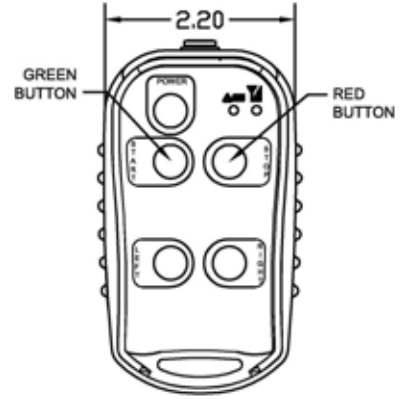

Synchronization Steps:

1. Turn both the remote and receiver off (use battery disconnect to turn the receiver on/off).
2. With the receiver off, press and hold the power button of the remote for 10 seconds, both LEDs on the remote will flash in unison.
3. Turn on the receiver.
4. Wait a few seconds until only the green led on the remote begins to flash rapidly.
5. Synchronization complete.

<u>Receiver</u>	<u>Probable cause</u>
<u>Error Codes</u>	
1	Communication problem
4	Faulty circuit right
5	Faulty circuit left
Error code is the number of red flashes between the pause.	

<u>Remote</u>	<u>Probable cause</u>
<u>Error Codes</u>	
1	Low Battery
4	Faulty circuit right
5	Faulty circuit left
Error code is the number of red flashes between the pause.	

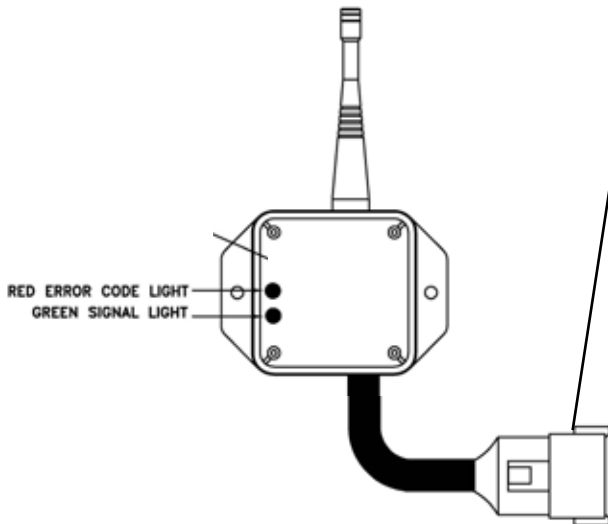

PLUG PIN# DESCRIPTION

- #1-Ground
- #2-No Connection
- #3-No Connection
- #4-No Connection
- #5-Stop Output (Button #1)
- #6-No Connection
- #7-No Connection
- #8-No Connection
- #9-Ster Right Output (Button #3)
- #10-Start Output (Button #2)
- #11-Ster Left Output (Button #4)
- #12-Power (9 to 35 VDC)

OPTIONAL EQUIPMENT

REMOTE CONTROL

The LINEWRAP has been designed to easily add a remote control option. The remote control allows the operator to start and stop the wrapping process - IT DOES NOT OPERATE THE START/STOP FUNCTION OF THE ENGINE. The remote option may be added by bolting the remote box next to the main control box and connecting the four pin remote connecting cord from the remote box to the main control box. With this remote option, the LINEWRAP may be started or stopped remotely from the tractor or skid-steer by use of the hand held activator. In order for the remote to operate, the mode switch on the control box must be put in the remote position. This will deactivate the start bar that would normally start the wrapping process in the automatic mode. By deactivating the start bar, the operator may set a bale on the machine without activating the wrapping process.



ELECTRIC-OVER-HYDRAULIC STEER CONTROL

The optional Electric-Over-Hydraulic Control can easily be installed to allow the operator to steer the LINEWRAP from the tractor or skid steer. To operate, simply push the right or left button on the hand held activator. The front indicator shows the operator where the tires are pointed. The Hydraulic Steering Control was designed to work while the machine is not wrapping. The Hydraulic Steering Control automatically includes the remote start/stop option. (See optional remote section).

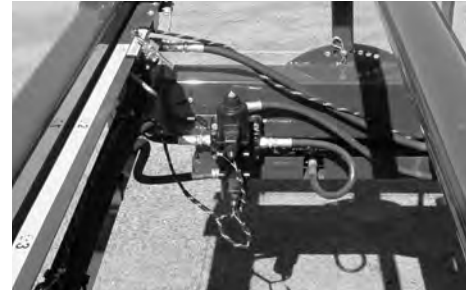

LIGHT KIT

Two LED lights and a switch are included in the optional kit for night wrapping.



SQUARE BALE RISER SHELF

An optional square bale riser shelf is needed for wrapping square bales in the lengthwise position.

LUBRICATION

Become familiar with all lubrication points and establish a routine to ensure complete lubrication of the LINEWRAP.

GENERAL INFORMATION

IMPORTANT: *Catch and dispose of fluid per local waste disposal regulations whenever service is performed on hydraulic components, valves, cylinders, hoses, etc.*

WHEEL BEARING LUBRICATION, CLEAN & REPACK INSTRUCTIONS

Grease wheel bearings as needed depending on amount of travel.

Annually disassemble and clean parts in a solvent. Pack bearings with a high grade grease. Reassemble, and tighten nut until a slight drag is felt when wheel is turned. Back nut off and insert cotter pin into first hole that you see as you back the nut off, bend cotter pin over and reinstall cap.

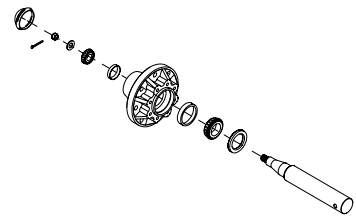

OIL RESERVOIR

Check the hydraulic oil level in the reservoir regularly. The level of the 20W hydraulic oil should be maintained above the half mark on the sight gauge located on the hydraulic oil reservoir. The filter in the hydraulic tank should be changed annually.



PUSHER SLIDES

To insure smoother operation and longer life of your LINEWRAP, apply liberal amounts of grease to the pusher slides daily, or when the slides appear dry. Additionally, lubricate the following with a light machine oil:

- * The removable fork mounts
- * The push-off arm pivots
- * The pivot points on the rear tailgate



LUBRICATION

GREASE FITTINGS

There are numerous grease fittings on the LINEWRAP. If lubricated properly and often enough, it will prolong the life of your machine. Grease daily during normal use and before and after storage and after power washing. Use a good grade of high quality grease. Make sure that grease comes out around the shaft on sleeve type bearings. Wipe off excessive grease to prevent accumulation of chaff or grit around the bearing. Replace any missing or plugged grease fittings.

Grease locations and recommended intervals are as follows:

Grease the Front Steering Mechanism as needed, at least annually.

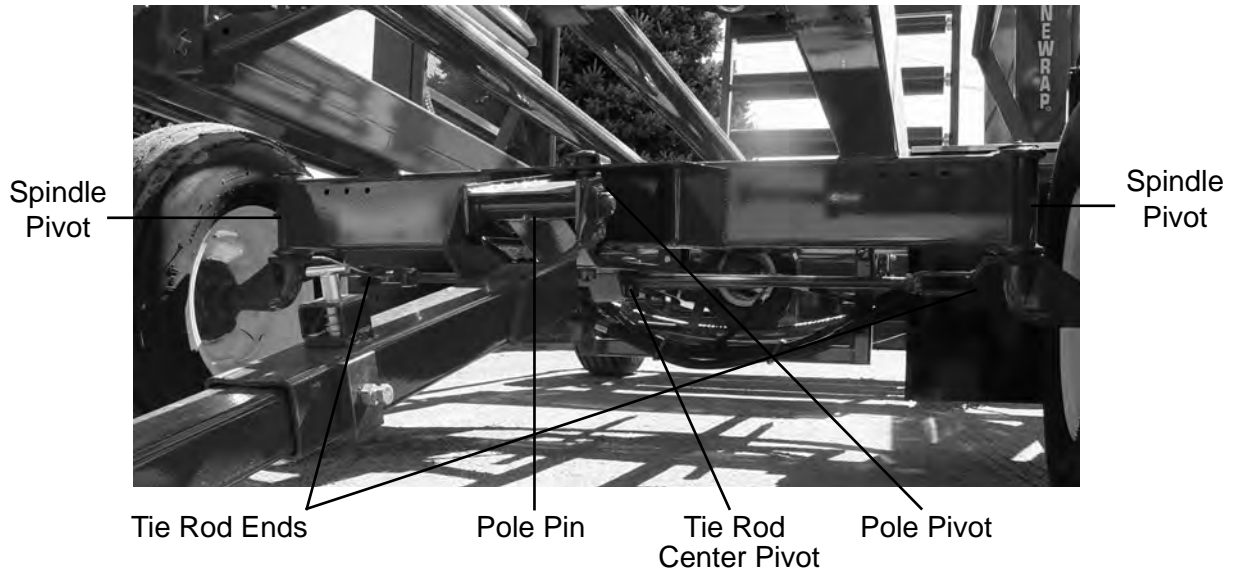

4 Zerks - Each Hoop Roller Support
Every 20 Hours of Operation

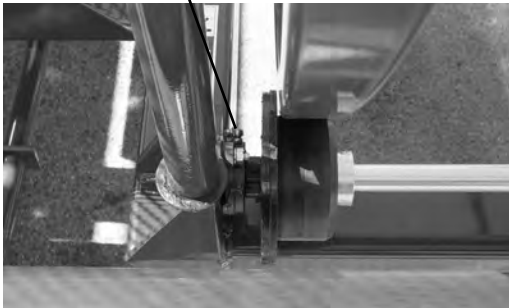

2 Zerks - 1 on each Tensioner
Annually Only



DECAL LOCATION

Your H&S LINEWRAP was manufactured with operator safety in mind. Located on the wrapper are various decals to aid in operation, and warn of danger or caution areas. Pay close attention to all decals on your LINEWRAP.



DO NOT REMOVE ANY OF THESE DECALS. IF DECALS ARE LOST, DAMAGED, OR IF LINEWRAP IS REPAINTED, REPLACE DECALS. REMEMBER: DECALS ARE FOR YOUR PROTECTION AND INFORMATION.

Listed below are the decals on your LINEWRAP. These decals may be ordered individually by part number or by ordering a complete set.

<u>PART #</u>	<u>QTY</u>	<u>DESCRIPTION</u>
311	1	Patent Number
5896C	2	Warning - Emergency Stop Function
8491	1	Front Decal
77423	1	RH Side Decal
77421	1	LH Side Decal
11599	2	Warning - Stay Clear of Leaks
12797B	1	Pusher Stop
21797A	1	Electric Switches Decal
31500	1	Charge Battery Before Use
32597A	1	Warning - Do Not Operate
32597B	3	Danger - Stay Clear
32597C	5	Danger - Shut Engine Off
32597D	2	Warning - Do Not Operate
32597E	2	Warning - Do Not Remove Shields
41097A	1	If Llinewrap is setting... Disconnect Ground Terminal
54033	1	Made in U.S.A. 3"
55907	1	ATTENTION: Turn the fuel valve on the engine to the off position.
58654	1	Measurement to adjust hoop start/stop switches for bale length
72203A	1	Warning Help Avoid Injury
81910	2	Film Wrap Diagram
1202177	4	Pull To Stop
DCAMB	2	Amber Reflector
DCRED	2	Red Reflector
LW112901	1	Optional Remote Steering Indicator
093020	13	Grease Zerk

DECAL LOCATION



DECAL LOCATION



093020

32597C

093020

32597D

81910



5896C

093020

32597D

32597C



32597B

093020

32597C

DCRED



32597B

DECAL LOCATION

In OP Manual Tube:
41097A, 31500

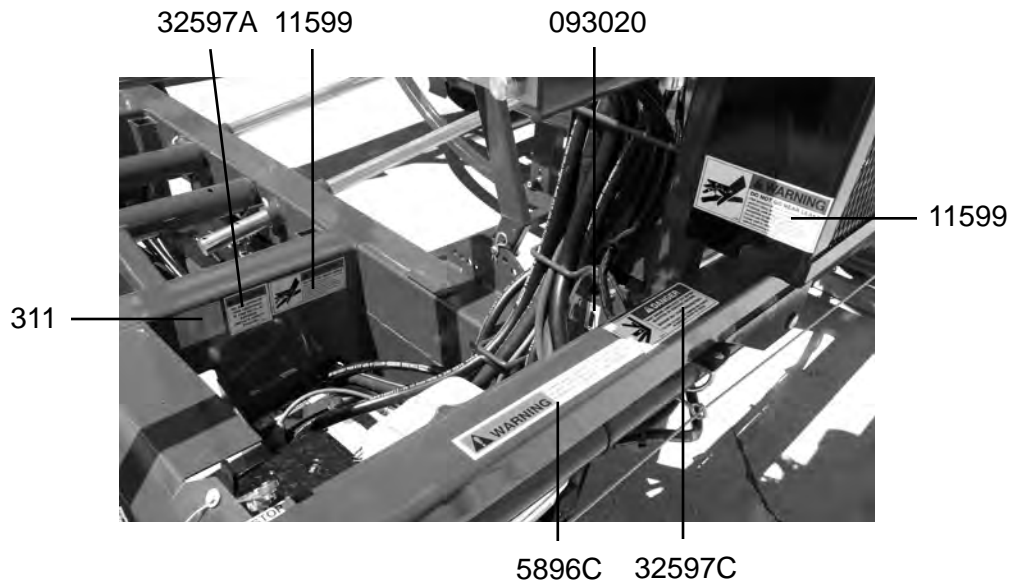
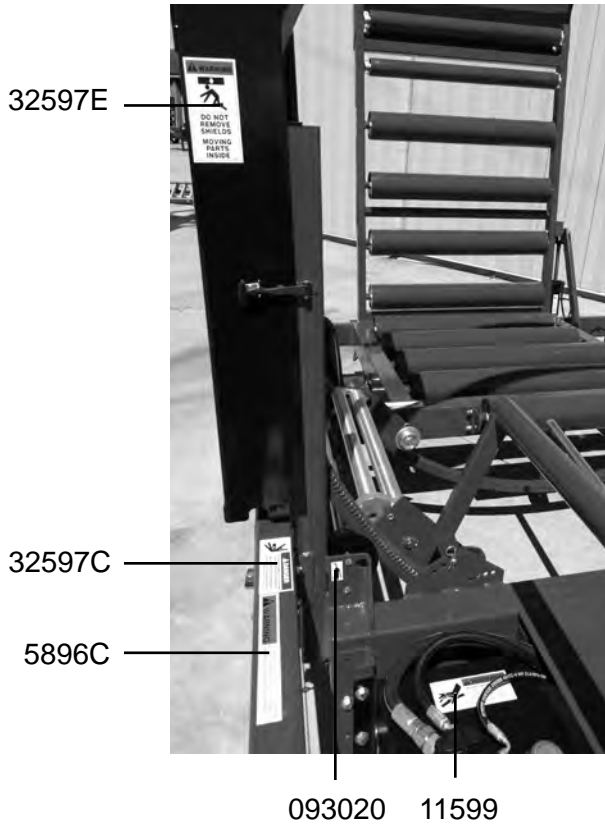

DECAL LOCATION

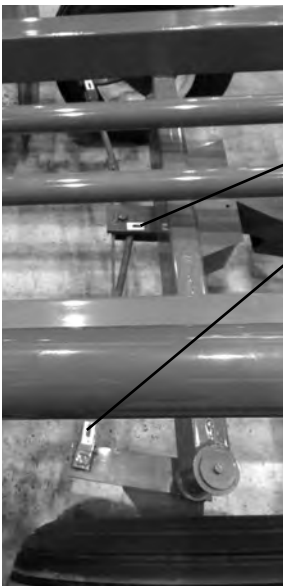

093020

12797B

1297A

58654

54033

32597C



DCAMB

1202177

8491

LW112901

1202177

DCAMB

TROUBLESHOOTING

TENSIONERS

If wrinkles appear in plastic while wrapping. . .

1. Check to make sure the wrap is threaded properly.

If plastic tears between tensioner and bale. . .

1. Make sure film holders are free. Turn holders by hand until free.
2. Use a higher quality plastic. Some brands are more tear resistant than others.
3. If the film on the roll is damaged, unroll the film until the damaged area has been removed.
4. Tensioners may be tacky. If tensioners are built up with adhesive from wrapping in hot weather, clean with mineral spirits.

ENGINE DOESN'T START

1. Engine out of gas.
2. Gas shut-off is closed
3. Not getting gas, set choke to full

For other starting problems, refer to engine manufacturer's owner's manual.

MACHINE DOESN'T WRAP IN REMOTE, MANUAL, OR AUTOMATIC MODES

1. Press the start/reset button.
2. Insure wiring harness is properly connected to control box.
3. Insure wiring harness is properly connected to the engine.

MACHINE DOESN'T WRAP IN THE AUTOMATIC MODE

1. Press the start/reset button.
2. Make sure pusher is in the home position. The machine will not begin a wrapping cycle unless the pusher is in the home position (i.e., the limit switch that stops the pusher at the end of the cycle must be activated). If not in the home position, put machine in manual mode and manually return the pusher to the home position.

MACHINE DOESN'T WRAP IN THE MANUAL MODE

1. Press the start/reset button.
2. Make sure mode selection switch is in manual mode.

TROUBLESHOOTING

ELECTRONICS

Control Box

If there is no power at the control box:

1. Make sure that the battery disconnect switch is on.
2. Check 30 amp micro fuse located in engine start box.
3. Check wiring connections from engine start box to main control box.

On/Off Outputs

There are 3 On/Off outputs with 5 ampere capacity and short circuit, overload protection. Each on/off is designed with a built in short circuit or no load status circuits. The output status is reported to the machine operator via display. Refer to the STATUS DISPLAY ERROR CODE CHART of this manual.

On/Off Inputs

The system is designed with 7 digital (switched to 12 VDC) inputs. There are two inputs received from the remote control unit, and the other inputs from limit switches on the machine.

Display

The system is designed with an integrated 4-Character Alphanumeric red LED Intelligent Display. This display is used to report the status of the bale count and outputs to the machine operator. If there are active error codes, they will be displayed. For additional information on error codes refer to the STATUS DISPLAY ERROR CODE CHART of this manual. If there is no active error, the bale count will be displayed.

Below is an example of how to read the counter in the control box.

1. Open the control panel door by removing the 2 screws.
2. Turn the engine key to the on position.
3. Locate the LED screen; it will be flashing RST (Reset).
4. Push and release the reset switch on the control panel.
5. The LED screen will now be flashing one of the following.

For a bale count up to 9,999 bales, the LED screen will display and alternate between the following;

For 7,345 bales:

Screen 1: CNT

Screen 2: 7345 – or the number of bales up to 9999

For a bale count higher than 9,999 bales, the LED screen will display and alternate between the following;

For 12,345 bales:

Screen 1: CNT

Screen 2: 0001

Screen 3: 2345 – or the number of bales up to 19,999

Every 10,000 bales, Screen 2 will change numbers, 0002, 0003, 0004, etc.

TROUBLESHOOTING

This section provides basic operator level troubleshooting for the system. If, after following these instructions, the system still does not function, check the hydraulic system then contact your H&S Dealer for further instructions or servicing.

STATUS DISPLAY ERROR CODE CHART

<u>Display shows</u>	<u>Problem/Solution</u>
RST	Press Start/Reset Button
EC01	Short or open connection at output to forward solenoid
EC02	Short or open connection at output to reverse solenoid
EC03	Short or open connection at output to hoop solenoid

PROBLEM SOLUTION CHART

<p>No operation of all functions when a function switch is activated.</p>	<ul style="list-style-type: none"> > Check that power switch is on. > Check vehicle wiring for power into the system. > Check display for system status. > Check for proper grounding of vehicle's electrical circuit. > Check vehicle's hydraulic system
<p>Certain functions do not work</p>	<ul style="list-style-type: none"> > Check the wiring connection from the system to the valve coil or the output function that do not work. > Check function's coil. > Check display for system status. > Check vehicle's hydraulic system > Check vehicle's electrical system
<p>Function operates intermittently.</p>	<ul style="list-style-type: none"> > Loose connection at the function switch. > Loose connector at the valve coil. > Check display for system status.

There are no user-serviceable parts for the controller.

Return the units to Kar-tech for service.



H&S MFG. CO.

products approved

for the

FEMA

SEAL OF QUALITY



Manufactured by:

H&S MANUFACTURING CO., INC.

2608 S. HUME AVE. MARSHFIELD, WI 54449

(715) 387-3414 | hsmfgco.com

