



M9

PARTS BOOK



Revision #03
Starting Serial #716313

HSMFG0714

Part #60103

Manufactured By
H&S MANUFACTURING CO., INC.

P.O. BOX 768 (715) 387-3414 FAX (715) 384-5463
MARSHFIELD, WISCONSIN 54449

CONTENTS

Instructions for Ordering Parts - About Improvements	1
Figure 1 - Main Frame and Pole.	2-3
Figure 2 - Conveyor Belt and Rollers.	4-5
Figure 3 - Pick - Up Head (Front).	6-7
Figure 4 - Pick - Up Head (Rear).	8-9
Figure 5 - Hydraulics.	10-11
Figure 6 - Hydraulic Cylinder(2 x 8).	12
Figure 7 - Wiring and Lights(Serial #316249 and Prior).	13
Figure 8 - Wiring and Lights(Serial #316250 and Prior).	14
Figure 9 - Optional Windrow Inverter.	15
Figure 10 - Optional Accelerator.	16-17
Figure 11 - 2' Extension.	18-19
Figure 12 - Optional Wet Kit.	20-21
Parts Notes.	22

INSTRUCTIONS FOR ORDERING PARTS

All service parts should be ordered through your authorized H&S dealer. They will be able to give you faster service if you will provide them with the following

1. Model & Serial number is located on the right side frame behind the transport wheel.
2. All reference to left or right apply to the machine as viewed from the rear.
3. Parts should not be ordered from illustration only. Please order by complete part number.
4. If your dealer has to order parts - give shipping instructions:

VIA truck - large pieces (please specify local truck lines)

VIA United Parcel Service (include full address)

H&S MFG. CO. INC.	
MARSHFIELD, WIS.	
MOD. NO.	<input type="text"/>
SER. NO.	<input type="text"/>
DESCR.	<input type="text"/>

PLEASE RECORD NUMBERS FOR YOUR UNIT FOR QUICK REFERENCE

ABOUT IMPROVEMENTS

H&S IS CONTINUALLY STRIVING TO IMPROVE IT'S PRODUCTS

We must therefore, reserve the right to make improvements or changes whenever it becomes practical to do so without incurring any obligation to make changes or additions to the equipment previously sold.

FIGURE 1

MAIN FRAME/POLE

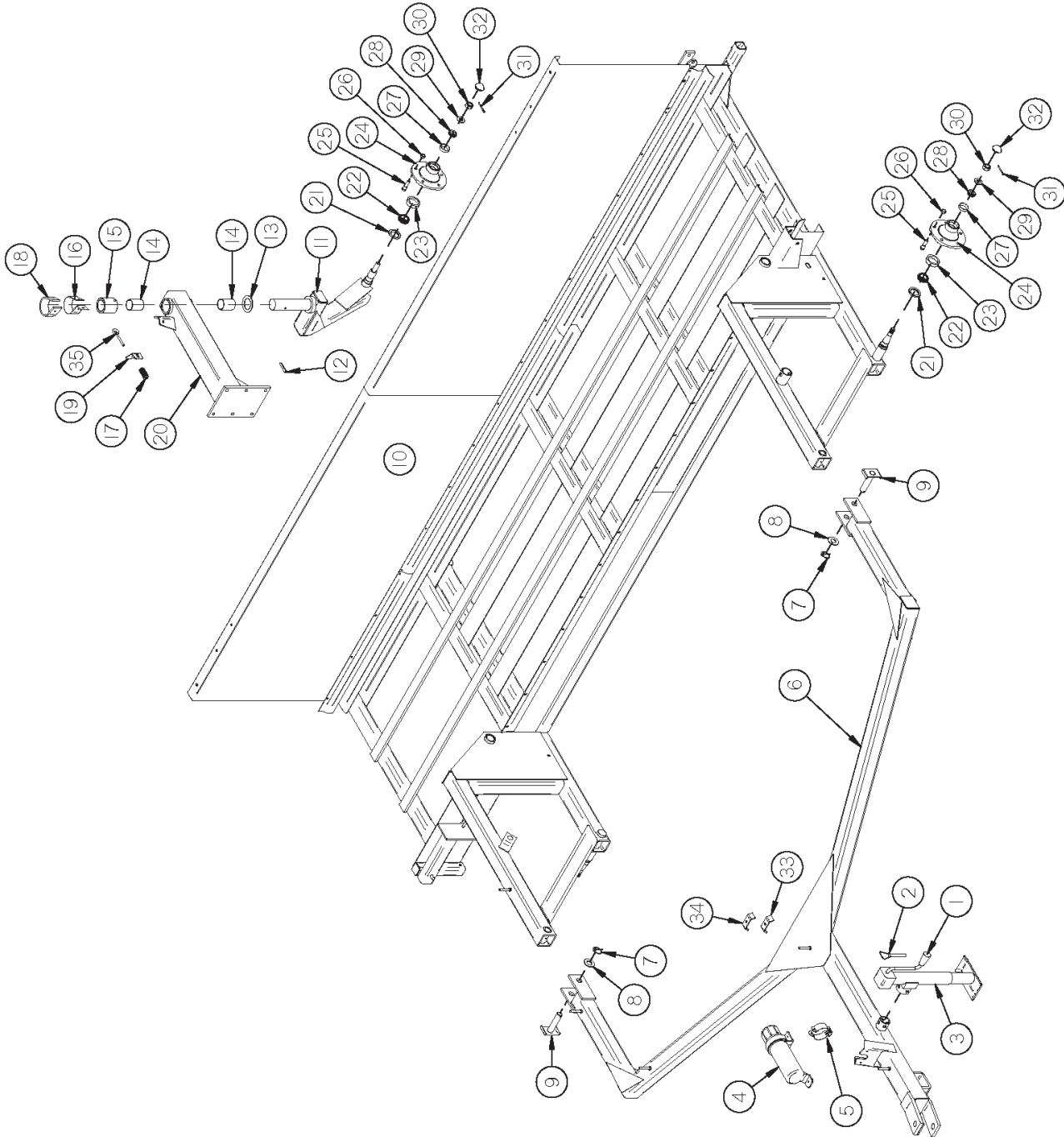

FIGURE 1

MAIN FRAME/POLE

<u>ITEM</u>	<u>PART #</u>	<u>DESCRIPTION</u>
1	B17B	JACK HANDLE
2	BFR4	JACK PIN & CHAIN
3	BFR753A	JACK
4	S522	MANUAL HOLDER
5	S523	MANUAL CLAMP LARGE
6	SWM65	POLE
7	YPLY08011	LYNCH PIN, 1/4" X 1-9/16" #63-02
8	SWM36	WASHER-PIVOT
9	SWM14	PIVOT PIN
10	SWM66	MAIN FRAME
11	SWM2	CASTER
12	YPEX10025	EXPANSION PIN, 5/16" X 2-3/4"
13	RG24	BRONZE WASHER 2" ID X 3" OD X 1/8"
14	RG26	BUSHING, BRONZE, 2.015" ID X 2.25" OD X 2.00" LONG
15	DWM59	BRAKE BUSHING
16	WM286	BRAKE BAND
17	WM210	SPRING-RED
18	WM288	BRAKE PAD
19	WM211	BRAKE ANGLE
20	SWM3	CASTER MOUNT
21	BFR57	SEAL
22	BFR58	INNER BEARING
23	BFR59	INNER RACE
24	BFR60	HUB, WITH RACES AND STUDS
*	BFR75	HUB (COMPLETE)
*	BFR67	WHEEL 5 X 15 (3)
*	BFR128	TIRE 6.70 X 15 SL (3)
25	YBSD16005	STUD BOLT
26	YNWL16005	NUT
27	BFR61	OUTER RACE
28	BFR62	OUTER BEARING
29	YWFL24010	WASHER
30	YNSL24010	NUT
31	YPCT05010	COTTER PIN
32	BFR66	HUB CAP
33	HE42	HOSE HOLDER (6)
34	23N67	HOSE HOLDER (5)
35	YBTE10040	I-BOLT

NOTE: * MEANS NOT SHOWN

FIGURE 2

CONVEYOR BELT/ROLLERS

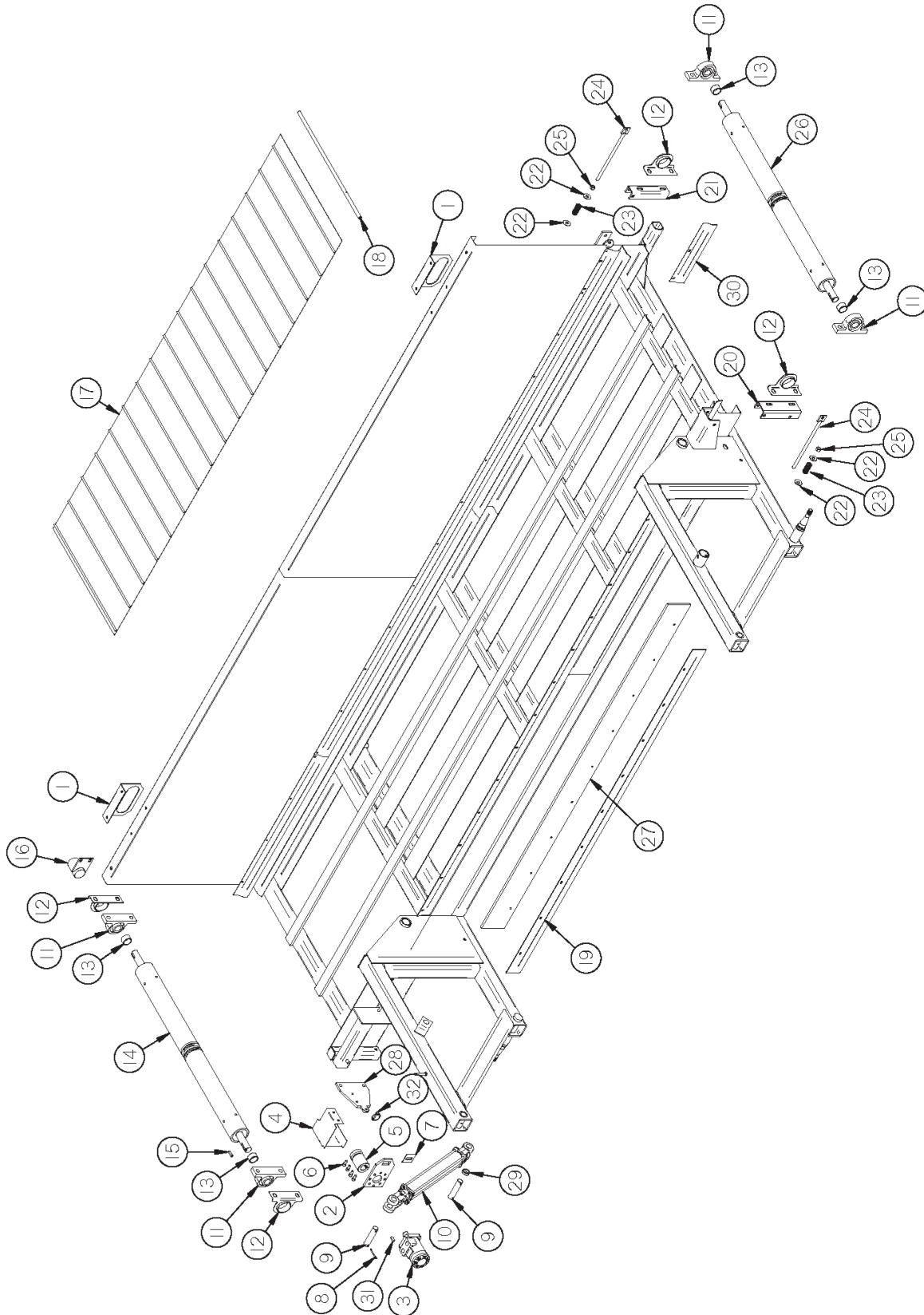

FIGURE 2

CONVEYOR BELT/ROLLERS

<u>ITEM</u>	<u>PART #</u>	<u>DESCRIPTION</u>
1	SWM28	LIGHT BRACKET
2	DWM39	TORQUE ARM
3	DF1	HYDRAULIC MOTOR
*	WM225	SEAL KIT
4	DWM42	RIGHT MOTOR SHIELD
5	DWM27	COUPLER
6	YSHS08045	CAP SCREW-COUPLER
7	DWM45	MOTOR SPACER
8	YPCT06020	COTTER PINS 7/32" X 2"
9	23N107	CYLINDER PIN
10	55999	2" x 8" HYDRAULIC CYLINDER
11	DWM132	PILLOW BLOCK BEARING
12	DWM36	ANTI-WRAP GUARD
13	SWM30	HEAD SPACER
14	SWM11	DRIVE ROLLER
15	G23B	KEY 5/16" X 1-3/8"
16	DWM31	SHAFT SHIELD
17	WM237	CONVEYOR BELT
*	WM379	DUTCHMEN BELT 42" X 3-1/4" SINGLE
18	SWM37	LACING PIN
*	SWM38	CROSS CONVEYOR LACING
19	WM236	SKIRT
20	SWM34	TIGHTENER ARM
21	SWM33	BACK TIGHTENER ARM
22	YWFL16005	WASHER 1/2"
23	DWM125	SPRING-BLUE
24	DWM25	TIGHTENER
25	YNHX16005	NUT 1/2"
26	SWM10	CONVEYOR ROLLER
27	WM235	SKIRT BELT
28	DWM51	MALE TORQUE ARM
29	K132	SPACER
30	SWM59	SKIRT EXTENSION
31	5B10	KEY 1/4" X 1" WOODRUFF
32	YPLY08011	LYNCH PIN, 1/4" X 1-9/16" #63-02

NOTE: * MEANS NOT SHOWN

FIGURE 3
PICK - UP HEAD (FRONT)

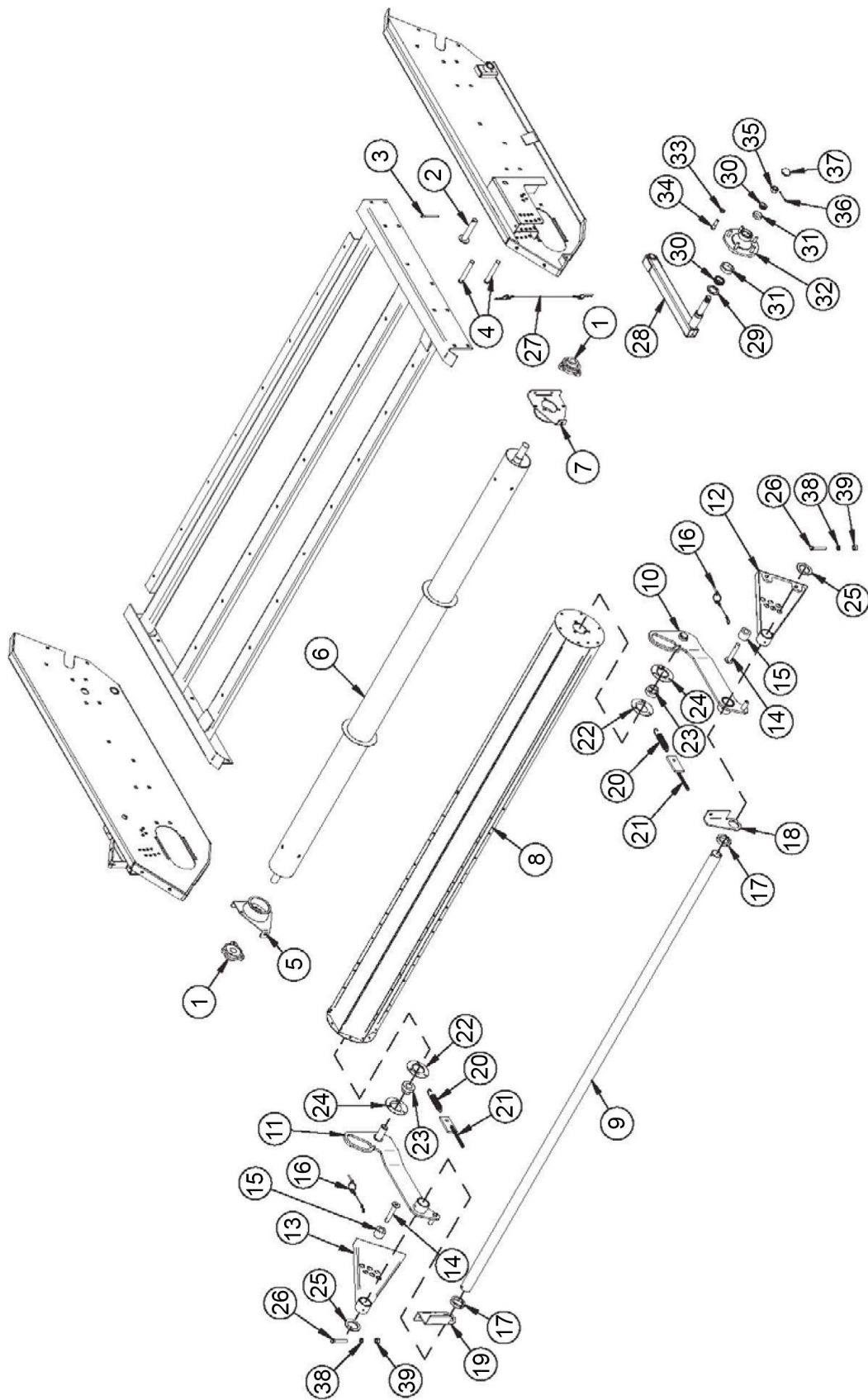

FIGURE 3

PICK - UP HEAD (FRONT)

<u>ITEM</u>	<u>PART #</u>	<u>DESCRIPTION</u>
1	55660	3 BOLT PILLOW BLOCK BEARING W/COLLAR
2	DWM7	PIVOT PIN
3	YPCT06020	COTTER PIN 3/16" X 2"
4	YPCV16020	CLEVIS PIN
5	WM179	RIGHT FRONT ROLLER BRACKET
6	WM342	FRONT ROLLER
7	WM192	LEFT FRONT ROLLER BRACKET
8	WM356	9' CROP ROLLER
9	WM357	FRONT SUPPORT
10	WM348	LEFT ARM
11	WM349	RIGHT ARM
12	WM351	LEFT BRACKET
13	WM350	RIGHT BRACKET
14	WM354	ADJUSTMENT PIN
15	WM353	POLY BUMPER
16	WM377	CROP ROLLER LANYARD
17	WM347	COLLAR
*	YSKP10010	SET SCREW, SOCKET, 5/16"-18 X 3/8"
18	WM363	SPRING TIGHTENER BRACKET LEFT
19	WM362	SPRING TIGHTENER BRACKET RIGHT
20	ST36	SPRING
21	12V78	TIGHTENER BRACKET
22	F14	FLANGE
23	12N122	1-1/4" BEARING WITH LOCK COLLAR
24	F114A	FLANGE (45° ZERK)
25	DWM227	WIND GUARD WASHER
26	YBHH10085	HEX BOLT, 5/16" X 2-1/4" GR.5
27	HD225	HITCH LANYARD
28	DWM229	GAUGE ARMS
29	CAT135A	SEAL
30	CAT10	BEARING (2)
31	BFR275	RACE (2)
32	CAT177	HUB-COMPLETE
33	YNWL16005	LUG NUT
34	YBSD16005	STUD
35	YNSL32005	SPINDLE NUT
36	YPCT05010	COTTER PIN
37	CAT46	HUB CAP
38	YWLO10005	WASHER, LOCK 5/16"
39	YNTL10005	HEX NUT, TOP LOCK, 5/16" - 18
*	SWM17	WHEEL (2)
*	SWM18	TIRE 5.70-8 (2)

NOTE: * MEANS NOT SHOWN

FIGURE 4
PICK - UP HEAD (REAR)

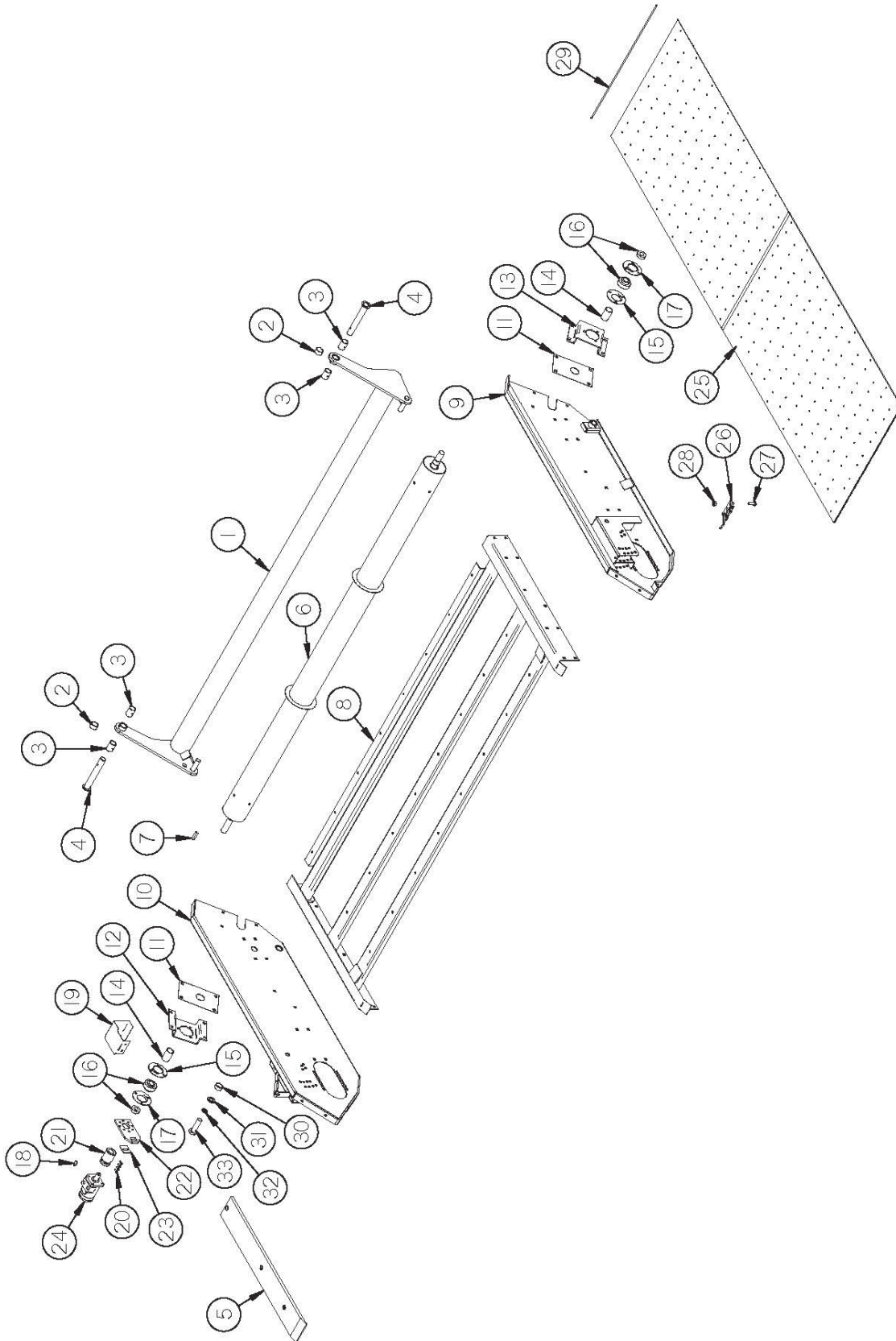

FIGURE 4

PICK - UP HEAD (REAR)

<u>ITEM</u>	<u>PART #</u>	<u>DESCRIPTION</u>
1	WM230	PICKUP LIFTER
2	SWM30	SPACER
3	RG132	BUSHING 1-1/4"ID X 2" LONG
4	SWM13	PIN
5	SWM15	PLASTIC SLIDES - (8) 9'
6	WM341	BACK ROLLER
7	G23B	KEY 5/16" X 1-3/8"
8	WM234	PICKUP BELT FRAME
9	DWM3	LEFT PANEL
10	DWM4	RIGHT PANEL
11	WM180	SIDE PANEL SLOT PLATE
12	WM187	BEARING BRACKET RH
13	WM186	BEARING BRACKET LH
14	WM343	PVC SPACER
15	F145	HEAVY DUTY FLANGE
16	55659	BEARING WITH LOCK COLLAR
17	F143	FLANGE W/ 45° ZERK
18	5B10	KEY 1/4" X 1" WOODRUFF
19	DWM43	HEAD SHIELD
20	YSHS08045	CAP SCREW-COUPLER
21	DWM27	COUPLER
22	DWM39	HYDRAULIC MOTOR MOUNT
23	DWM45	MOTOR SPACER
24	DWM84	HYDRAULIC MOTOR
*	WM225	SEAL KIT
25	SWM56	PICKUP BELTS ONLY - (3) 9'
*	SWM57	PICKUP BELT COMPLETE W/TEETH
*	SWM61	REPAIR DUTCHMAN KIT
*	SWM63	REPAIR DUTCHMAN KIT 2003 & NEWER
26	SWM1	PICKUP TEETH (260)
27	YBEV08005	1/4" X 3/4" ELEVATOR BOLTS
28	YNLK08005	1/4" KEPS LOCK NUTS
29	SWM41	LACING PIN
*	SWM39	ALLIGATOR LACE
30	WM183	PIVOT BUSHING
31	WM218	WASHER
32	YWLO32005	1" LOCK WASHER
33	YBHH32005	BOLT 1" X 2-1/2" GR.5 FULL THD.

NOTE: * MEANS NOT SHOWN

FIGURE 5

HYDRAULICS

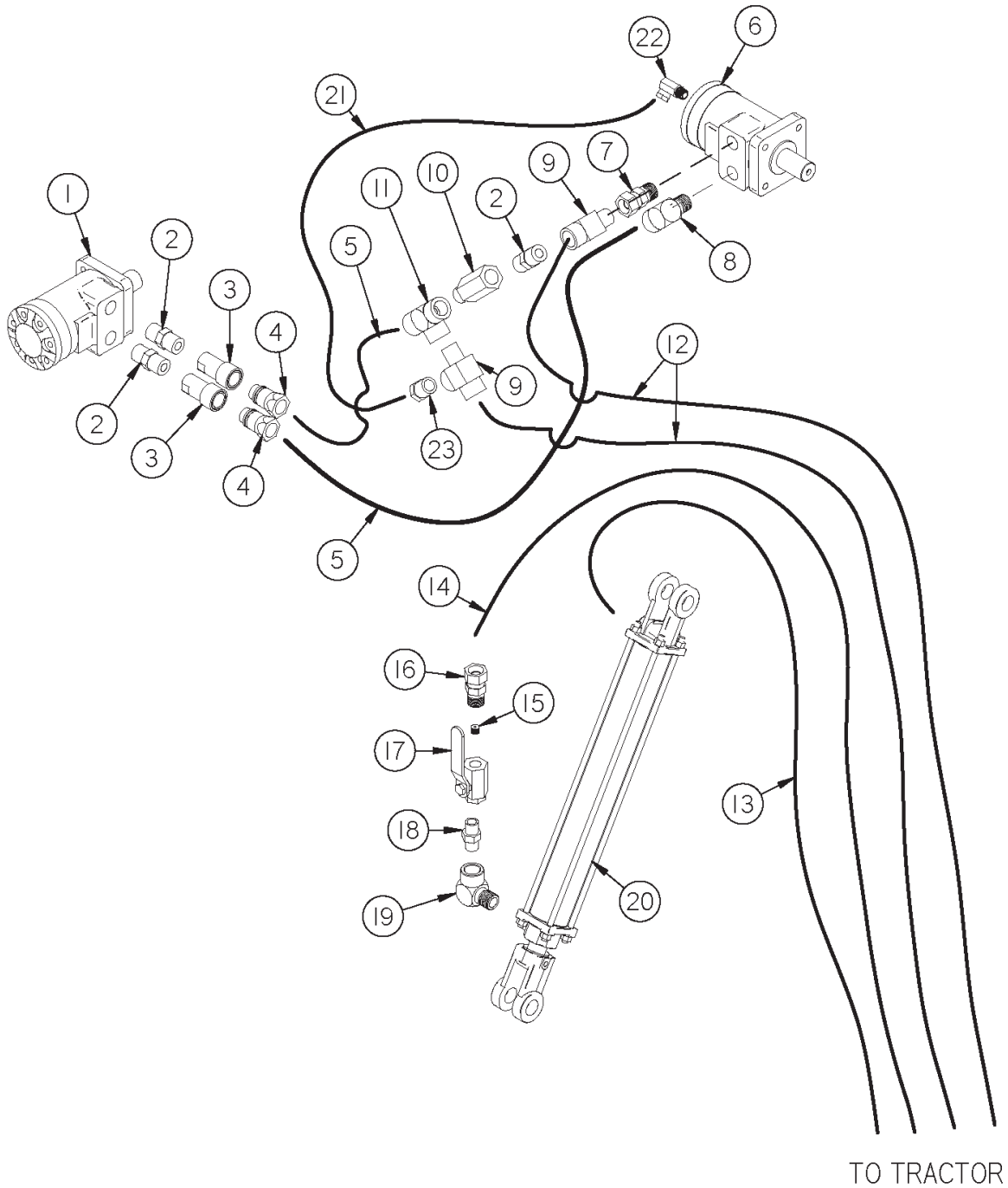

FIGURE 5

HYDRAULICS

<u>ITEM</u>	<u>PART #</u>	<u>DESCRIPTION</u>
1	DF1	HYDRAULIC MOTOR-CROSS CONVEYOR
*	WM225	SEAL KIT
2	WM141	1/2" NIPPLE NUT
3	DWM206	FEMALE COUPLER
4	DWM205	MALE COUPLER
5	SWM23	HOSE 1/2" X 42"
6	DWM84	HYDRAULIC MOTOR - PICKUP
*	WM225	SEAL KIT
7	LW174	1/2" MALE ADAPTER UNION
8	HE58	1/2" STREET ELBOW
9	LW96	1/2" STREET TEE
10	DF18	1/2" CHECK VALVE
11	DF8	1/2" TEE
12	SWM67	HOSE 1/2" X 240"
13	SWM68	HOSE 1/4" X 226"
14	SWM69	HOSE 1/4" X 214"
15	DWM250	ORIFICE .042
16	BFR122	3/8" MALE ADAPTER UNION
*	58722	ADAPTER UNION & ORIFICE
17	16SV338	3/8" BALL VALVE
18	16SV351	3/8" NIPPLE NUT
19	23N234	3/8" STREET ELBOW
20	55999	2" X 8" CYLINDER
21	BFR315	HYDRAULIC HOSE 1/4" X 20" 3/8" MP & 3/8" MPX
22	DWM119	ADAPTER O-RING TO 3/8" PIPE, 90 DEGREE
23	JB82	BUSHING, 1/2" TO 3/8" #5406-8-6

NOTE: * MEANS NOT SHOWN

FIGURE 6

HYDRAULIC CYLINDER (2 X 8)

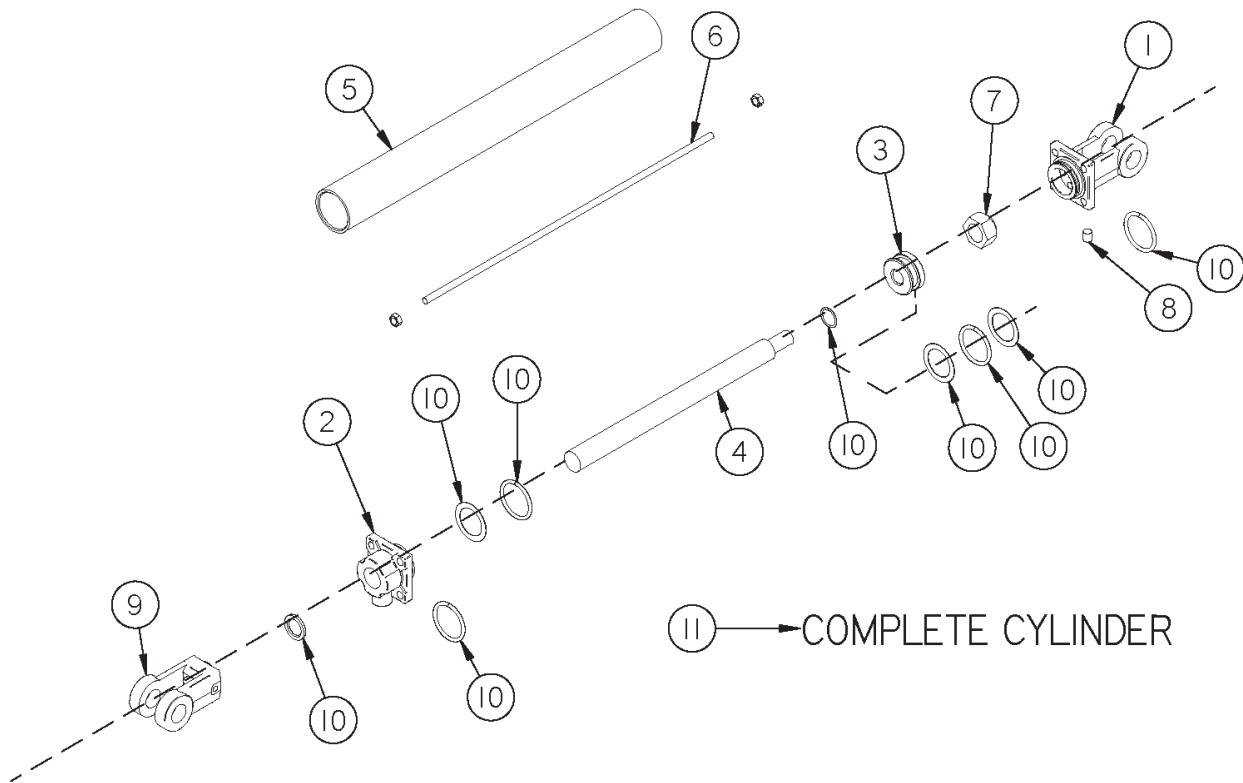

<u>ITEM</u>	<u>PART #</u>	<u>DESCRIPTION</u>
1	23N142A	CLEVIS CAP
2	56174	ROD CAP FOR 2" CYLINDER
3	56180	PISTON
4	T184A	ROD
5	BFR68	CYLINDER TUBE
6	T186	TIE ROD
7	23N148	PISTON NUT
8	23N149	PLUG
9	23N150A	ROD CLEVIS
10	56187	SEAL KIT
11	55999	2" X 8" COMPLETE HYDRAULIC CYLINDER

FIGURE 7
WIRING/LIGHT (Serial #316249 and Prior)

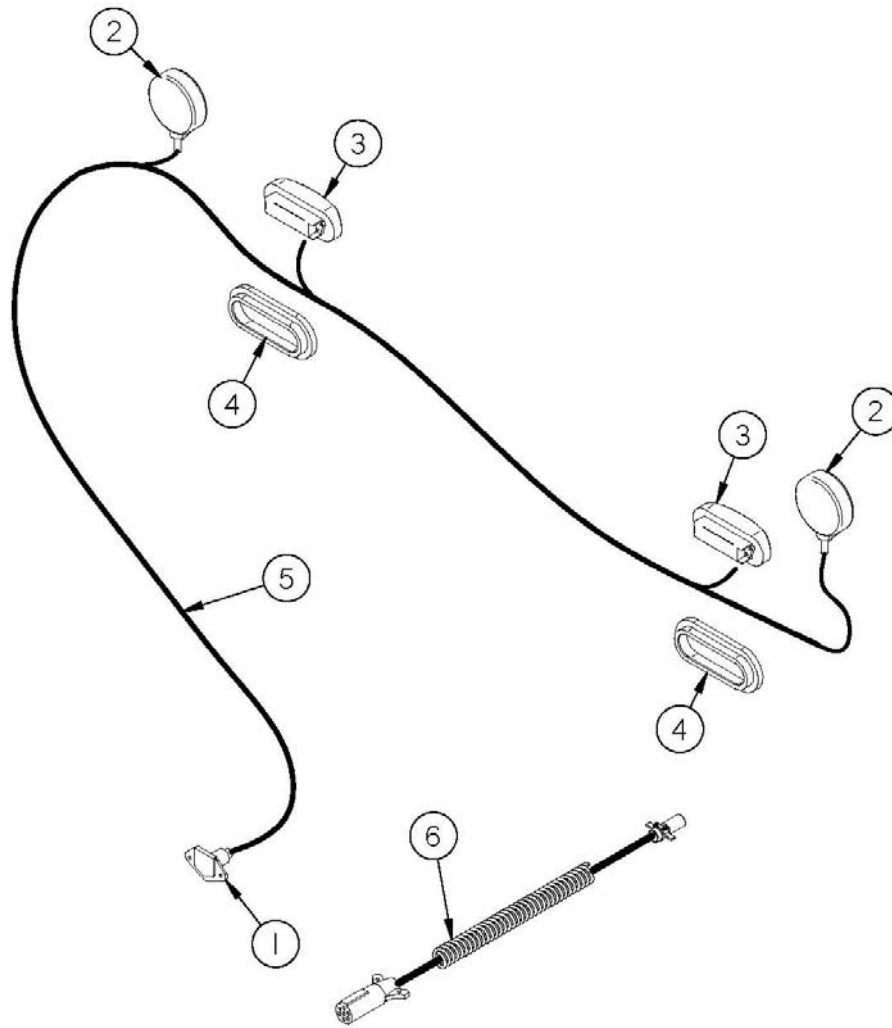

<u>ITEM</u>	<u>PART #</u>	<u>DESCRIPTION</u>
1	SWM46	PLUG IN
2	DWM129	YELLOW HAZARD LIGHTS
3	S310	RED TAIL LIGHTS
4	S308	RUBBER LIGHT MOUNT
5	SWM70	MAIN WIRE
6	TLPC	OPTIONAL TRACTOR CORD

FIGURE 8
WIRING/LIGHT (Starting Serial #316250)

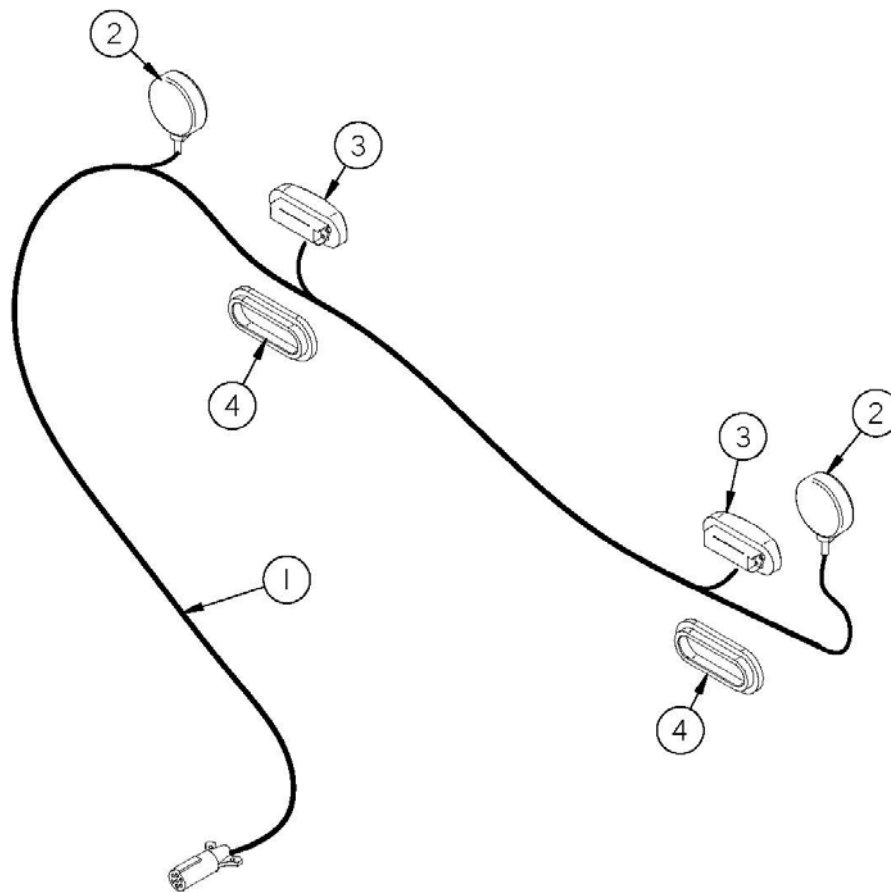

ITEM	PART #	DESCRIPTION
1	56087	WIRE HARNESS
2	DWM129	YELLOW HAZARD LIGHTS
3	S310	RED TAIL LIGHTS
4	S308	RUBBER LIGHT MOUNT

FIGURE 9
OPTIONAL WINDROW INVERTER

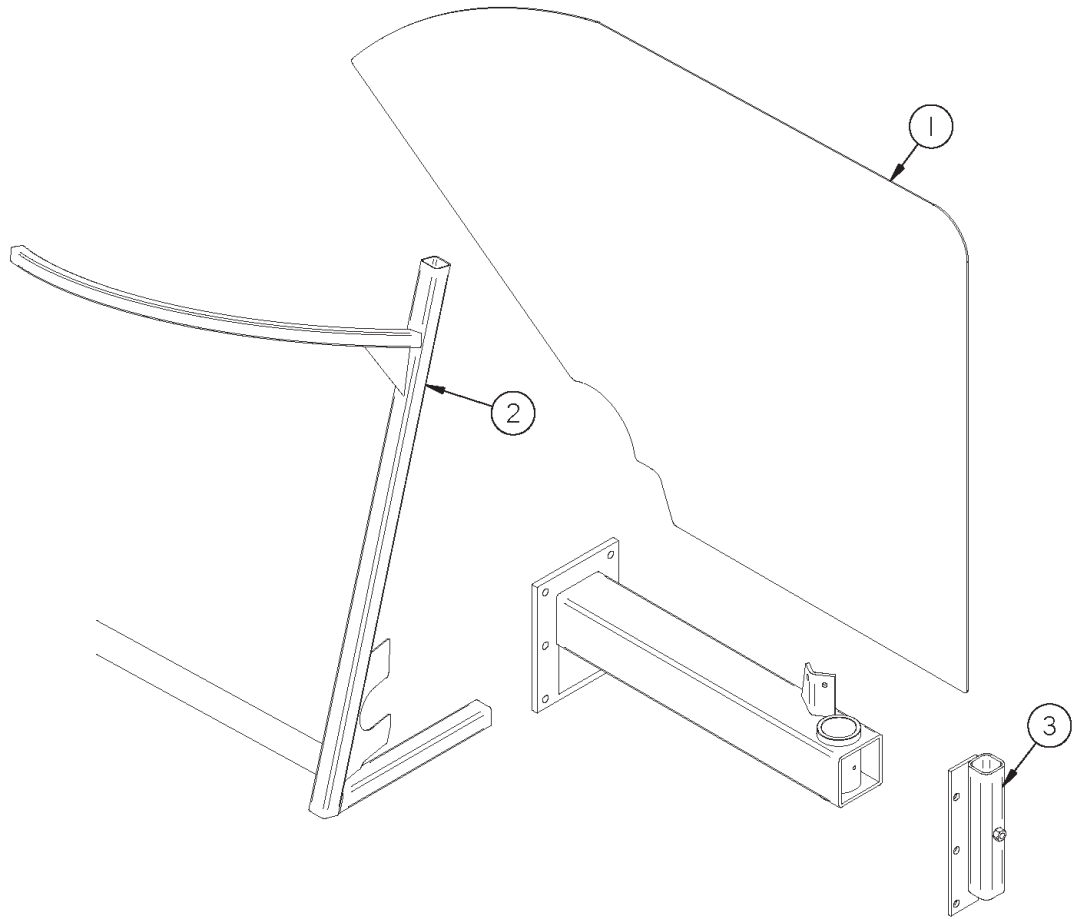

<u>ITEM</u>	<u>PART #</u>	<u>DESCRIPTION</u>
1	SWM50	WINDROW INVERTER POLY
2	SWM51	WINDROW INVERTER FRAME
3	SWM52	STORAGE MOUNT

NOTE: STORAGE MOUNT BOLTS ONTO SWM3 CASTER MOUNT - SEE FIG 1 ITEM #20

FIGURE 10
OPTIONAL ACCELERATOR

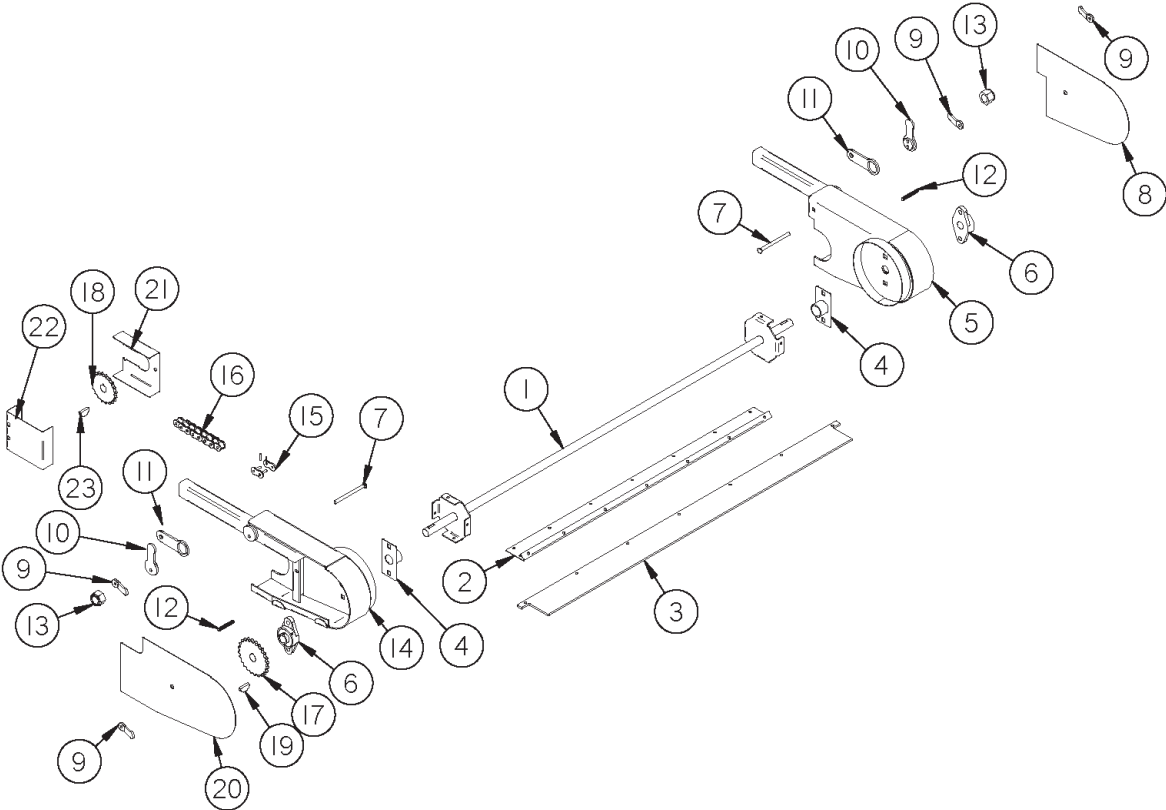

FIGURE 10

OPTIONAL ACCELERATOR

<u>ITEM</u>	<u>PART #</u>	<u>DESCRIPTION</u>
1	SWM42	ACCELERATOR SHAFT
2	SWM43	ACCELERATOR PLATE
3	SWM44	RUBBER
4	DWM211	WRAP GUARD
5	DWM208	MOUNTING BRACKET 1
6	DWM221	1" BEARING
7	YBCR12122	3/8" X 5-1/2" CARRIAGE BOLT GR. 5
8	DWM214	SHIELD 1
9	DWM219	HANDLE NUT
10	DWM210	LATCH HANDLE
11	DWM217	LATCH
12	DWM218	READY ROD
13	YNNY12005	3/8" NYLOCK NUT
14	DWM209	MOUNTING BRACKET 2
15	X61	#50 CONNECTOR LINK
16	SWM53	#50 ROLLER CHAIN 57 PITCH
17	X106	SPROCKET 24T 1" BORE
18	SWM45	SPROCKET 17T 1-1/4" BORE
19	5B10	WOODRUFF KEY 1/4" X 1"
20	DWM213	SHIELD
21	DWM216	SPROCKET SHIELD BACK
22	DWM215	SPROCKET SHIELD
23	S135	1/4" X 1-1/4" SQ. KEY

FIGURE 11
2' EXTENSION

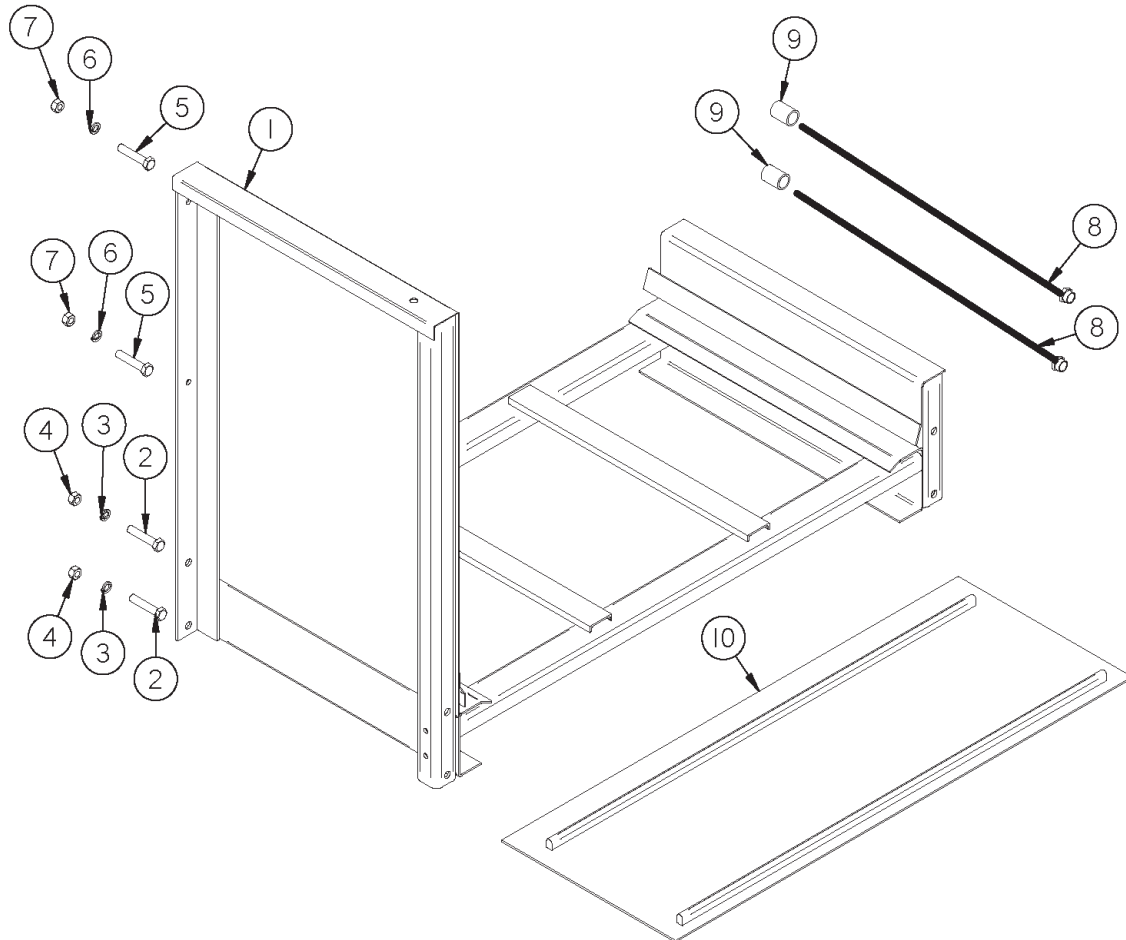

FIGURE 11
2' EXTENSION

<u>ITEM</u>	<u>PART #</u>	<u>DESCRIPTION</u>
1	SWM62	EXTENSION
2	YBHH16100	1/2" X 2-3/4" BOLT GR. 5
3	YWLO16005	1/2" LOCK WASHER
4	YNHX16005	1/2" NUT
5	YBHH12110	3/8" X 2-3/4" BOLT GR. 5
6	YWLO12005	3/8" LOCK WASHER
7	YNHX12005	3/8" NUT
8	16SV141	1/2" X 24" HOSE (1/2"MP & 1/2"MPX)
9	PB105	1/2" PIPE COUPLER
10	WM214	BELT EXTENSION
*	WM220	LACING PIN

NOTE: * MEANS NOT SHOWN

FIGURE 12

OPTIONAL WET KIT

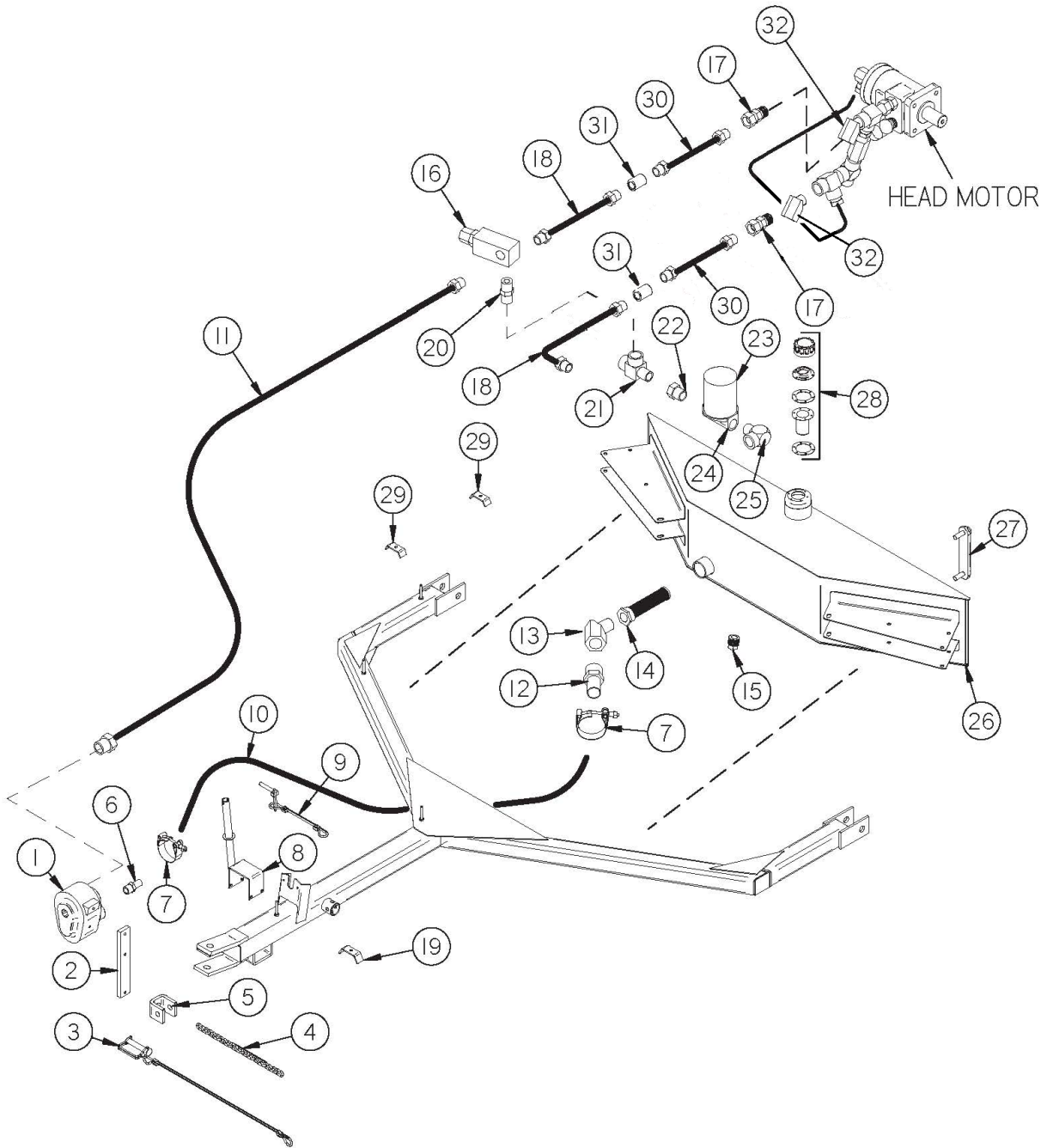

FIGURE 12

OPTIONAL WET KIT

<u>ITEM</u>	<u>PART #</u>	<u>DESCRIPTION</u>
1	HSW4	PTO PUMP (REAR PORTS)
2	WM168	TORQUE ARM
3	HSW20	PUMP CHAIN LANYARD
4	BFR111	18 LINKS 1/4" PROOF CHAIN
5	HSW5	CHAIN YOKE
6	HSW9	SAE 16 X 1-1/4" HOSE BARB
7	DWM138	HOSE CLAMP (FIT OVER 1-3/4"OD)
8	SWMW1	STORAGE BRACKET
9	S122	CLIP PIN CABLE W/ LANYARD
10	SWMW2	1-1/4" X 76" SUCTION HOSE
11	SWMW3	3/4" X 108" HYDRAULIC HOSE #12 SAE SWIVEL & 1/2"MP
12	DWM143	1-1/4" HOSE BARB
13	DWM118	45° STREET 1-1/4" ELBOW
14	HSW2	SUMP STRAINER
15	DWM159	3/4" SQUARE HEAD PLUG/MAGNET
16	56348	RELIEF VALVE
17	LW174	1/2" MALE UNION ADAPTER
18	SWMW4	3/4" X 84" HYDRAULIC HOSE 1/2"MP & 1/2"MP
19	T223	HOSE CLAMP
20	WM141	NIPPLE NUT 1/2"
21	LW96	SERVICE TEE 1/2"
22	LW99	3/4" TO 1/2" BUSHING
23	LW289	FILTER
24	LW119	FILTER BASE
25	33SV72	3/4" STREET ELBOW
26	SWMW5	TANK
27	DWM204	OIL LEVEL GAUGE
28	DWM81	FILLER CAP ASSEMBLY
29	HE42	HOSE CLAMP
30	SWMW6	3/4" X 30" HYDRAULIC HOSE 1/2"MP & 1/2"MP
31	LW346	1/2" PIPE COUPLER
32	LW187	45° STREET ELBOW 1/2"

H&S MFG. CO.

products approved

for the

FEMA

SEAL OF QUALITY

