

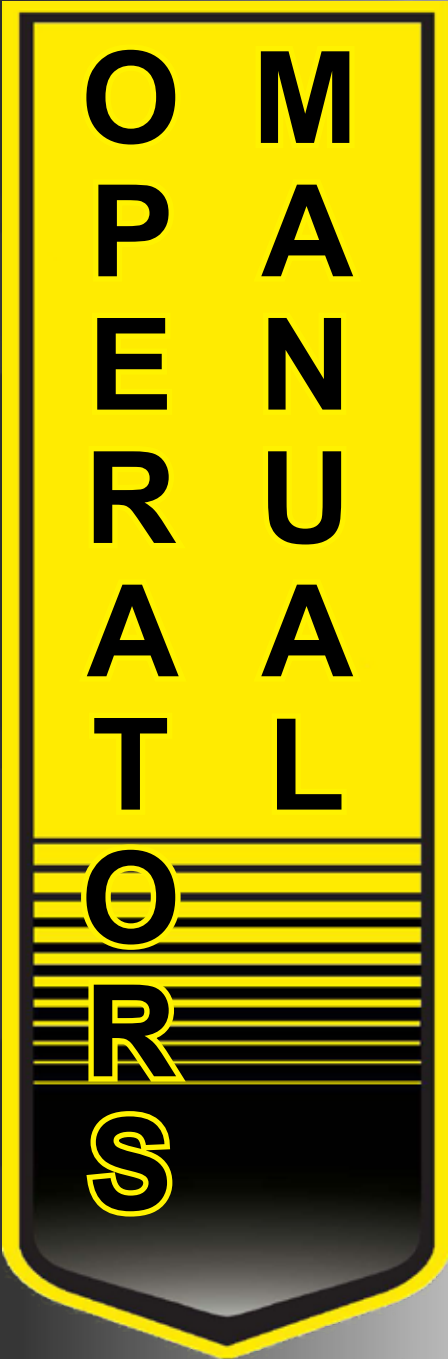

**3231/3237/3243  
HEAVY-DUTY  
SPREADER**



**WARNING**

READ AND UNDERSTAND THIS MANUAL BEFORE OPERATING THIS EQUIPMENT. UNSAFE OPERATION OR MAINTENANCE OF THIS EQUIPMENT CAN RESULT IN SERIOUS INJURY OR DEATH.

3231 Starting Serial #322MS31031  
3237 Starting Serial #322MS37026  
3243 Starting Serial #322MS43036

Part#85974

Rev. #02

HSMFG122122

**STRONG HERITAGE - STRONG PEOPLE - STRONGER FUTURE**

# **CONTENTS**

Warranty . . . . .	1
Manufacturer's Statement . . . . .	2
Warranty Registration Form . . . . .	3
Dealer Pre-Delivery Checklist . . . . .	5
Dealer Delivery Checklist . . . . .	7
Safety Information - Be Alert Symbol . . . . .	9
Explanation of Safety Signs . . . . .	10
Safety Decals . . . . .	11-12
Safety Information - Warning - Owner Must Read and Understand . . . . .	13
Cap Screw Torque Values . . . . .	14
Set-Up & Assembly . . . . .	15
Transporting . . . . .	15
Preparing for Operation . . . . .	16
Operation . . . . .	17-18
Adjustments . . . . .	18-20
Service . . . . .	21
Optional Equipment . . . . .	22-23
Lubrication Guide . . . . .	24-25
Decal Location . . . . .	26-29
Troubleshooting . . . . .	30
Service Notes . . . . .	31-32

## **H&S WARRANTY**

H&S Manufacturing Co., Inc. ("H&S") warrants this product to be free from defect in material and workmanship. Except as noted below, this warranty term is twelve (12) months on parts and labor, and twenty-four (24) months on parts only from the date of delivery of the product to the original purchaser by an authorized H&S dealer. Under this warranty, H&S will repair or replace, at its option, any covered part which is found to be defective in material or workmanship during the applicable warranty term. In no case will the covered repair cost of a part or parts exceed the replacement cost of that part. In no case, unless pre-authorized by H&S, will a component be replaced versus repaired unless the cost of labor and parts exceeds 75% of the cost of a new component. Warranty repairs must be performed by H&S or a dealer authorized by H&S to sell and/or service the product involved, and will use only new or remanufactured parts or components furnished by H&S. Any warranty repairs needing to be performed by a third party must be pre-authorized by H&S. Standard freight costs will be covered by H&S for any part used to make a warrantable repair, any form of express freight will not be covered unless pre-authorized by H&S. This warranty includes approved parts and labor to repair the product but does not include, and the purchaser is responsible for, any service call and/or transportation of the product to and from the dealer's place of business, for any costs related to travel, for any premium charged for overtime labor requested by the purchaser, and for any service work not directly related to any defect covered under this warranty.

This warranty includes only those components of the product manufactured by H&S. Warranty for any component not manufactured by H&S including, but not limited to, engines, batteries, tires, rims, hydraulic motors, pumps, etc. are covered by the warranty, if any, provided separately by their respective manufacturers. H&S reserves the right to request the return of any failed component.

This warranty in all its parts is extended solely to the original purchaser of the product, is terminated upon any subsequent transfer or sale from or by the original purchaser, and extends no third party benefits or rights whatsoever.

The warranty term for any product used in any for hire, rental fleet or rental application, is limited to six (6) months from the date of delivery of the product to the original purchaser by an authorized H&S dealer.

This warranty does not include: (1) Any product that has been altered or modified in ways not approved by H&S; (2) Depreciation or damage caused by normal wear, use for which the product was not designed, misuse, improper or insufficient maintenance, improper operation, accident or failure to follow the product Operator's Manual recommendations and product decal recommendations; (3) Normal maintenance parts and service; (4) Repairs made with parts other than those available from H&S or performed by anyone other than H&S or a dealer authorized by H&S to sell and/or service the product involved.

To secure warranty service the purchaser must report the product defect to a dealer authorized by H&S to sell and/or service the product involved within the applicable warranty term together with evidence of the warranty start date and make the product available to that dealer within a reasonable period of time.

For these warranty terms to be in effect the selling authorized H&S dealer and/or the customer must submit the warranty registration to H&S.

THERE ARE NO WARRANTIES WHICH EXTEND BEYOND THE DESCRIPTION ON THE FACE OF THIS WARRANTY. H&S and the companies affiliated with it make no warranties, representations, or promises, express or implied, as to the performance or freedom from defect of its products other than those set forth above and NO IMPLIED WARRANTY OF MERCHANTABILITY, FITNESS OR FITNESS FOR A PARTICULAR PURPOSE IS MADE. IN NO EVENT WILL THE DEALER, H&S OR ANY COMPANY AFFILIATED WITH H&S BE LIABLE FOR INCIDENTAL OR CONSEQUENTIAL DAMAGES. The ONLY REMEDY the purchaser has in connection with the breach of performance of any warranty on H&S products are those set forth above.

The selling dealer has no authority to make any representation or promise on behalf of H&S, or to modify the terms or limitations of this warranty in any way.

12/20/22

## **MANUFACTURER'S STATEMENT**

Your New H&S Product has been manufactured of the finest quality materials and components. The performance you get from your machine is largely dependent upon how well you read and understand this manual and apply this knowledge. There is a right and a wrong way to do everything. Please do not assume that you know how to operate and maintain your Machine before reading this manual carefully. Keep this manual available for ready reference.

H&S reserves the right to make changes or add improvements to its products at any time without incurring any obligation to make such changes to products previously manufactured. Specifications, statements and descriptions of Products contained in this publication are subject to change without prior notification.

## WARRANTY REGISTRATION

- Date of Purchase: \_\_\_\_\_
- Purchaser Name: \_\_\_\_\_
- Street Address: \_\_\_\_\_
- City: \_\_\_\_\_
- State: \_\_\_\_\_ Zip: \_\_\_\_\_
- Phone Number: \_\_\_\_\_
- E-mail Address: \_\_\_\_\_
- Product: \_\_\_\_\_
- Model Number: \_\_\_\_\_
- Serial Number: \_\_\_\_\_
- You have received the Operator's Manual for this product. Yes \_\_\_\_\_ No \_\_\_\_\_
- Interested in receiving the H&S E-mail Newsletter? Yes \_\_\_\_\_ No \_\_\_\_\_

- 
- Dealer Name: \_\_\_\_\_
  - Street Address: \_\_\_\_\_
  - City: \_\_\_\_\_
  - State: \_\_\_\_\_ Zip: \_\_\_\_\_
  - Signature: \_\_\_\_\_

- All fields must be filled out to ensure prompt notification of product and/or warranty updates.

**Please mail the completed WARRANTY REGISTRATION FORM to:  
H&S Manufacturing Co., Inc.  
2608 S. Hume Ave.  
Marshfield, WI 54449**

**Intentionally Left Blank**

# H&S DEALER PRE-DELIVERY CHECKLIST

## **AFTER COMPLETION, DEALER SHOULD REMOVE AND RETAIN FOR RECORDS**

After the Manure Spreader has been completely set up, check to be certain it is in correct operating order before delivering to the customer. The following is a list of points to inspect. Check off each item as you have made the proper adjustments and found the item operating satisfactorily.

- Manure Spreader was not damaged in shipment. Check for dents and loose or missing parts. Report damage immediately to H&S Manufacturing Co., Inc.
- Manure Spreader has been correctly assembled according to instructions in this manual.
- All bolts and fasteners are tight.
- All shields and guards are in place and secured.
- All grease fittings have been lubricated. Gearbox is filled to proper levels. See Lubrication Chapter of this manual for details.
- Hoses and fittings if applicable, are properly attached and there are no visible leaks.
- All drive chains are adjusted to proper tension. See Adjustment Chapter of this manual.
- Decals are in place and legible.
- Connect the Manure Spreader to a tractor and attach the PTO and make sure that the PTO guards turns freely.
- Connect the lights to the tractor if applicable. Lights and wiring functioning properly.
- Run the Manure Spreader and make sure all components operate properly.
- Hydraulic system if applicable, does not leak under pressure.

Model Number \_\_\_\_\_

Serial Number \_\_\_\_\_

Dealer's Name \_\_\_\_\_

Inspection Date \_\_\_\_\_

Signature of Pre-Delivery Inspector \_\_\_\_\_

(Remove Dealer File Copy At Perforation)

**Intentionally Left Blank**



# **DEALER DELIVERY CHECKLIST**

## **AFTER COMPLETION, DEALER SHOULD REMOVE AND RETAIN FOR RECORDS**

This checklist that follows is an important reminder of valuable information that should be passed on to the customer at the time this Manure Spreader is delivered.

Check off each item as you explain it to the customer.

This delivery checklist, when properly filled out and signed assures the customer that the pre-delivery service was satisfactorily performed.

- Explain to the customer that the pre-delivery inspection was made.
- Explain to the customer all the safety precautions they must exercise when operating this unit.
- Explain recommended loads for different types of materials.
- Explain to customer that regular lubrication is required for proper operation and long life of machine.
- Show customer the lubrication section of Owner's Manual.
- Give the customer Owner's Manual and make sure they read and understand all operating and service instructions.
- Have customer sign a completed "Warranty Registration" and mail it promptly.

Date Delivered \_\_\_\_\_

Dealer's Name \_\_\_\_\_

By \_\_\_\_\_

Signature of Original Buyer \_\_\_\_\_

Note: Warranty is not valid until warranty card is completed and returned to H&S Mfg. Co., Inc.

**Intentionally Left Blank**

**SAFETY INFORMATION**



**BE  
ALERT!**

**YOUR SAFETY  
IS INVOLVED.**

**THIS SYMBOL IS USED THROUGHOUT THIS BOOK WHENEVER YOUR PERSONAL SAFETY IS INVOLVED. TAKE TIME TO BE CAREFUL. REMEMBER: THE CAREFUL OPERATOR IS THE BEST OPERATOR. MOST ACCIDENTS ARE CAUSED BY HUMAN ERROR. CERTAIN PRECAUTIONS MUST BE OBSERVED TO PREVENT THE POSSIBILITY OF INJURY OR DAMAGE.**

**H&S MANUFACTURING CO., INC.**

# SAFETY INFORMATION

Keep signs in good condition. Immediately replace any missing or damaged signs.

## RECOGNIZE SAFETY INFORMATION

This is the safety alert symbol. When you see this symbol on your machine or in this manual, be alert to the potential for personal injury.

Follow recommended precautions and safe operating practices.



## UNDERSTAND SIGNAL WORDS

A single word - DANGER, WARNING, or CAUTION - is used with the safety alert symbol. DANGER identifies the most serious hazards.

Safety signs with a single word DANGER or WARNING are typically near specific hazards.

General precautions are listed on CAUTION safety signs.



**WARNING**



**CAUTION**



# CAUTION

## FOLLOW SAFETY INSTRUCTIONS

Carefully read all safety messages in this manual, and all safety signs on your machine. Follow all recommended precautions and safe operating procedures.

## OBSERVE MAXIMUM TRANSPORT SPEED

**The maximum transport speed for this implement is 32 km/h (20 mph).**

Some tractors are capable of operating at speeds that exceed the maximum transport speed of this implement. Regardless of the maximum speed capability of the tractor being used to tow this implement, do not exceed the implement's maximum transport speed.

Exceeding the implement's maximum transport speed can result in:

- \* Loss of control of the tractor/implement combination
- \* Reduced or no ability to stop during braking
- \* Implement tire failure
- \* Damage to the implement structure or its components

Use additional caution and reduce speed when towing under adverse surface conditions, when turning, and when on inclines.

Do not attempt transport if the fully loaded implement weighs more than 1.5 times the weight of the tractor.



# SAFETY INFORMATION

	<div style="background-color: #cccccc; padding: 2px; text-align: center;"><b>! WARNING</b></div> <p style="text-align: center;"><b>DO NOT OPERATE THIS EQUIPMENT IF THIS DECAL IS EXPOSED. REPLACE SAFETY SHIELDS.</b></p> <p style="text-align: right; font-size: small;">1494A</p>
---	--

<b>! DANGER</b>

<p style="text-align: center;"><b>ROTATING DRIVELINE CONTACT CAN CAUSE DEATH KEEP AWAY!</b></p> <p style="text-align: center;"><b>DO NOT OPERATE WITHOUT-</b></p> <ul style="list-style-type: none"> <li>• ALL DRIVELINE, TRACTOR AND EQUIPMENT SHIELDS IN PLACE.</li> <li>• DRIVELINES SECURELY ATTACHED AT BOTH ENDS.</li> <li>• DRIVELINE SHIELDS THAT TURN FREELY ON DRIVELINE.</li> </ul> <p style="text-align: right; font-size: x-small;">1494L</p>

	<div style="background-color: #cccccc; padding: 2px; text-align: center;"><b>! WARNING</b></div> <p style="text-align: center;"><b>DO NOT GO NEAR LEAKS</b></p> <ul style="list-style-type: none"> <li>• High pressure oil easily punctures skin causing serious injury, gangrene or death.</li> <li>• If injured, seek emergency medical help. Immediate surgery is required to remove oil.</li> <li>• Do not use finger or skin to check for leaks.</li> <li>• Lower load or relieve hydraulic pressure before loosening fittings.</li> </ul> <p style="text-align: right; font-size: x-small;">11599</p>
---	---

<b>! WARNING</b>		
		
<p style="text-align: center;"><b>CRUSHING HAZARD</b></p> <p style="text-align: center;"><b>TO PREVENT SERIOUS INJURY OR DEATH:</b></p> <p style="text-align: center;"><b>KEEP HANDS AND BODY OUT OF HITCH AREA WHEN ATTACHING TOWING VEHICLE.</b></p> <p style="text-align: center;"><b>KEEP BODY CLEAR OF CRUSH POINT BETWEEN TOWING VEHICLE AND LOAD.</b></p> <p style="text-align: center;"><b>KEEP FEET AND LEGS CLEAR FROM UNDER TONGUE AREA IN CASE OF POSSIBLE JACK FAILURE.</b></p> <p style="text-align: right; font-size: x-small;">82602</p>		

	<div style="background-color: #cccccc; padding: 2px; text-align: center;"><b>! WARNING</b></div> <p style="text-align: center;"><b>DO NOT REMOVE SHIELDS ROTATING PARTS INSIDE</b></p> <p style="text-align: right; font-size: x-small;">12794</p>
--	--

	<div style="background-color: #cccccc; padding: 2px; text-align: center;"><b>! WARNING</b></div> <p style="text-align: center;"><b>DO NOT OPERATE THIS EQUIPMENT IF THIS DECAL IS EXPOSED. REPLACE SAFETY SHIELDS.</b></p> <p style="text-align: right; font-size: x-small;">71494A</p>
---	---

<b>! WARNING</b>
<p style="text-align: center;"><b>HELP AVOID INJURY</b></p> <ul style="list-style-type: none"> <li>• READ &amp; UNDERSTAND THE OPERATORS MANUAL PROVIDED WITH THIS MACHINE. IF MISPLACED CALL H &amp; S MANUFACTURING AT 715-387-3414 WITH MODEL AND SERIAL NUMBER.</li> <li>• UNDERSTAND ALL SAFETY WARNINGS AND FUNCTION OF CONTROLS.</li> <li>• KEEP SAFETY DEVICES IN PLACE AND WORKING.</li> <li>• KEEP YOURSELF AND OTHERS WELL CLEAR OF MOVING PARTS.</li> <li>• DISCONNECT ALL POWER BEFORE SERVICING OR CLEANING THIS MACHINE.</li> <li>• DO NOT EXCEED 20 MPH</li> </ul> <p style="text-align: right; font-size: x-small;">72203A</p>

# SAFETY INFORMATION



1494B

**⚠ WARNING**

**DO NOT REMOVE SHIELDS**  
**MOVING PARTS INSIDE**

**⚠ DANGER**



**NEVER ALLOW RIDERS ON THIS MACHINE**

9194B



**⚠ WARNING**



**⚠ DANGER**

**NO STEP-STAY CLEAR**

9194A



**⚠ WARNING**

**DO NOT REMOVE SHIELDS**  
**MOVING PARTS INSIDE**

1494K



**⚠ DANGER**

**STAY CLEAR OF END GATE ARMS**

111593C

**DO NOT CLEAN OR WORK ON THIS MACHINE WITHOUT FIRST DISENGAGING POWER AND SHUTTING OFF TRACTOR ENGINE.**

1494J



111593A

**⚠ DANGER**

**STAY CLEAR OF BEATER IF TRACTOR OR PTO IS RUNNING**  
**BEATER SHUT OFF COULD ACCIDENTALLY BE ENGAGED**

**FAILURE TO HEED THIS WARNING MAY RESULT IN PERSONAL INJURY OR DEATH**

**KEEP CLOTHING, YOURSELF AND OTHERS WELL CLEAR**

# SAFETY INFORMATION

## TRACTOR:

This operator's manual uses the term "Tractor" when identifying the power or the towing source.



## TO PREVENT SERIOUS INJURY OR DEATH

BEFORE YOU ATTEMPT TO OPERATE THIS EQUIPMENT, READ AND STUDY THE FOLLOWING INFORMATION. IN ADDITION, MAKE SURE THAT EVERY INDIVIDUAL WHO OPERATES OR WORKS WITH THIS EQUIPMENT, WHETHER FAMILY MEMBER OR EMPLOYEE, IS FAMILIAR WITH THESE SAFETY PRECAUTIONS.

KNOW HOW TO STOP UNLOADING MECHANISM BEFORE STARTING IT.

If the machine becomes clogged, disengage the PTO. Stop the tractor engine, remove ignition key, and allow all mechanisms to stop before cleaning or working on the machine.

**DO NOT** get off the tractor while the Manure Spreader is in operation.

**DO NOT** attempt to perform maintenance or repair with tractor running and PTO or hydraulic lines hooked up.

**DO NOT** step up on machine at any time.

**NEVER** manually feed material into the beaters.

**DO NOT** allow minors to operate or be near the machine.

**DO NOT ALLOW PERSONNEL OTHER THAN THE QUALIFIED OPERATOR NEAR THE MACHINE.**

Before starting tractor, be sure PTO shields turn freely and PTO is securely locked to tractor.

**DO NOT** clean, adjust, or lubricate the machine when any part is in operation.

Keep hands, feet, and clothing away from beaters when they are revolving.

Loose or floppy clothing should not be worn by the operator.

Be sure the machine is clear of people, tools, and other objects before engaging PTO.

**DO NOT** step over power take off shaft. Stay clear of PTO at all times.

**NEVER** start Manure Spreader until all guards and safety shields are secured in place.

**STAY CLEAR** of Hydraulic Lines. They may be under extreme pressure or heat.

H&S always takes the operator and their safety into consideration and guards exposed moving parts for their protection. However, some areas cannot be guarded or shielded in order to assure proper operation. In addition, the operator's manual and decals on the machine itself warn you of further danger and should be read and observed closely.

## Study The Above Safety Rules

# ATTENTION - BE ALERT - YOUR SAFETY IS INVOLVED

# CAP SCREW TORQUE VALUES

The specifications below are the torque values for fasteners as it adheres to the SAE torque value standards. All fasteners should be torqued to the proper values found in the figures below unless otherwise specified by the engineering drawing.

- Lubed torque would be any fastener that has grease, liquid Loctite, oil, etc. on the threads.
- Dry torque would be any fastener which has threads that are clean and dry and do not have any liquid Loctite or grease on them.

## Hex Head Fasteners

The figure shown below shows how to determine what SAE grade a fastener is.

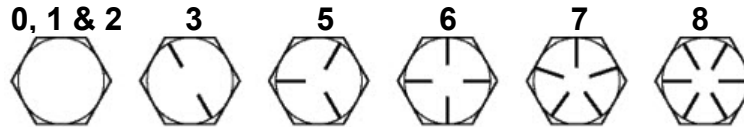

SUGGESTED ASSEMBLY TORQUE VALUES							WORKING TORQUE			
SAE GR. 2-6"		SAE GR. 5		SAE GR. 8			18-8 SS	316 SS	Brass	Silicon Bronze
Dia. & Thrds. per inch	Dry Ft. Lbs.	Lube Ft. Lbs.	Dry Ft. Lbs.	Lube Ft. Lbs.	Dry Ft. Lbs.	Lube Ft. Lbs.	Inch Lbs.	Inch Lbs.	Inch Lbs.	Inch Lbs.
1/4-20	5.5	4.2	8	6.3	12	9	75.2	78.8	61.5	68.6
1/4-28	6.3	4.7	10	7.2	14	10	94.0	99.0	77.0	87.0
5/16-20	11	8	17	13	24	18	132	138	107	123
5/16-28	12	9	19	14	27	20	142	147	116	131
3/8-16	20	15	30	23	45	35	236	247	192	219
3/8-24	23	17	35	25	50	35	259	271	212	240
7/16-14	32	24	50	35	70	50	376	393	317	349
7/16-20	36	27	55	40	80	60	400	418	327	371
1/2-13	50	35	75	55	110	80	517	542	422	480
1/2-20	55	40	85	65	120	90	541	565	443	502
9/16-12	70	55	110	80	150	110	682	713	558	632
9/16-18	80	60	120	90	170	130	752	787	615	697
5/8-11	100	75	150	110	210	160	1110	1160	907	1030
5/8-18	110	85	170	130	240	180	1244	1301	1016	1154
3/4-10	175	130	260	200	380	280	1530	1582	1249	1416
3/4-16	200	140	300	220	420	310	1490	1558	1220	1382
7/8-9	170	125	430	320	600	450	2328	2430	1905	2140
7/8-14	180	140	470	350	670	500	2318	2420	1895	2130
1-8	250	190	640	480	910	680	3440	3595	2815	3185
1-14	280	210	720	540	1020	760	3110	3250	2545	2885



# **SET-UP & ASSEMBLY**

**Note: Determine right and left side of spreader by viewing it from the rear. If instructions or parts lists call for hardened bolts, refer to Cap Screw Torque Values page to identify.**

## **PREPARING MANURE SPREADER**

The Manure Spreader may be shipped without the wheels/tires installed.

1. Attach the wheels with tires, using the lug nuts furnished and torque the mounting hardware to the appropriate torque. Wheel bolts should be tightened at 100 ft./lbs. of torque.
2. Check the tires and inflate to the recommended pressure (295/75RX22.5 tires to 75 to 80 psi. - 16.5 x 16.1 tires to 36 psi.)
3. Check for proper assembly and adjustment and make sure that all bolts are tightened.
4. Securely retighten after a few hours of operation, as bolts can loosen up on new machinery.
5. Lubricate the machine completely, check the oil level of the gearbox, fill if necessary.

## **TRANSPORTING**

### **REFLECTORS/SMV**

There is a holder provided for your SMV sign. Unless otherwise prohibited, use a slow-moving vehicle emblem. Never tow the manure spreader on a public highway at a speed greater than 20 mph (32 kph). Regularly clean the reflective tape at the rear of the spreader.

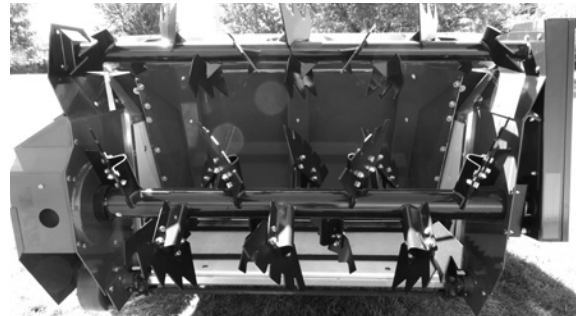

(Shown w/optional upper beater on 3231/3237)

### **LIGHTING (Optional)**

When transporting on the highway, connect the spreader to the tractor with a lighting power cord. The optional lighting system is to be connected to the 7-pin power receptacle (per SAEJ560B) on your tractor. If your tractor is not equipped with the proper receptacle, see your tractor dealer for details. Make sure lights are functioning properly.

### **SAFETY CHAIN (Optional)**

Follow state and local regulations regarding use of a safety chain and transport lighting when towing farm equipment on public highways. A proper safety chain should be used to retain the safety connection between the towing and towed machines, in the event of separation of the primary attaching system. Check with local law enforcement agencies for your own particular regulations. Never tow the manure spreader on a public highway at a speed greater than 20 mph (32 kph).

1. Chain is sufficiently slack to allow turns and movements of either the tractor or the manure spreader without placing tension on the chain.
2. Chain is of sufficient strength to hold the decoupled implement (and its load) and tow it to the shoulder.

# PREPARING FOR OPERATION

## TRACTOR CONNECTIONS

### Tractor Hitch

Fasten the spreader hitch to the drawbar with a **hitch pin with a safety locking device**. Remove the weight from the jack (jack is not to be used when spreader is loaded). Remove jack from pipe mount and place on convenient storage mount located on the top of left hitch channel. This allows protection of jack from tractor tires during turns. The hitch of the spreader is designed for a standardized tractor hitch. Adjust the drawbar so that it is 13 to 17 inches above the ground. Extend or shorten it so that the horizontal distance from the end of the tractor power takeoff shaft to the center of the hitch pin hole is 14 inches for 540 PTO and 15-3/4" for 1000 PTO as shown in drawing. An improperly located hitch point may cause damage to the universal joints of the power takeoff. Secure the drawbar so that the hitch pin hole is directly below the power drive line.

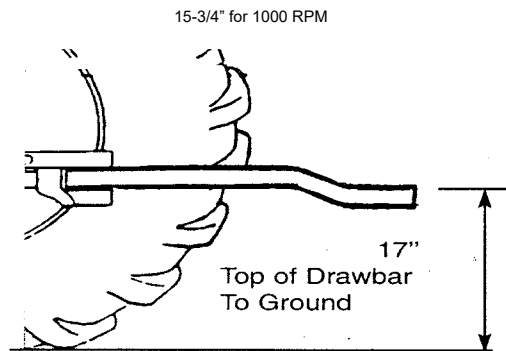

### PTO

Attach the PTO of the spreader to the tractor by sliding the spring loaded locking collar on PTO yoke rearward, then sliding it onto the tractor PTO shaft. Release spring loaded collar. Be sure the pins fall into the groove of the tractor PTO shaft and collar snaps forward into locking position.

**CAUTION:** Do not use a steel hammer to aid in joining PTO parts.

*If this implement is attached to a tractor with a clevis hitch (hammer-strap) style drawbar, the hammer-strap must be removed to prevent damage to the IID guarding and the IID telescoping members. [See Figure 1]*

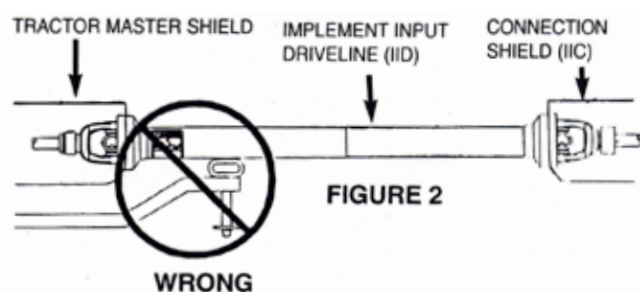
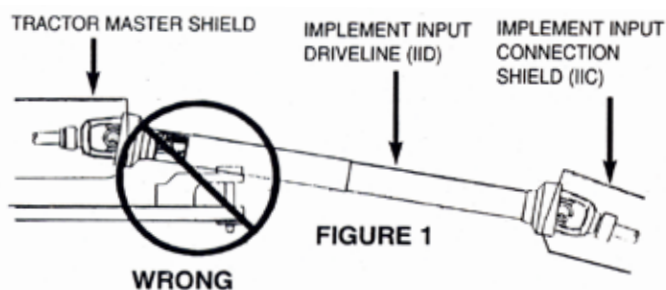

*If this implement is attached to a tractor with an offset in the drawbar, be certain it is in the down position to prevent damage to the IID guarding and the IID telescoping members. [See Figure 2]*

### Manure Spreader Speed Control

Attach the manure spreader speed control/beater engage/disengage rope to a convenient point on the tractor.

# OPERATION

## EMERGENCY SHUTDOWN

If a foreign object becomes lodged in the beater area and shears the shear bolt, disengage the PTO. Stop the tractor engine, remove the ignition key, and allow all mechanisms to stop before cleaning or working on the spreader.



**WARNING:** Some photographs used in the following pages show guards or shields removed for clarification. **NEVER** operate machine until these guards or shields are in proper operating position.

## LOADING

In freezing weather, make certain that hydraulic tail gate (if equipped with one) is not frozen to the sides or on the floor of the spreader. Make sure the apron chain is not frozen to the spreader floor or any lumps of manure are frozen to the floor. Begin loading the spreader at the front end and work toward the rear until loading is completed. Loading this way permits the material to be spread uniformly. Loading front to rear is particularly important when the spreader is loaded by a mechanical loader because this type of load requires more power to spread than others loads. When hauling extremely heavy materials with a large portion of dirt, it may be necessary to reduce the load size to prevent excessive shear bolt breakage. Never dump material onto the beater. Do not use extra sideboards. Do not overload spreader. Overloading decreases spreading effectiveness. Do not load more than 15 inches above the beater.

## SPREADING - 2 SPEED

**NOTE:** Two speed drive mechanism and beater engage/disengage are controlled by one rope leading to the tractor.

1. When ready to unload, make sure beater is in the engaged position and low speed indicator is visible through low speed hole in panel of spreader.
2. Raise the hydraulic endgate.
3. Engage the tractor PTO shaft slowly.
4. Increased apron speed, if desired, can be accomplished by steadily pulling on the rope until it stops. Speed select indicator should now be visible through the high speed hole. Beater will continue to operate and apron speed will be increased.
5. When the Manure Spreader is almost empty, the bed can be cleaned by shifting into clean out position. Apply a steady pull on the rope until it stops and speed indicator is visible in the clean out hole. In this position, the beater will stop and the apron will continue to operate at the same speed as in high speed position, thus saving unnecessary driving.
6. When spreader is empty, shut off tractor PTO. Pull control rope until speed select indicator snaps into low speed. This will re-engage beater for the next load. DO NOT SHIFT FROM CLEAN OUT TO LOW SPEED WITH THE TRACTOR PTO RUNNING.
7. Do not operate the Manure Spreader with a PTO speed greater than 540 RPMs unless necessary sprocket changes have been made.

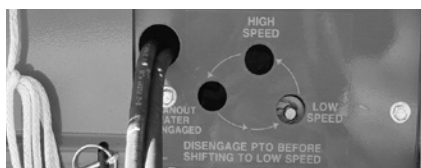

Low Speed

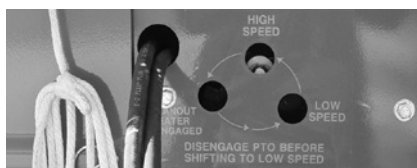

High Speed

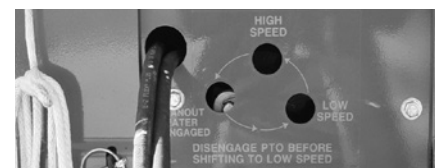

Clean Out

# OPERATION

## SPREADING - WITH OPTIONAL HYDRAULIC DRIVE

1. Engage tractor PTO shaft slowly. Beater is always in the engaged position, therefore, engaging tractor PTO will automatically start beater.
2. Raise the hydraulic tailgate.
3. Open hydraulic valve on tractor connected to speed control valve on Manure Spreader.
4. Control speed of apron by turning speed control handle clockwise to increase speed, counter-clockwise to decrease speed.
5. When the Manure Spreader is almost empty, the bed can be cleaned out by disengaging tractor PTO (which will stop beater), and increasing apron speed by turning control handle clockwise, thus saving unnecessary driving time.

**FAILURE TO FOLLOW THE RECOMMENDED ADJUSTMENTS WILL VOID WARRANTY**

## ADJUSTMENTS

### DRIVE CHAIN

To adjust front drive chain, loosen jam nut turn nut on adjusting rod (located at the right hand front side of spreader) clockwise. There should be 1/2" deflection at the center of the drive chain. Over tightening or too loose of a chain will result in excessive wear on the bearing, chain and sprockets. Retighten jam nut.

**Tightener Bolt**

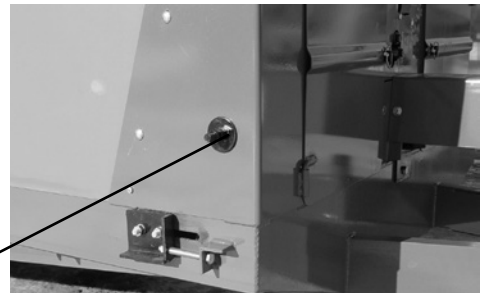

### APRON SPEED AND BEATER CONTROL

One cable controls both the beater clutch and two speed clutch. To compensate for wear or stretching of this cable, adjust the turnbuckle behind shield at the front of the spreader.

**Turnbuckle**

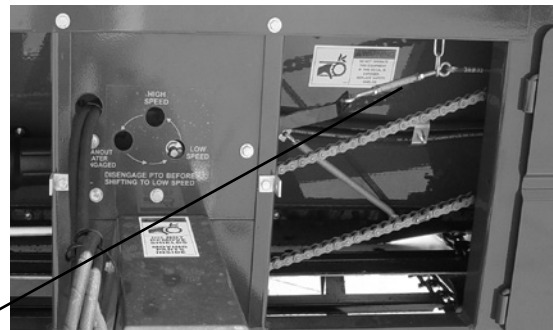

**Shields Removed for Clarity**

### WHEEL HUBS

To adjust wheel hubs, tighten the castellated nut on the spindle to the point where there is no end-play and a slight drag on the bearings. Replace the cotter key with a new one of the correct size.

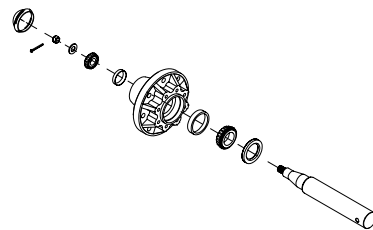

# ADJUSTMENTS

## TWO SPEED CLUTCH

If clutch control yoke becomes worn, it may be necessary to adjust the high speed clutch so it engages and disengages completely. Adjustment to compensate for this wear is made by sliding spring stop (A) on the control rod closer to the clutch engaging lever. Initial adjustment should be made as follows: Distance between the washers on each end of the spring is 5-1/2".

There should not be any space between the jam nut and shifting rod bracket. If there is, adjust the turnbuckle at the front of the spreader.

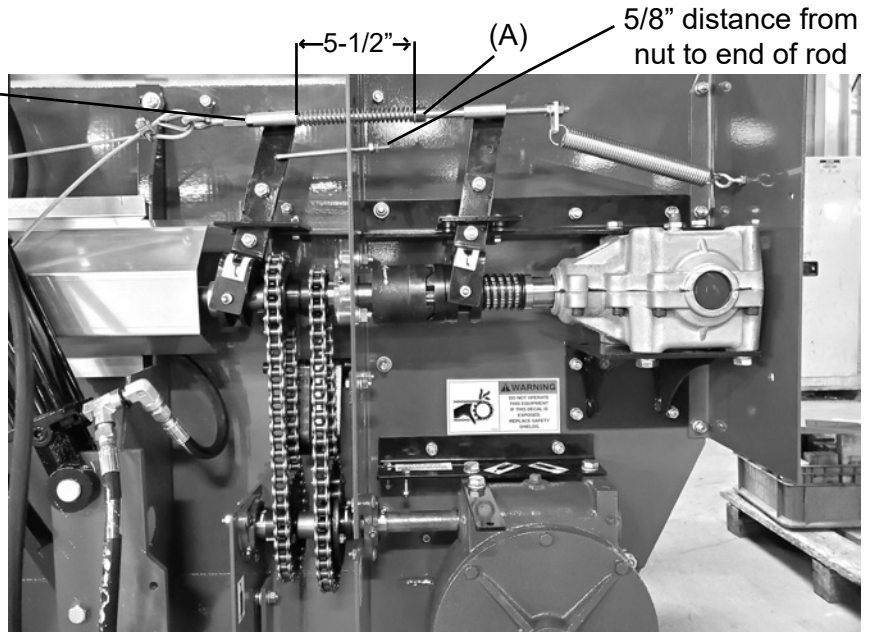

## APRON WORM DRIVE CHAIN

The apron worm drive chains are kept tight with a spring type tightener that does not require adjustment. However, periodic inspection should be made to check for wear.

## BEATER CLUTCH ADJUSTMENT

It may be necessary to compensate for wear in the beater clutch and clutch control yoke. When properly adjusted the moveable jaw clutch should have one-quarter (1/4") inch (distance C) between clutches when disengaged. To adjust, loosen jam nut (A) holding spring bracket. With beater disengaged (clean out position), tighten nut (B) against shifter lever bracket until the proper distance between clutch jaws is reached. Overtightening will cause beater not to fully engage and cause excess tension on cable. Tighten lock nut (D) so there is one thirty-second (1/32") inch clearance between clutch jaws (E).

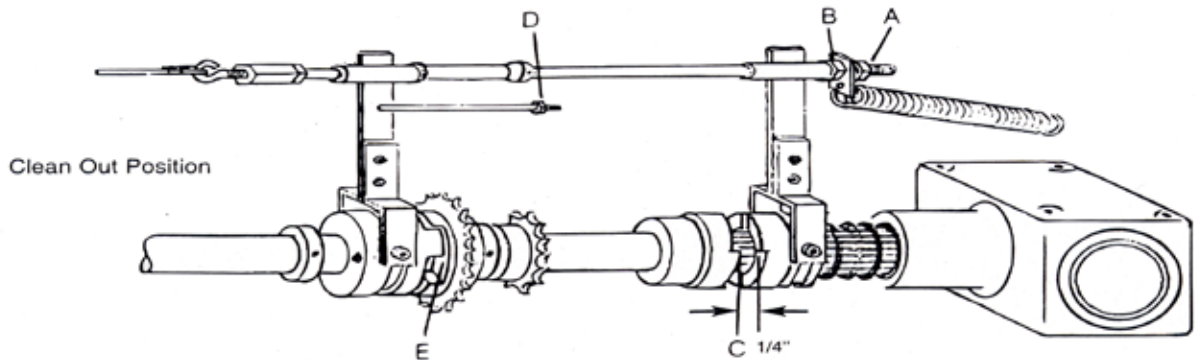

# ADJUSTMENTS

## APRON

1. Adjust the apron by loosening the mounting bolts on the chain slides on the outside of the frame. Mounting bolts shown in the drawing.
2. Tighten the adjusting bolts until the apron chain clears the underside of the axle by 1 inch.
3. Retighten jam nut.

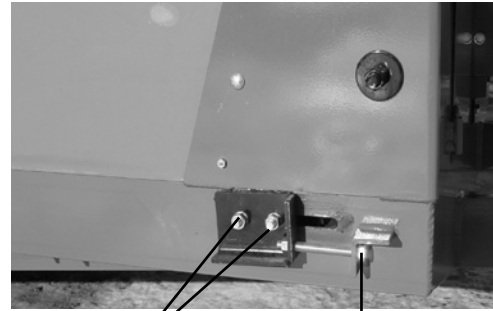

**Mounting Bolts      Adjusting Bolt**

**NOTE:** Tighten the adjusting bolts (on each front corner) equally on each side so that the apron slats run parallel with the ends of the bed. The apron will be damaged if the machine is operated with one end of the apron slats running ahead of the opposite end. Do not tighten the apron chains excessively.

## UPPER BEATER (if applicable)

The upper beater drive chain has a spring-loaded tightener. Tighten the eye bolt to increase the spring tension. Maintain a 1/16" gap between the spring coils for proper tension. If a 1/16" gap between the coils cannot be maintained, a chain link must be removed, or the chain replaced.

**Eye Bolt Adjuster**



# SERVICE

## SHEAR BOLTS - Main Drive

The beater and the apron drive are protected by one shear bolt located on the front end of the side drive shaft (left side of spreader). Two spare shear bolts are provided. Shearing of the bolts is normally due to foreign objects in the manure or **starting the spreader PTO too quickly** with high tractor RPMs. Always use H&S shear bolts when replacing shear bolts.

Shields Removed for Clarity

Spare Shear Bolts

Shear Bolt

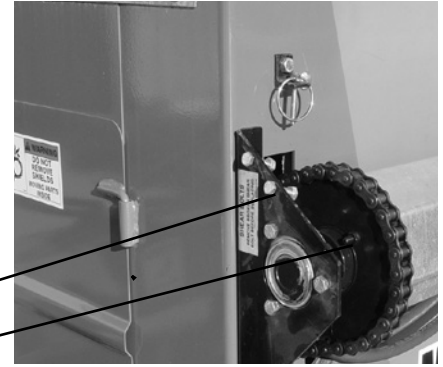

## SHEAR BOLTS - Apron Drive

The worm gearbox and apron are protected by two shear bolts. One on the driven high speed sprocket (A) and one on the low speed sprocket (B). Two spare shear bolts are provided (C). Shearing of these bolts is normally due to the apron being frozen fast to the floor, or catching on frozen "chunks." Occasionally the shear bolts will shear due to the spreader being overloaded. Always determine the cause of failure, and eliminate the cause before replacing the shear bolt, using H&S shear bolts when replacing shear bolts.

**NOTE:** Normal apron speeds at 540 RPM are: low speed 4-1/2 fpm, high speed and clean out position 8-1/2 fpm. If the apron is not moving at these speeds, especially in high or clean out, check and replace the high speed shear bolt (A). **Failure to do so will result in serious damage to the sprocket and shaft.**

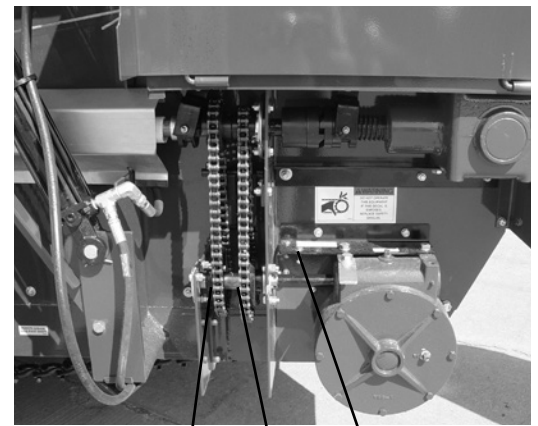

A B C

Shields Removed for Clarity

## BEATER

When replacing beater paddles, the sharp edges of the teeth must lead in the direction of beater travel. On the right half of the beater the teeth must point to the right side of the spreader. On the left half of the beater the teeth must point to the left side of the spreader. Always use H&S special grade 5 bolts, washers, and nuts when replacing. Torque to 60 foot lbs.



(Shown w/optional upper beater for 3231/3237)

## WHEEL BEARING LUBRICATION, CLEAN & RE-PACK INSTRUCTIONS

Wheel hubs are equipped with a grease zerk for regular maintenance. Annually disassemble and clean parts in solvent. Reassemble bearings per instructions in the Service Chapter and tighten the castellated nut on the spindle to the point where there is no end-play and a slight drag on the bearings. Replace the cotter key with a new one of the correct size, bend cotter pin over and reinstall cap.

# OPTIONAL EQUIPMENT

## REAR PAN

The rear pan shown is optional equipment.

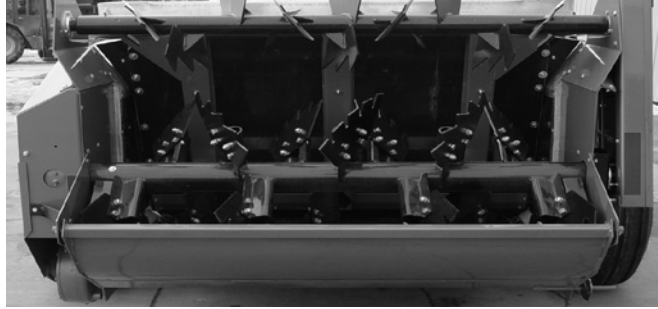

## UPPER BEATER (3231/3237)

An optional upper beater is available and will provide a more uniform spreading in heaped and heavily matted material. The upper beater may be used with hydraulic endgate.



## 2nd HYDRAULIC ENDGATE CYLINDER (3231)

The H&S 3231 manure spreader is equipped with brackets to accept an optional second cylinder to raise and lower the hydraulic endgate. The optional cylinder is located on right hand side of spreader. The kit includes a cylinder, brace, hoses, and connectors to attach to existing cylinder.



**NOTE:** DOUBLE CYLINDER FOR HYDRAULIC ENDGATE IS STANDARD EQUIPMENT ON THE 3237 & 3243.



# **OPTIONAL EQUIPMENT**

## **HYDRAULIC DRIVE**

An optional hydraulic drive unit is available to convert from two speed to variable speed hydraulic drive. Hydraulic drive may be used as a two or four-hose tractor hook-up.



**Front Control Panel**

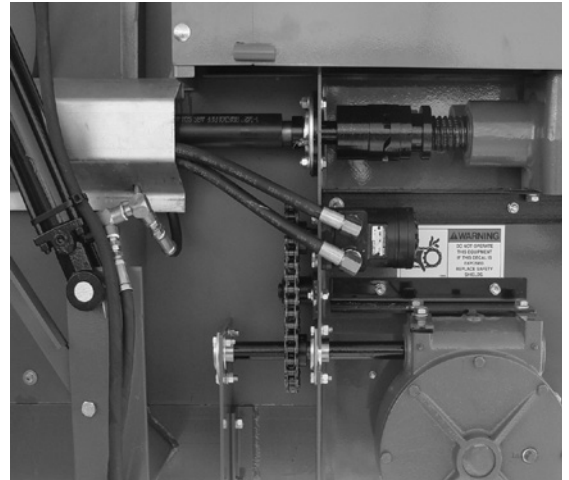

**Hydraulic Motor  
Shields Removed for Clarity**

## **HIGHWAY TRANSPORT LIGHTING**

When transporting on the highway, connect the spreader to the tractor with a lighting power cord. The optional lighting system is to be connected to the 7-pin power receptacle (per SAEJ560B) on your tractor. If your tractor is not equipped with the proper receptacle, see your tractor dealer for details. Make sure lights are functioning properly.

## **SAFETY CHAIN**

Follow state and local regulations regarding use of a safety chain and transport lighting when towing farm equipment on public highways. A proper safety chain should be used to retain the safety connection between the towing and towed machines, in the event of separation of the primary attaching system. Check with local law enforcement agencies for your own particular regulations. Never tow the manure spreader on a public highway at a speed greater than 20 mph (32 kph).

# LUBRICATION

## GENERAL INFORMATION

**IMPORTANT:** *Catch and dispose of fluid per local waste disposal regulations whenever service is performed on hydraulic components, valves, cylinders, hoses, etc.*

## GREASE FITTINGS

There are numerous grease fittings on the spreader. The operator should become familiar with all lubrication points and establish a systematic routine to ensure complete and quick lubrication of the machine. If these are lubricated properly and often enough, it will prolong the life of the spreader. (Grease every 10 hours, **also before and after power washing.**) Make certain that the grease fittings are free of paint and dirt, force a high-quality grease into them until the grease comes out around the shaft on the sleeve-type bearings. On the sealed ball bearings, grease should be added slowly until a slight bead forms at the seals indicating the correct amount of lubricant. Wipe off excess grease to prevent the accumulation of chaff and grit around the bearings.

## DRIVE CHAINS

Lubricate the drive chains with a light machine oil. Keep chains aligned with sprockets, this will lengthen the life of the sprockets and chain. Lubricate chains often.

## GEARBOX

Before using your new machine, check the oil in the main apron drive and beater drive gearbox. Keep the gearbox filled to the oil plug on the side of the main apron gearbox as shown with 80W140 gear lube. The Beater Gearbox is provided with a dipstick to check the level of the 80W90 gear lube. The plug is located on the top of the gearbox alongside the breather plug. Access is gained with an allen wrench.

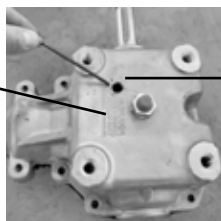
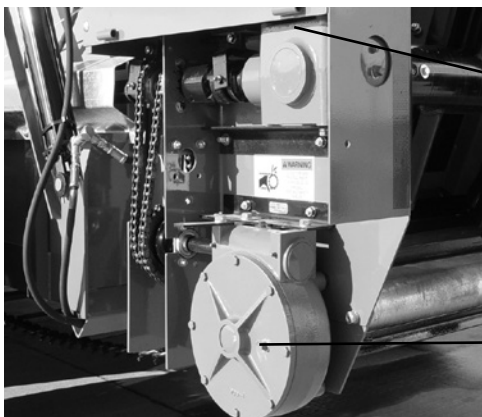

**Beater  
Gearbox  
Oil  
Dipstick**

**Main  
Apron  
Gearbox  
Oil  
Level**

## PTO ASSEMBLY

Keep the male and female shafts of the PTO well-lubricated and free-sliding. Failure to observe this precaution will result in excessive pressure being required to collapse or extend the assembly while subject to operating torque. This excessive force may damage the main shaft bearings. Never lubricate the shield surfaces. The shield surfaces must be kept dry, as dirt accumulation on them will cause the shields to bind and not rotate. Dented or damaged PTO shields, will also result in excessive force being applied against the jackshaft. If at any time the shields do not turn freely, they should be checked to determine the cause, and repaired or cleaned. To avoid damage to the main drive bearings, avoid turning sharp corners while the PTO is running. Start and Stop the PTO slowly to avoid damage to the drive line.

# LUBRICATION

## GREASE ZERK LOCATION - Grease every 10 Hours

- |    |                                   |    |                                   |
|----|-----------------------------------|----|-----------------------------------|
| A. | (3) PTO Shaft                     | I. | (2) Axle Pivot (Model 3231)       |
| B. | (2) Front jack shaft bearings.    | J. | (4) Axle Pivot (Model 3237/3243)  |
| C. | (2) Rear Drive Shaft              | K. | (1) Beater Clutch Control Yoke    |
| D. | (1) Beater                        | L. | (1) Two Speed Clutch Control Yoke |
| E. | (2) Worm Drive Gearbox            | M. | (1) Two Speed Clutch Throwout     |
| F. | (4) Side Shaft (Models 3237/3243) | N. | (1) Rear Support Bearing          |
| G. | (3) Side Shaft (Model 3231)       | O. | (4) Zerks on hubs (1 on each hub) |
| H. | (2) Tailgate Arms                 | P. | (2) Upper Beater                  |

**NOTE:** Shields removed in some pictures for clarity. **DO NOT OPERATE WITH SHIELDS REMOVED.**

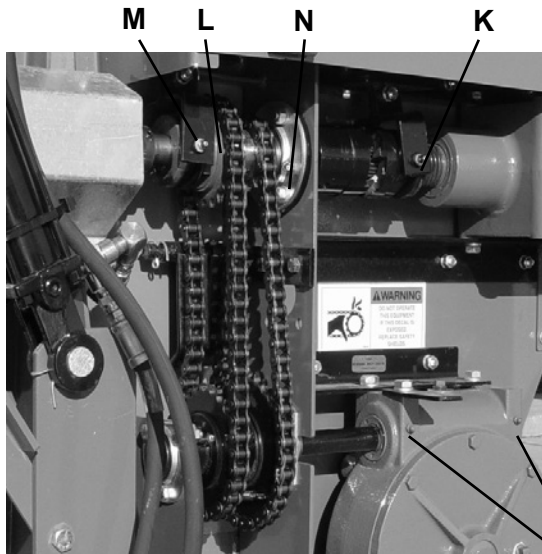

Shields Removed for Clarity

E

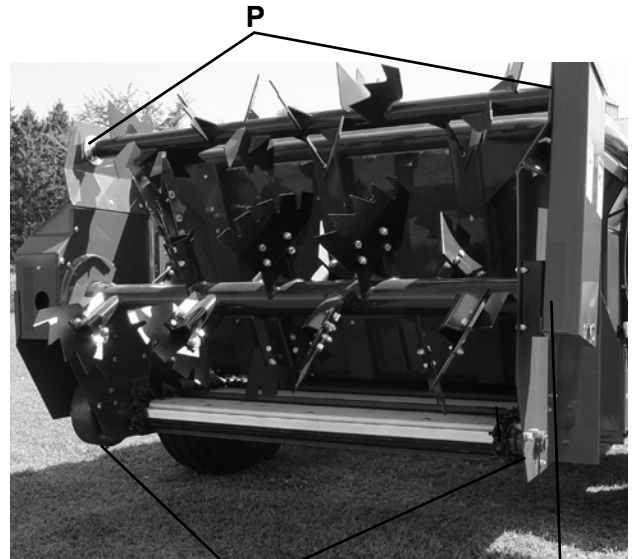

C

D

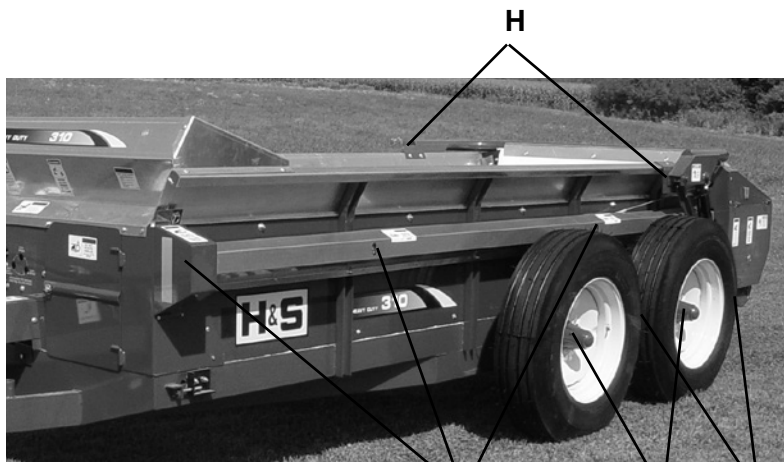

F-G

O

I-J

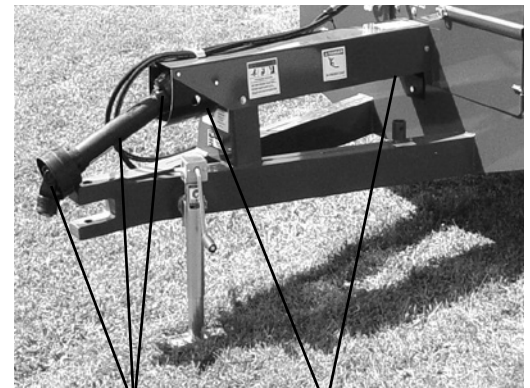

A

B

## WHEEL BEARING LUBRICATION, CLEAN & REPACK INSTRUCTIONS

Wheel hubs are equipped with a grease zerk for regular maintenance. Annually disassemble and clean parts in solvent. Reassemble bearings per instructions in the Service Chapter and tighten the castellated nut on the spindle to the point where there is no end-play and a slight drag on the bearings. Replace the cotter key with a new one of the correct size, bend cotter pin over and reinstall cap.

# DECAL LOCATION

Your H&S Manure Spreader was manufactured with operator safety in mind. Located on the Manure Spreader are various decals to aid in operation, and warn of danger or caution areas. Pay close attention to all decals on your Manure Spreader.



**DO NOT REMOVE ANY OF THESE DECALS. IF THE DECALS ARE LOST, DAMAGED, OR IF THE MANURE SPREADER IS REPAINTED, REPLACE DECALS. REMEMBER: DECALS ARE FOR YOUR PROTECTION AND INFORMATION.**

Listed below are the decals on your Manure Spreader. These decals may be ordered individually by part number or by ordering a complete set.

<u>PART #</u>	<u>QTY</u>	<u>DESCRIPTION</u>
1494A	AR	Warning - Do Not Operate (3 on 3231/3237, 4 on 3243)(1 on Top Beater for 3231/3237)
1494B	2	Warning - Do Not Remove Shields
1494H	1	Danger - Stay Clear - w/Top Beater Only
1494J	AR	Warning - Do Not Clean (2 on 3231/3237, 3 on 3243)(1 on Top Beater for 3231/3237)
1494K	3	Warning - Do Not Remove Shields
1494L	1	Danger - Rotating Driveline
093020	AR	Grease Zerk (15 on 3231, 18 on 3237, 20 on 3243)(2 on Top Beater for 3231/3237)
11599	1	Warning - Stay Clear of Leaks
111593A	3	Danger - Stay Clear of Beater
111593C	2	Warning - Stay Clear of Endgate
12794	2	Warning - Do Not Remove Shields
11211176	2	Shear Bolts
311	1	Patent Number
3187	1	Speed Indicator (Only on if equipped with hydraulic drive)
3494A	2	Remote Grease - Axle Pivot
32222	4	Clear Protector
54033	1	Made in USA 3"
66076	AR	Located Behind Shield (4 on 3231/3237, 5 on 3243)
71188B	1	Jack Storage Position
71188H	1	Beater/Apron Control
71494A	3	Warning Do Not Operate
72203A	1	Warning - Help Avoid Injury
72538	1	Warning - Do Not Operate if Decal is Exposed
82602	1	Warning - Crushing Hazard
9194A	2	Danger - No Step
9194B	1	Danger - Never Allow Riders
93466	1	540 RPM
DCAMB	5	Amber Reflector
DCRED	2	Red Reflectors (1 on Top Beater for 3231/3237)(3 on 3243)
FEMA	1	Fema Decal
84045	1	Since 1967 Decal
86259	2	Model Decal - S3231 Spreader Left/Right
72102	1	Heavy Duty Spreader Decal - S3231 Right
72103	1	Heavy Duty Spreader Decal - S3231 Left
86261	1	Model Decal - S3231 Spreader Front
72097	1	Heavy Duty Spreader Decal - S3231/S3237/S3243 Front
86263	2	Model Decal - S3237 Spreader Left/Right
72108	2	Model Decal - S3243 Spreader Left/Right
72105	1	Heavy Duty Spreader Decal - S3237 Right
72106	1	Heavy Duty Spreader Decal - S3237 Left
86264	1	Model Decal - S3237 Spreader Front
72111	1	Model Decal - S3243 Spreader Front

**Note: AR - As Required**

# DECAL LOCATION

1494K DCAMB 093020 12794 093020 12794 093020



66076 86259(3231) 72103(S3231) 71494A 093020  
86263(3237) 72106(S3237/S3243) UNDER SHIELD

111593A DCAMB



093020 DCRED 3494A

111593C

093020

DCAMB



3494A 1494J 111593A  
1494K 66076  
DCAMB



093020 72102(S3231) 86259(3231) 9194A  
72105(S3237/S3243) 86263(3237)

# DECAL LOCATION

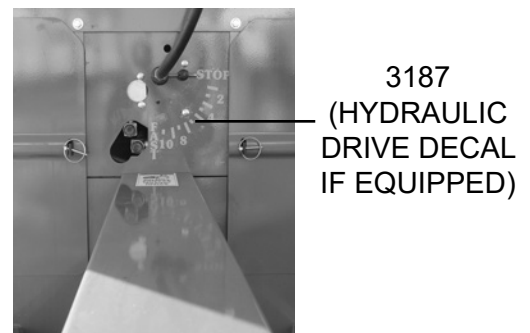
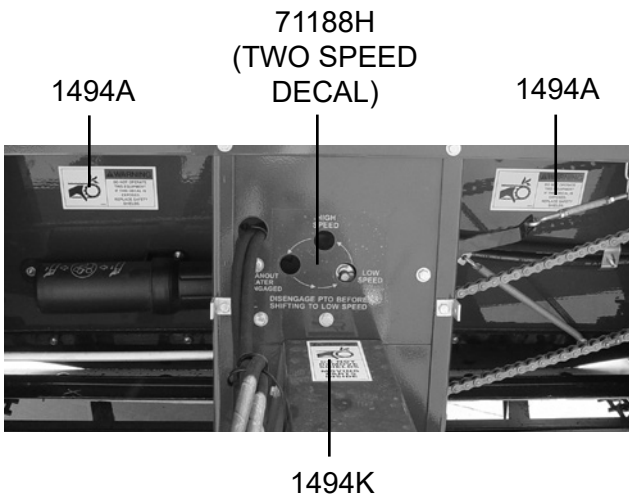
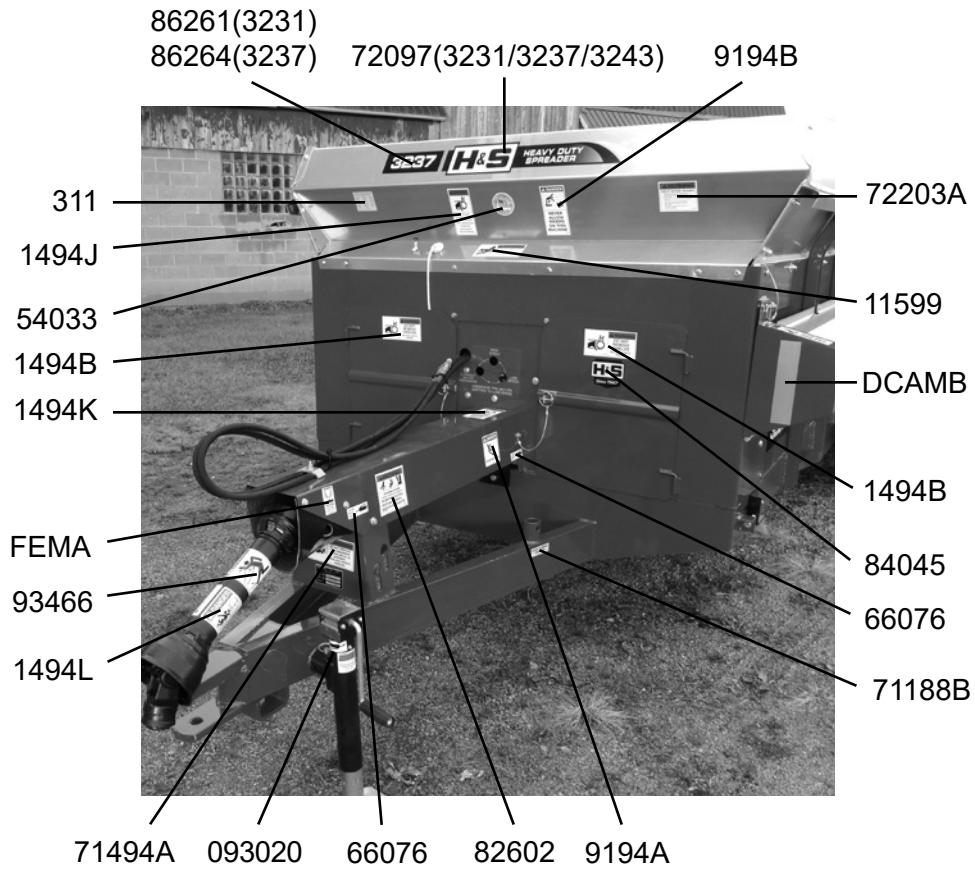

# DECAL LOCATION

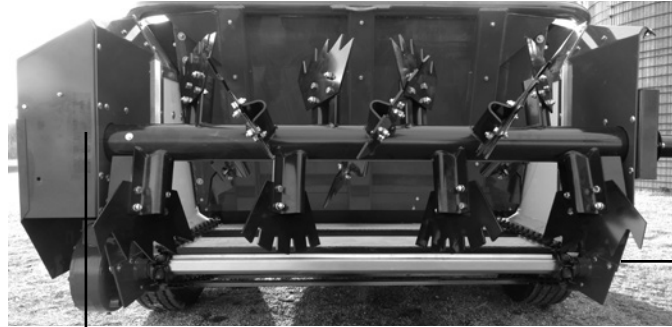

DCRED

DCRED



72538

11211176

093020

11211176

093020

093020

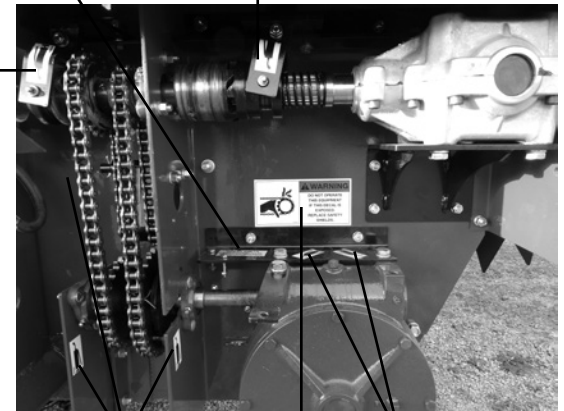

093020

1494A

093020



1494H

111593A

1494J

DCAMB

DCRED

111593A

093020

66076



093020

1494A  
(UNDER  
SHIELD)

093020

# TROUBLESHOOTING



**WARNING:**  
**MAKE SURE THAT THE TRACTOR IS SHUT OFF AND THE SPREADER CANNOT MOVE BEFORE SERVICING THE MANURE SPREADER. MAINTENANCE AND REPAIR SERVICE WORK TO BE PERFORMED BY A QUALIFIED SERVICE PERSON ONLY.**

<b>TROUBLE...</b>	<b>POSSIBLE CAUSE...</b>	<b>POSSIBLE REMEDY...</b>
Beater Does Not Turn	PTO Not Turning	Engage Tractor PTO
	Beater Not Engaged	Engage Beater
	Main Drive Shear Bolt Sheared	Replace Main Drive Shear Bolt
	Front Drive Chain Off, Broken, or Missing	Replace or Repair Front Drive Chain
	Control Cable out of Adjustment	Adjust Control Cable
	Splined Beater Insert Worn or Splines Sheared Off	Replace Splined Beater Insert and Gearbox Output Shaft
Beater Will Not Disengage	Control Cable Out of Adjustment	Adjust Control Cable
	Control Linkage Binding	Check Control Linkage, Make Sure It Is Free Moving
Apron Does Not Turn	PTO Not Turning	Engage Tractor PTO
	Main Drive Shear Bolt Sheared	Replace Main Drive Shear Bolt
	Front Drive Chain Off, Broken, or Missing	Replace or Repair Front Drive Chain
Apron Only Drives In Low	High Speed Shear Bolt Sheared or Missing	Replace Sheared or Missing Shear Bolt
Apron only Drives in High	Low Speed Shear Bolt Sheared or Missing	Replace Sheared or Missing Shear Bolt
	Dog or Dog Spring Worn, Broken or Missing	Replace Worn, Broken or Missing Dog or Dog Spring
	Shear Plate Worn	Replace Shear Plate









# **H&S MFG. CO.**

products approved

for the

## **FEMA**

# **SEAL OF QUALITY**



Manufactured by:

**H&S MANUFACTURING CO., INC.**

2608 S. HUME AVE. MARSHFIELD, WI 54449

(715) 387-3414 | [hsmfco.com](http://hsmfco.com)

