

# H&S

*TWIN-FLEX*  
MERGER

## 6128

# OPERATOR'S MANUAL



## WARNING

**READ AND UNDERSTAND THIS MANUAL  
BEFORE OPERATING THIS EQUIPMENT.  
UNSAFE OPERATION OR MAINTENANCE OF  
THIS EQUIPMENT CAN RESULT IN SERIOUS  
INJURY OR DEATH.**

Revision #02  
Starting Serial #021TF62828

HSMFG001120

Part #79760

## H&S MANUFACTURING CO., INC.

MARSHFIELD, WISCONSIN 54449

(715) 387-3414 - FAX (715) 384-5463 - [hsmfgco.com](http://hsmfgco.com)

# **CONTENTS**

Warranty . . . . .	1
Manufacturer's Statement . . . . .	2
Warranty Registration Form . . . . .	3
Dealer Pre-Delivery Checklist . . . . .	5
Dealer Delivery Checklist . . . . .	7
Be Alert Symbol . . . . .	9
Explanation of Safety Signs . . . . .	10
Safety Decals . . . . .	11-12
Warning - Owner Must Read and Understand . . . . .	13
Cap Screw Torque Values . . . . .	14
Hydraulic Fitting Torque Specifications . . . . .	15-16
Set-Up & Assembly . . . . .	17-18
Transporting . . . . .	19
Machine Prep & Operation . . . . .	20-23
Adjustments . . . . .	24-26
Service . . . . .	27-29
Optional Equipment . . . . .	30
Lubrication Guide . . . . .	31
Decal Location & Identification . . . . .	32-40
Service Notes . . . . .	41-42

## H&S WARRANTY

H&S Manufacturing Co., Inc. ("H&S") warrants this product to be free from defect in material and workmanship. Except as noted below, this warranty term is twelve (12) months on labor, and twenty-four (24) months on parts from the date of delivery of the product to the original purchaser by an authorized H&S dealer. Under this warranty, H&S will repair or replace, at its option, any covered part which is found to be defective in material or workmanship during the applicable warranty term. In no case will the covered repair cost of a part or parts exceed the replacement cost of that part. Warranty service must be performed by H&S or a dealer authorized by H&S to sell and/or service the product involved, which will use only new or remanufactured parts or components furnished by H&S. This warranty includes approved parts and labor to fix the product but does not include, and the purchaser is responsible for, any service call and/or transportation of the product to and from the dealer's place of business, for any premium charged for overtime labor requested by the purchaser, and for any service work not directly related to any defect covered under this warranty. This warranty includes only those components of the product manufactured by H&S. Warranty for any component not manufactured by H&S including, but not limited to, engines, batteries, tires, rims, hydraulic motors, pumps, etc. are covered by the warranty, if any, provided separately by their respective manufacturers.

This warranty in all its parts, is extended solely to the original purchaser of the product, is terminated upon any subsequent transfer or sale from or by the original purchaser and extends no third party benefits or rights whatsoever.

The warranty term for any product used in any commercial, custom, for hire or rental application, is limited to six (6) months from the date of delivery of the product to the original purchaser or the first day of service, whichever comes first, by an authorized H&S dealer.

For commercial, custom for hire, or rental application, warranty is limited to 6 months from the date of delivery to the original purchaser, or the first day in service, whichever is earlier.

This warranty does not include: (1) Any product that has been altered or modified in ways not approved by H&S; (2) Depreciation or damage caused by normal wear, use for which the product was not designed, misuse, improper or insufficient maintenance, improper operation, accident or failure to follow the product Operator's Manual recommendations and product decal recommendations; (3) Normal maintenance parts and service; (4) Repairs made with parts other than those available from H&S or performed by anyone other than H&S or a dealer authorized by H&S to sell and/or service the product involved.

To secure warranty service the purchaser must report the product defect to a dealer authorized by H&S to sell and/or service the product involved within the applicable warranty term together with evidence of the warranty start date and make the product available to that dealer within a reasonable period of time.

**THERE ARE NO WARRANTIES WHICH EXTEND BEYOND THE DESCRIPTION ON THE FACE OF THIS WARRANTY.** H&S and the companies affiliated with it makes no warranties, representations, or promises, express or implied, as to the performance or freedom from defect of its products other than those set forth above and **NO IMPLIED WARRANTY OF MERCHANTABILITY, FITNESS OR FITNESS FOR A PARTICULAR PURPOSE IS MADE. IN NO EVENT WILL THE DEALER, H&S OR ANY COMPANY AFFILIATED WITH H&S BE LIABLE FOR INCIDENTAL OR CONSEQUENTIAL DAMAGES.** The **ONLY REMEDY** the purchaser has in connection with the breach of performance of any warranty on H&S products are those set forth above.

The selling dealer has no authority to make any representation or promise on behalf of H&S, or to modify the terms or limitations of this warranty in any way.

11/14/18

## **MANUFACTURER'S STATEMENT**

Your New H&S Product has been manufactured of the finest quality materials and components. The performance you get from your machine is largely dependent upon how well you read and understand this manual and apply this knowledge. There is a right and a wrong way to do everything. Please do not assume that you know how to operate and maintain your Machine before reading this manual carefully. Keep this manual available for ready reference.

H&S reserves the right to make changes or add improvements to its products at any time without incurring any obligation to make such changes to products previously manufactured. Specifications, statements and descriptions of Products contained in this publication are subject to change without prior notification.

# WARRANTY REGISTRATION

- ❖ Date of Purchase: \_\_\_\_\_
  - ❖ Purchaser Name: \_\_\_\_\_
  - ❖ Street Address: \_\_\_\_\_
  - ❖ City: \_\_\_\_\_
  - ❖ State: \_\_\_\_\_ Zip: \_\_\_\_\_
  - ❖ Phone Number: \_\_\_\_\_
  - E-mail Address: \_\_\_\_\_
  - ❖ Product: \_\_\_\_\_
  - ❖ Model Number: \_\_\_\_\_
  - ❖ Serial Number: \_\_\_\_\_
  - ❖ You have received the Operators Manual for this product. Yes \_\_\_\_\_ No \_\_\_\_\_
  - Interested in receiving the H&S Newsletter? Yes \_\_\_\_\_ No \_\_\_\_\_
- 

- ❖ Dealer Name: \_\_\_\_\_
- ❖ Street Address: \_\_\_\_\_
- ❖ City: \_\_\_\_\_
- ❖ State: \_\_\_\_\_ Zip: \_\_\_\_\_
- ❖ Signature: \_\_\_\_\_

❖ *All fields must be filled out to insure prompt notification of product and/or warranty updates.*

Please mail the completed WARRANTY REGISTRATION FORM to:  
H&S Manufacturing Co., Inc.  
2608 S. Hume Ave.  
Marshfield, WI 54449

**Intentionally Left Blank**

# DEALER PRE-DELIVERY CHECK LIST

## AFTER COMPLETION, DEALER SHOULD REMOVE AND RETAIN FOR RECORDS

After the Merger has been completely set-up, check to be certain it is in correct operating order before delivering to the customer. The following is a list of points to inspect. Check off each item as you have made the proper adjustments and found the item operating satisfactorily.

- Merger was not damaged in shipment. Check for dents and loose or missing parts. Report damage immediately to H&S Manufacturing Co., Inc.
- Merger has been correctly assembled according to instructions in this manual. Wheel nuts and all other fasteners are tightly secured.
- All bolts and fasteners are tight.
- All grease fittings have been lubricated. See LUBRICATION section of this manual for details.
- Hoses and fittings are properly attached and there are no visible leaks.
- All belts are at proper tension.
- PTO Shields turn freely.
- All shields and guards are in place and fastened.
- All mechanisms are operating trouble free.
- Tires are inflated to correct pressure.
- Decals are in place and legible.

Model Number \_\_\_\_\_

Serial Number \_\_\_\_\_

Dealer's Name \_\_\_\_\_

Inspection Date \_\_\_\_\_

Signature of Pre-Delivery Inspector \_\_\_\_\_

(Remove Dealers File Copy At Perforation)

**Intentionally Left Blank**



# DEALER DELIVERY CHECK LIST

## AFTER COMPLETION, DEALER SHOULD REMOVE AND RETAIN FOR RECORDS

This check list that follows is an important reminder of valuable information that should be passed on to the customer at the time this Merger is delivered.

Check off each item as you explain it to the customer.

This delivery check list, when properly filled out and signed assures the customer that the Pre-delivery service was satisfactorily performed.

- Explain to the customer that the pre-delivery inspection was made.
- Explain to the customer all the safety precautions they must exercise when operating this unit.
- Explain to the customer the operation and adjustments of the Merger.
- Explain to customer that regular lubrication is required for proper operation and long life of the machine.
- Show the customer the LUBRICATION section of Operator's Manual.
- Give the customer Operator's Manual and make sure they read and understand all operating and service instructions.
- Have the customer sign a completed "Warranty Registration", and mail it.

Date Delivered \_\_\_\_\_

Dealer's Name \_\_\_\_\_

By \_\_\_\_\_

Signature of Original Buyer \_\_\_\_\_

Note: Warranty is not valid until warranty card is completed and returned to H&S Mfg. Co., Inc.

**Intentionally Left Blank**

## SAFETY INFORMATION



**BE  
ALERT!**

**YOUR SAFETY  
IS INVOLVED.**

THIS SYMBOL IS USED THROUGHOUT THIS BOOK WHENEVER YOUR PERSONAL SAFETY IS INVOLVED. TAKE TIME TO BE CAREFUL. REMEMBER: THE CAREFUL OPERATOR IS THE BEST OPERATOR. MOST ACCIDENTS ARE CAUSED BY HUMAN ERROR. CERTAIN PRECAUTIONS MUST BE OBSERVED TO PREVENT THE POSSIBILITY OF INJURY OR DAMAGE.

**H&S MANUFACTURING CO., INC.**

# SAFETY INFORMATION

## RECOGNIZE SAFETY INFORMATION

This is the safety-alert symbol. When you see this symbol on your machine or in this manual, be alert to the potential for personal injury.

Follow recommended precautions and safe operating practices.



## UNDERSTAND SIGNAL WORDS

A single word; DANGER, WARNING, or CAUTION - is used with the safety-alert symbol. DANGER identifies the most serious hazards.

Safety signs with signal word DANGER or WARNING are typically near specific hazards.

General precautions are listed on CAUTION safety signs.



WARNING



CAUTION



## FOLLOW SAFETY INSTRUCTIONS

Carefully read all safety messages in this manual, and all safety signs on your machine. Follow all recommended precautions and safe operating procedures.

Keep signs in good condition. Immediately replace any missing or damaged signs.

## OBSERVE MAXIMUM TRANSPORT SPEED

**The maximum transport speed for this implement is 32 km/h (20 m.p.h.).**

Some tractors are capable of operating at speeds that exceed the maximum transport speed of this implement. Regardless of the maximum speed capability of the tractor being used to tow this implement, do not exceed the implement's maximum transport speed.

Exceeding the implements maximum transport speed can result in:

- \* Loss of control of the tractor/implement combination
- \* Reduced or no ability to stop during braking
- \* Implement tire failure
- \* Damage to the implement structure or its components

Use additional caution and reduce speed when towing under adverse surface conditions, when turning, and when on inclines.

Do not attempt transport if the fully loaded implement weighs more than 1.5 times the weight of the tractor.



# SAFETY INFORMATION

**⚠ WARNING**

**HELP AVOID INJURY**

- READ & UNDERSTAND THE OPERATOR'S MANUAL PROVIDED WITH THIS MACHINE. IF MISPLACED CALL H & D MANUFACTURING AT 715-387-3414 WITH MODEL AND SERIAL NUMBER.
- UNDERSTAND ALL SAFETY WARNINGS AND FUNCTION OF CONTROLS.
- KEEP SAFETY DEVICES IN PLACE AND WORKING.
- KEEP YOURSELF AND OTHERS WELL CLEAR OF MOVING PARTS.
- DISCONNECT ALL POWER BEFORE SERVICING OR CLEANING THE MACHINE.
- DO NOT EXCEED 50 MPH.

72203A



**⚠ WARNING**

**DO NOT GO NEAR LEAKS**

- High pressure oil easily punctures skin causing serious injury, gangrene or death.
- If injured, seek emergency medical help. Immediate surgery is required to remove oil.
- Do not use finger or skin to check for leaks.
- Lower load or relieve hydraulic pressure before loosening fittings.

11395

**⚠ DANGER**



**NEVER ALLOW RIDERS ON THIS MACHINE**

82001



**⚠ WARNING**

**STAY CLEAR**

CONTACT WITH TINES MAY CAUSE SERIOUS INJURY. DISENGAGE ALL POWER AND SHUT OFF TRACTOR BEFORE CLEANING OR SERVICING MERGER.

UC82211A



**⚠ DANGER**

**STAY CLEAR OF MOVING PARTS**

FAILURE TO HEED THIS WARNING MAY RESULT IN PERSONAL INJURY OR DEATH.

KEEP CLOTHING, YOURSELF AND OTHERS WELL CLEAR.

3300A

**⚠ DANGER**



**STAY CLEAR OF MOVING PARTS**

FAILURE TO HEED THIS WARNING MAY RESULT IN PERSONAL INJURY OR DEATH.

KEEP CLOTHING, YOURSELF AND OTHERS WELL CLEAR.

73101

**⚠ DANGER**



**STAY CLEAR OF MERGER WHEN OPENING OR CLOSING.**

FAILURE TO HEED THIS WARNING MAY RESULT IN PERSONAL INJURY OR DEATH.

KEEP CLOTHING, YOURSELF AND OTHERS WELL CLEAR.

31401

**⚠ DANGER**



**MAINTAIN SAFE CLEARANCE FROM ELECTRICAL POWER LINES AND AVOID CONTACT WITH ANY ELECTRICALLY CHARGED CONDUCTOR.**

CONTACT WITH ELECTRIC POWER SOURCES CAN RESULT IN ELECTRICAL SHOCK OR ELECTROCUTION.

FAILURE TO HEED THIS WARNING MAY RESULT IN SERIOUS INJURY OR DEATH.

1484P

# SAFETY INFORMATION

**⚠ DANGER**



**ROTATING DRIVELINE CONTACT CAN CAUSE DEATH  
KEEP AWAY!**

DO NOT OPERATE WITHOUT:

- ALL DRIVELINE, TRACTOR AND EQUIPMENT SHIELDS IN PLACE.
- DRIVELINES SECURELY ATTACHED AT BOTH ENDS.
- DRIVELINE SHIELDS THAT TURN FREELY ON DRIVELINE.

1434L



**⚠ WARNING**

SLAG GENERATED BY HEATING OR CUTTING NEAR PRESSURIZED FLUID LINES CAN PUNCTURE LINES RESULTING IN SEVERE INJURY. NEVER WELD OR CUT ON HYDRAULIC RESERVOIR OR FRAMEWORK USED AS A RESERVOIR.

01327118



**⚠ DANGER**

**STAY CLEAR OF EXTENSION WHEN RAISING OR LOWERING**

12502A

**⚠ WARNING**



**CRUSHING HAZARD**

TO PREVENT SERIOUS INJURY OR DEATH:

KEEP HANDS AND BODY OUT OF HITCH AREA WHEN ATTACHING TOWING VEHICLE.

KEEP BODY CLEAR OF CRUSH POINT BETWEEN TOWING VEHICLE AND LOAD.

KEEP FEET AND LEGS CLEAR FROM UNDER TONGUE AREA IN CASE OF POSSIBLE JACK FAILURE.

4286C

**⚠ DANGER**



**ROTATING DRIVELINE CONTACT CAN CAUSE DEATH**

5896B

**⚠ WARNING**



**STAY CLEAR**

1906C



**⚠ WARNING**

HYDRAULIC SYSTEM ON MERGER CONTAINS STORED ENERGY. RELEASING PRESSURE FROM THE ACCUMULATOR BY ANY MEANS (WELDING, TORCH, LOOSE FITTINGS) MAY RESULT IN THE RAPID RELEASE OF OIL AND/OR GAS CAUSING PERSONAL INJURY OR DEATH.

0238118

# SAFETY INFORMATION

## TRACTOR:

This operators manual uses the term “Tractor” when identifying the the power source.



# W A R N I N G

## TO PREVENT SERIOUS INJURY OR DEATH

BEFORE YOU ATTEMPT TO OPERATE THIS EQUIPMENT, READ AND STUDY THE FOLLOWING INFORMATION. IN ADDITION, MAKE SURE THAT EVERY INDIVIDUAL WHO OPERATES OR WORKS WITH THIS EQUIPMENT, WHETHER FAMILY MEMBER OR EMPLOYEE, IS FAMILIAR WITH THESE SAFETY PRECAUTIONS.

**DO NOT ALLOW PERSONNEL OTHER THAN THE QUALIFIED OPERATOR NEAR THE MACHINE.**

KNOW HOW TO STOP MACHINE BEFORE STARTING IT.

**BEFORE** starting tractor, be sure PTO shields turn freely and PTO is securely locked to tractor.

Stop the tractor engine, remove ignition key and allow all mechanisms to stop before cleaning or working on the machine.

If the machine becomes clogged or requires servicing, disengage the tractor PTO or tractor hydraulics.

**DO NOT** attempt to perform maintenance or repair with tractor running and PTO or tractor hydraulics hooked up.

**DO NOT** step up on machine at any time.

**NEVER** manually feed material into the pickup.

**DO NOT** allow minors to operate or be near the machine.

**DO NOT** clean, adjust, or lubricate the machine when any part is in operation.

**STAY CLEAR** of machine when rasing and lowering machine and during folding and unfolding machine.

**KEEP** hands, feet, and clothing away from pickup conveyor belts WHEN THEY ARE IN MOTION.

**LOOSE** and floppy clothing should not be worn by the operator.

**BE SURE** the machine is clear of people tools, and other objects before engaging PTO or tractor hydraulics.

**STAY CLEAR** of hydraulic lines and fittings. They may be under extreme pressure or heat.

**NEVER** start the Merger until all guards and safety shields are in place.

**CAUTION** - Beware of low electrical wires.

H&S Manufacturing Co. always takes the operator and their safety into consideration and guards exposed moving parts for their protection. However, some areas cannot be guarded or shielded in order to assure proper operation. In addition, the operators manual and decals on the machine itself warn you of further danger and should be read and observed closely.

**Study The Above Safety Rules**

**ATTENTION - BE ALERT - YOUR SAFETY IS INVOLVED**

# CAP SCREW TORQUE VALUES

The specifications below are the torque values for fasteners as it adheres to the SAE torque value standards. All fasteners should be torqued to the proper values found in the figures below unless otherwise specified by the engineering drawing.

Lubed torque would be any fastener that has grease, liquid Loctite, oil, etc. on the threads.

Dry torque would be any fastener which has threads that are clean and dry and do not have any liquid Loctite or grease on them.

## Hex Head Fasteners

The figure shown below shows how to determine what grade a fastener is.

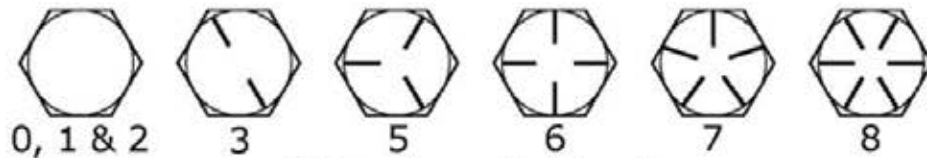

SAE grades on bolt heads

SUGGESTED ASSEMBLY TORQUE VALUES							WORKING TORQUE			
Diam & Thrds Per Inch	SAE GRADE 2 -6"		SAE GRADE 5		SAE GRADE 8		18-8 SS	316 SS	BRASS	SILICON BRONZE
	Dry FT. LB.	LUB FT. LB.	Dry FT. LB.	LUB FT. LB.	Dry FT.LB.	LUB FT. LB.	IN LBS	IN LBS	IN LBS	IN LBS
1/4-20	5.5	4.2	8	6.3	12	9	75.2	78.8	61.5	68.6
1/4-28	6.3	4.7	10	7.2	14	10	94.0	99.0	77.0	87.0
5/16-18	11	8	17	13	24	18	132	138	107	123
5/16-24	12	9	19	14	27	20	142	147	116	131
3/8-16	20	15	30	23	45	35	236	247	192	219
3/8-24	23	17	35	25	50	35	259	271	212	240
7/16-14	32	24	50	35	70	50	376	393	317	349
7/16-20	36	27	55	40	80	60	400	418	327	371
1/2-13	50	35	75	55	110	80	517	542	422	480
1/2-20	55	40	85	65	120	90	541	565	443	502
9/16-12	70	55	110	80	150	110	682	713	558	632
9/16-18	80	60	120	90	170	130	752	787	615	697
5/8-11	100	75	150	110	210	160	1110	1160	907	1030
5/8-18	110	85	170	130	240	180	1244	1301	1016	1154
3/4-10	175	130	260	200	380	280	1530	1582	1249	1416
3/4-16	200	140	300	220	420	310	1490	1558	1220	1382
7/8-9	170	125	430	320	600	450	2328	2430	1905	2140
7/8-14	180	140	470	350	670	500	2318	2420	1895	2130
1-8	250	190	640	480	910	680	3440	3595	2815	3185
1-14	280	210	720	540	1020	760	3110	3250	2545	2885



# HYDRAULIC FITTING TORQUE SPECIFICATIONS

Tapered Pipe Thread Size - Assembly turns from Finger Tight (TFFT) for Tapered Threads		TFFT
BSPT (Uncommon)	NPTF (Common)	
1/8-28	1/8-27	2 - 3
1/4-19	1/4-18	2 - 3
3/8-19	3/8-18	2 - 3
1/2-14	1/2-14	2 - 3
3/4-14	3/4-14	2 - 3
1-11	1-11 1/2	1.5 - 2.5
1 1/4-11	1 1/4-11 1/2	1.5 - 2.5
1 1/2-11	1 1/2-11 1/2	1.5 - 2.5
2-11	2-11 1/2	1.5 - 2.5



ORB - SAE J1926 Straight Thread Port Assembly Torques													
		Assembly Torque (+10% -0) **If fitting is being torqued into aluminum or brass, subtract 35% from standard torque value**											
		Non-Adjustable				Adjustable				Plugs			
		ORFS		JIC NPT		ORFS		JIC		Hollow Hex		Hex Head	
Dash Size	SAE Size (UN/UNF)	Ft. lbs. (In. lbs.)	Into Alum. Or Brass Ft. lbs. (in. lbs.)	Ft. lbs. (In. lbs.)	Into Alum. Or Brass Ft. lbs. (in. lbs.)	Ft. lbs. (In. lbs.)	Into Alum. Or Brass Ft. lbs. (in. lbs.)	Ft. lbs. (In. lbs.)	Into Alum. Or Brass Ft. lbs. (in. lbs.)	Ft. lbs. (In. lbs.)	Into Alum. Or Brass Ft. lbs. (in. lbs.)	Ft. lbs. (In. lbs.)	Into Alum. Or Brass Ft. lbs. (in. lbs.)
2	5/16-24	-	-	(85)	(55)	-	-	(80)	(39)	(30)	(19.5)	(85)	(55)
3	3/8-24	-	-	(155)	(101)	-	-	(100)	(65)	(55)	(36)	(155)	(101)
4	7/16-20	(310)	(201.5)	(260)	(169)	(180)	(117)	(180)	(117)	(120)	(78)	(260)	(169)
5	1/2-20	(360)	(234)	(280)	(182)	(360)	(234)	(250)	(162.5)	(170)	(110.5)	(280)	(182)
6	9/16-18	(420)	(283)	(350)	(227.5)	(420)	(273)	(350)	(227.5)	(410)	(266.5)	(350)	(175)
8	5/8-16	60	39	(620)	(403)	60	39	(620)	(217)	60	39	(620)	(403)
10	7/8-14	100	85	85	55	100	85	85	55.25	100	85	85	55
12	1 1/16-12	135	88	135	88	135	88	135	88	135	88	135	88
14	1 3/16-12	175	114	175	114	175	114	175	114	175	114	175	114
16	1 5/16-12	200	130	200	130	200	130	200	130	200	130	200	130
20	1 5/8-12	250	162.5	250	162.5	250	162.5	250	162.5	250	162.5	250	162.5
24	1 7/8-12	305	198	305	198	305	198	305	198	305	198	305	198
32	2 1/2-12	375	244	375	244	375	244	375	244	375	244	375	244

# HYDRAULIC FITTING TORQUE SPECIFICATIONS

## Code 61 and 62 Flange Recommended Bolt Torques

### Steps to Properly Assemble the Flange Port Clamping Bolts:

1. Inspect components to ensure that male and female port threads and sealing surfaces are free of burrs, nicks and scratches, or any foreign material.
2. Lubricate the O-ring
3. Position flange and clamp halves
4. Place lock washers on bolts and insert through clamp halves
5. Hand tighten bolts.
6. Torque bolts in diagonal sequence in small increments to the appropriate torque level \*\*refer to the table below.

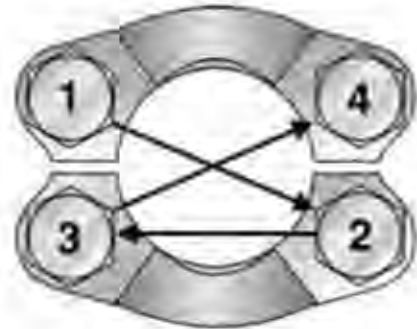

*Flange Bolt Tightening Sequence*

Code 61						Code 62					
Dash Size	Flange Size	Inch Bolt (SAE J518)	Torque ft. lbs.	Metric Bolt (ISO 6162)	Torque N-m	Dash Size	Flange Size	Inch Bolt (SAE J518)	Torque ft. lbs.	Metric Bolt (ISO 6162)	Torque N-m
8	1/2	5/16-18	17 ± 2	M8	24	8	1/2	5/16-18	17 ± 2	M8	24
12	3/4	3/8-16	31	M10	50	12	3/4	3/8-16	31	M10	50
16	1	3/8-16	31 ± 4.5	M10	50	16	1	7/16-14	52	M12	92
20	1-1/4	7/16-14	52	M12	92	20	1-1/4	1/2-13	77	M14	130
24	1-1/2	1/2-13	77	M12	92	24	1-1/2	5/8-11	155	M16	210
32	2	1/2-13	77	M12	92	32	2	3/4-10	265	M20	400
40	2-1/2	1/2-13	77	M12	92						
48	3	5/8-11	155	M16	210						
56	3-1/2	5/8-11	155	M16	210						
64	4	5/8-11	155	M16	210						
80	5	5/8-11	155	M16	210						



### 37° Flare (JIC) Assembly Torques and FFWR

SAE Dash Size	Thread Size	Assembly Torque (+10%-0)		Tube Connection FFWR	Swivel Nut or Hose Connection FFWR
		In. lb.	ft. lb.		
-2	5/16-24	35	3	-	-
-3	3/8-24	65	5	-	-
-4	7/16-20	155	13	2 1/2	2
-5	1/2-20	165	14	2	2
-6	9/16-18	265	22	2	1 1/2
-8	5/8-16	505	42	2	1 1/2
-10	7/8-14	720	60	1 1/2	1 1/2
-12	1 1/16-12	1000	84	1 1/2	1 1/4
-14	1 3/16-12	1200	100	1 1/2	1 1/4
-16	1 5/16-12	1415	118	1 1/2	1
-20	1 5/8-12	2015	168	1	1
-24	1 7/8-12	2340	195	1	1
-32	2 1/2-12	3180	265	1	1
-40	3-12	-	-	1	1

## **SET-UP & ASSEMBLY**

**NOTE:** Determine right or left side of the Merger by viewing it from the rear. If instructions or parts lists call for hardened bolts, refer to bolt torque chart.

- Check the Merger for proper assembly and adjustment. Make sure that all bolts are tightened. Securely retighten after a few hours of operation as bolts can loosen up on new machinery.
- If the merger was shipped w/o the rims/tire assemblies attached, Attach the rims/tire assemblies, using the lug nuts furnished. Torque the mounting hardware to correct torque specification. Check the wheel bolts periodically thereafter.
- Check tires and inflate to the recommended pressure. (15R19 x19.5 Radial Tires = 70 PSI)
- Lubricate the Merger completely (Refer to the Lubrication section in this Manual).

# SET-UP & ASSEMBLY

## IMPORTANT! HEAD SET-UP FROM SHIPPING

- \* Connect the tractor to the merger using the instructions from the Machine Prep & Operation Chapter in this Manual.
- Loosen the (4) head bolts (A) with 3/4" wrenches on both sides of the locking brackets - **total of (8) on each head**. **NOTE: Access to the head nuts is gained through the opening on the back of each head (C) as shown in the bottom picture.**
- Connect the hydraulics lines to the tractor.
- Using the tractor hydraulics, lower the heads to the ground.



- There is a 3/8" shim that is included in the wiring/control box. Insert the 3/8" shim from the **BOTTOM** of the locking bracket on the suspension linkage between the split - (B). **NOTE: The split will open after the heads have been lowered to the ground.**
- With the shim in place, tighten all (8) head bolts back up checking to make sure the 3/8" gap is maintained as the bolts are tightened.
- Remove the shim and repeat the process on the other head.

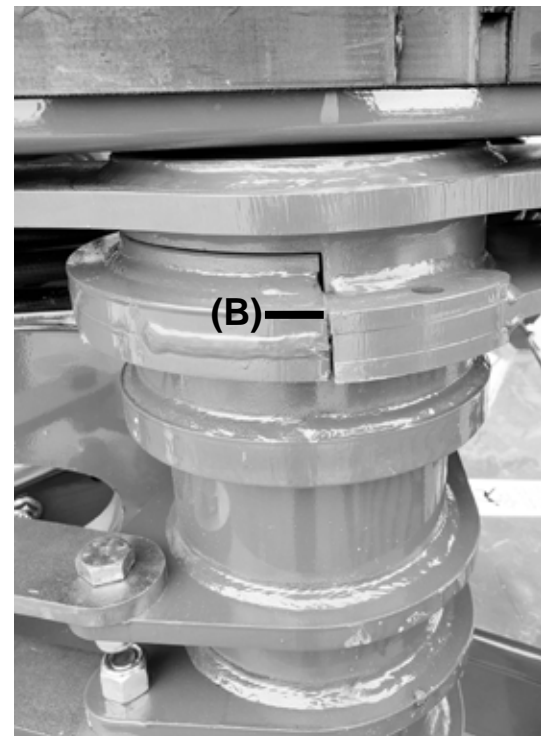

# **TRANSPORTING**

## **TOWING ON THE HIGHWAY**

Follow state and local regulations when towing farm equipment on public highways. Never tow the Windrow Merger on a public highway at a speed greater than 20 m.p.h. (32 kph).

## **LIGHTS & REFLECTORS**

Lights and reflective safety decals are on the Windrow Merger for safety.



# MACHINE PREP & OPERATION

## TRACTOR REQUIREMENTS

There are several requirements the tractor must have to ensure efficient operation of the Merger.

1. The tractor must be equipped with a 7-pin connector for proper transport and warning light function.
2. The tractor must be equipped with a 1000 RPM 1-3/8" 21 spline or 1-3/4" 20 spline PTO.
3. The tractor must be equipped with a category 2, 3N2 or 3 three point hitch (Quick Hitch would be most desirable).
4. The tractor must also be equipped with a 3-pin convenience outlet that is operated by tractor keyed power.
5. The Merger requires a minimum 95 H.P. tractor, **AND** that has a minimum tractor weight of 8,000 lbs.
6. Hydraulic Requirements
  - 2 - Remotes/SCV's
  - 12 g.p.m. per SCV
  - 2,750 p.s.i.

## MAIN TRACTOR PLUG

1. Black (Ground)
2. Red (Work Lights)
3. Yellow (Left Turn)
4. Not Used
5. Green (Right Turn)
6. Brown (Tail Lights)
7. Not Used

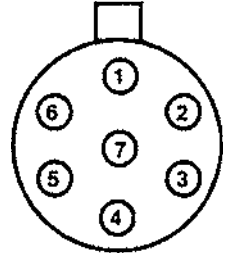

Tractor wiring may differ. Check your tractor manufacturers' electrical diagram to match to the Tri-Flex Merger's wiring.

## TRACTOR HOOK UP

### 3-Point

Connect the merger hitch to the tractor 3-point using the supplied hitch pins and adapter sleeves. Correct hitch distance from ground to center of pins is 24" to 26". If the tractor is equipped with a quick coupler make sure the latches are engaged.



# MACHINE PREP & OPERATION

## PTO

- The PTO is a direct drive system to the pump.
- Configure the proper PTO length and spline needed for the tractor. Using the two set screws supplied with PTO, connect the PTO shaft to the pump input shaft. The top PTO shield swings back with removal of driver side pin for easy access to PTO set screws. Replace the PTO shield before using the machine.
- Slide the spring loaded locking collar on the PTO yoke rearward and slide the yoke onto the tractor PTO shaft. Release spring loaded collar. Be sure the pins fall into the groove on the tractor PTO shaft and collar snaps forward into position. **CAUTION:** Do not use a steel hammer to aid in joining PTO parts.

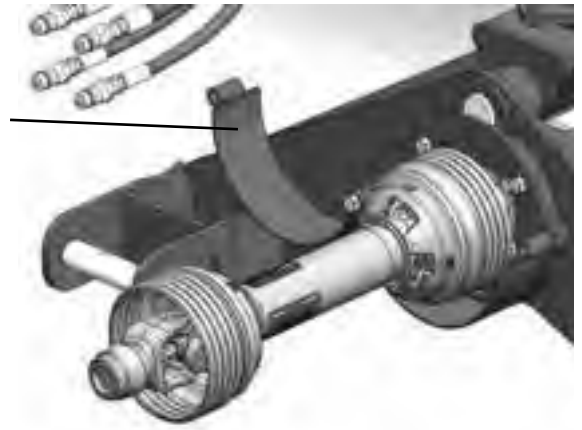

**Recommended PTO operating speed is 700-750 RPM**

## Hydraulics

- Connect the two sets of remote hoses supplied with merger to tractor remote ports.
- Each set of hoses/remotes folds/unfolds the merger heads and open/closes the deflectors.

**NOTE: AFTER the heads have contacted the ground and the deflectors are open, continue to hold the SCV/Remote control for an additional 3 to 5 seconds. This ensures the head suspension system will work properly following the ground.**

# MACHINE PREP & OPERATION

## TRACTOR HOOK UP

### Electrical

1. Install the merger main power supply cable direct to the tractor 12V batteries. Route the power supply cable so it can easily be connected to the large black round plug located at the front of the merger. Attach the power supply cable securely, making sure it will not interfere with tractor functions.

2. Mount the control box in a convenient position in the cab for easy operator access. A bracket is included with the control box to aid this process.

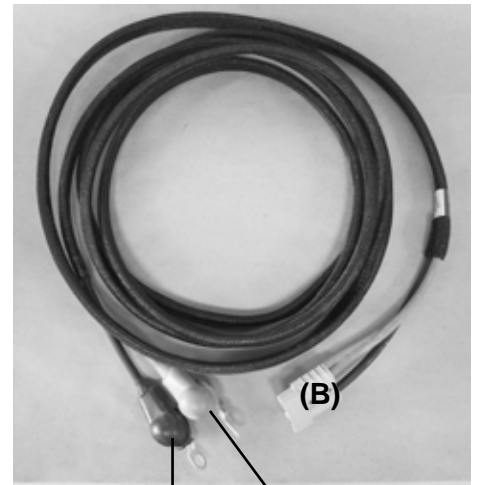

Negative & Positive  
Battery Cables

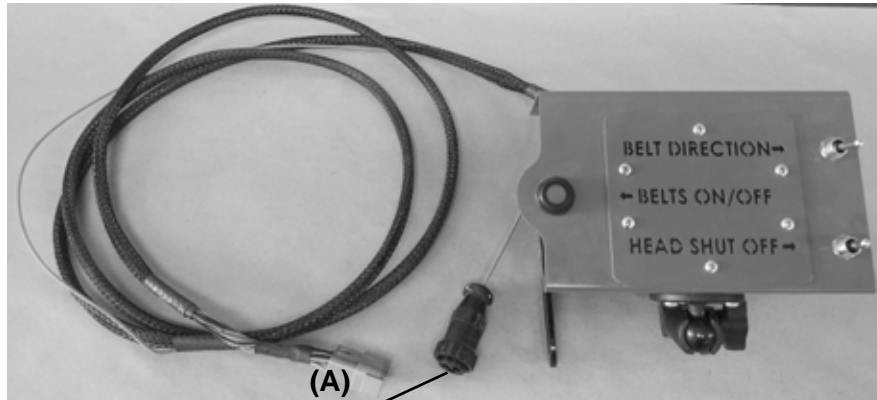

3. Connect the 3-pin cable to the tractor convenience outlet. This connection is only used for a keyed power supply for main power relay.

4. Connect the (A) plug from the control box harness to the (A) plug on the merger.

5. Connect the (B) plug on the main wire harness from the battery.

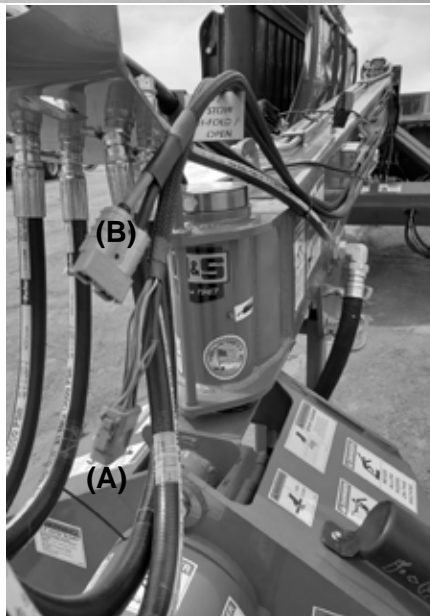

## **OPERATOR DISPLAY**

**Top Toggle Switch** is a 3-position switch. Positioning the switch to the left allows both belts to merge left, Positioning the switch in the center allows you to split, left and right. Positioning the switch to the right allows both belts to merge right.

**MIDDLE - "PUSH BUTTON"** Shuts both belts off or turns both belts on.

**BOTTOM TOGGLE** is used for merging with only one head. Whichever head is in the transport position **MUST** have the cross conveyor belt shut off with this switch.



## MACHINE PREP & OPERATION



There is a Fuse Box located at the rear of the pole with fuses to protect the electrical system.  
Position #1 - 15 amp  
Position #2 - 15 amp  
Position #3 - 7.5 amp

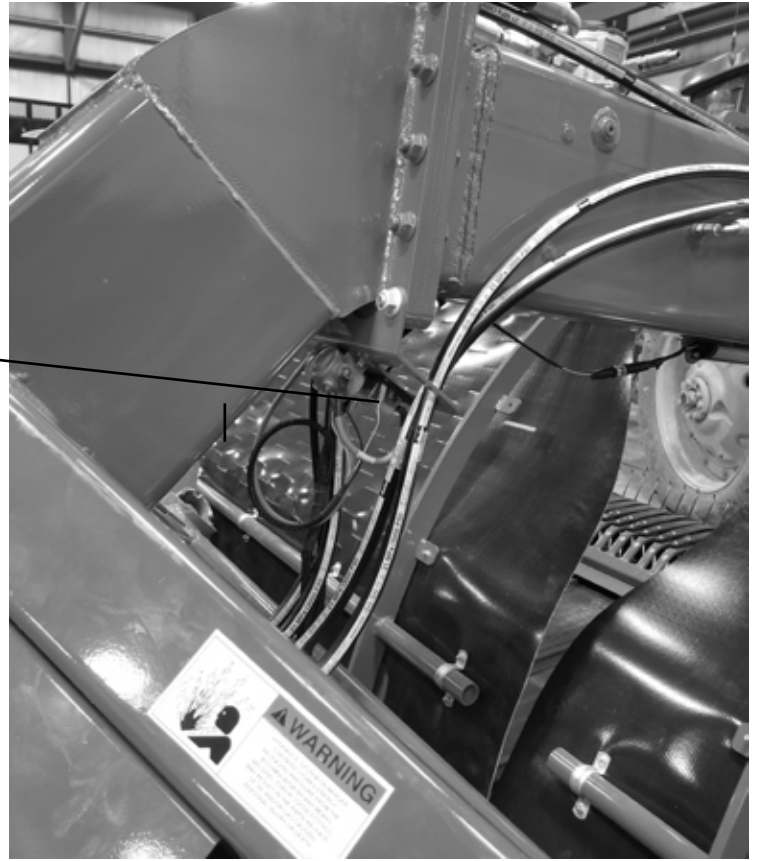

# ADJUSTMENTS

## ACCUMULATOR

### Releasing Accumulator Pressure

#### **WARNING!**

When making adjustments, the machine will see the new parameter and adjust the machine appropriately. This may cause the machine to move in the direction of the new parameter.

- **Ensure that everyone is clear of the machine when making adjustments.**
- **Ensure that everyone is clear when working on, operating, or moving the Merger.**
- **When working on high pressure hydraulic circuits, the oil can be under pressure and cut through the skin.**

#### **WARNING!**

**PRESSURE MUST BE BLED FROM THE ACCUMULATOR BEFORE REPAIRING OR REMOVING IT.**

1. Remove the **VALVE GUARD & VALVE CAP** as shown in the first picture below.
2. Attach the **GAUGE** to the **VALVE STEM** and turn in the **VALVE THUMB SCREW** to bleed the pressure from the **ACCUMULATOR** as shown in the second picture below.



### Recharging Accumulator

To recharge the **ACCUMULATOR**, (see picture below) remove the **VALVE GUARD & VALVE CAP**. Attach the **GAUGE** to the **VALVE STEM** making sure that the **VALVE THUMB SCREW** is turned out all the way (closed) before attaching. Connect the Nitrogen Tank to the **GAUGE** inlet. Turn in the **VALVE THUMB SCREW** on the **GAUGE** to open the **VALVE**. Open the **VALVE** on the Nitrogen Tank to fill the **ACCUMULATOR** to the pressure listed below.

Close the Nitrogen Tank Valve and turn the **GAUGE VALVE THUMB SCREW** all the way out to close it. After it is closed, disconnect the Nitrogen Tank and the **GAUGE**.

Install the **VALVE CAP & VALVE GUARD**. Reinstall the **ACCUMULATOR** if it has been removed.

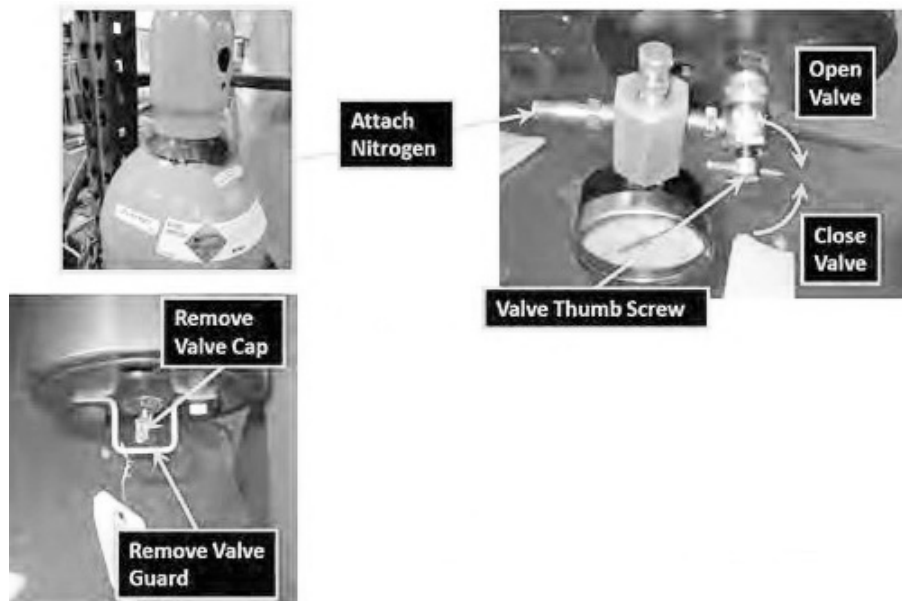

# ADJUSTMENTS

## PICKUP SPEED

The pickup speed on the Merger can only be changed by varying the tractor PTO speed. For best results, adjust the pick-up speed with the tractor rpm to match the ground speed.



## CROSS CONVEYOR SPEED

The cross conveyor speed on the Merger can only be changed by varying the tractor PTO speed. The speed relationship between the pickup and the cross conveyor is preset for an all around optimum performance level.



## CROSS CONVEYOR BELT ADJUSTMENT

**NOTE: Cross Conveyor Belts should be checked for correct tracking frequently in the first 300 acres, then daily thereafter.**

To adjust belt tracking;

1. Loosen the 2 bolts (A) that allows the belt tracking adjustment slide to move.
2. Adjust the jam nuts either way to set the belt tracking (B)
3. Tighten the (2) bolts (A) after the belt tracking is set.

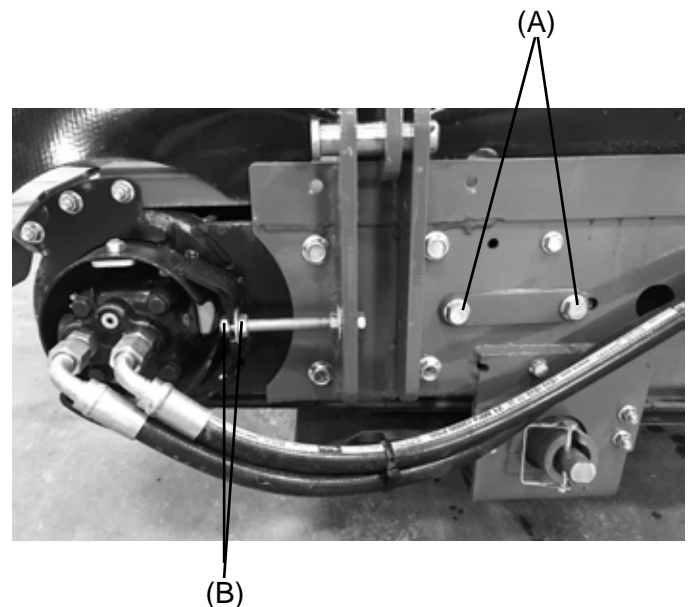

# ADJUSTMENTS

## HEADS

### Pressure Setting

The head weight pressure setting is factory set at 1600 psi. In certain field conditions, you may need to change the setting to increase or decrease the head weight.

Changing the setting;

- Move the Ball Valve Lever to the “OPEN POSITION” as shown in the bottom picture.
- Pull up on the “PRESSURE ADJUSTING LEVER” shown in the picture to INCREASE the pressure thus making the heads LIGHTER.
- Pushing down on the “PRESSURE ADJUSTING LEVER” shown in the picture DECREASES the pressure thus making the heads HEAVIER.
- After you have achieved the level of head pressure that you want, move the Ball Valve Lever to the “CLOSED POSITION” as shown in the top picture.

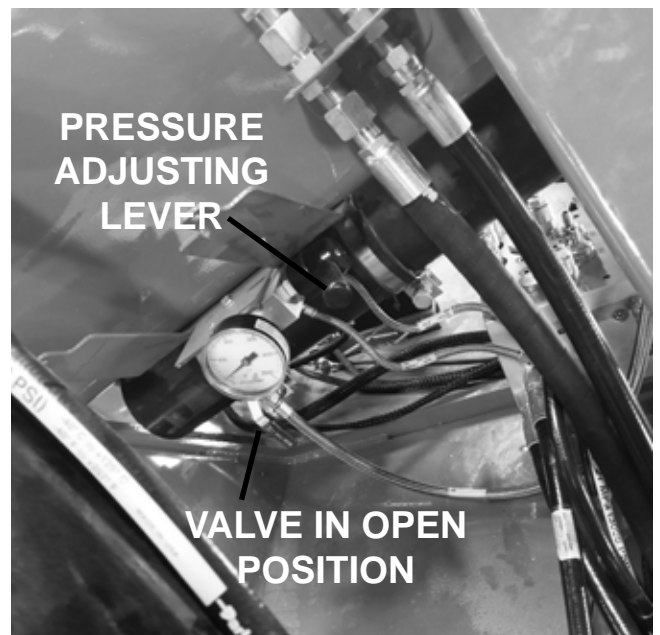
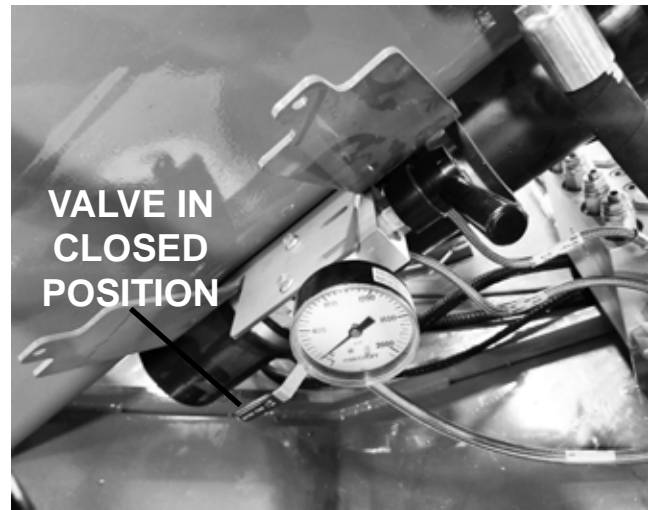

# SERVICE

## DAILY SERVICE

### Cleaning

It is a good practice to clean the entire merger at the end of each day. Getting the chaff and crop off the merger when dry will save the appearance and finish of the merger. It also gives the operator a opportunity to check the machine up close to keep it operating properly.

Before starting to merge the next day, it is good practice to engage the PTO and run the merger when it is in the transport position. This will loosen and discharge any material that has dried in the heads or cross conveyors overnight.

### Skid Shoes

Clean out the skid shoes at least once a day when the merger is in the transport position. They can become packed with debris and dirt during normal operation. Cleaning is very important for proper skid shoe operation.



### Pickups & Hay Strippers

Check the pickup teeth and hay strippers daily that none were broken or damaged by field obstructions to ensure proper field performance.



### Oil Fill & Check Plugs

Check the oil level daily by the “Cold Level Check Plug”. If oil cannot be seen at the Cold Level, remove the Fill Plug and add oil until oil starts to come out of the Cold Level hole. Re-install the Cold Level & Fill Plugs.

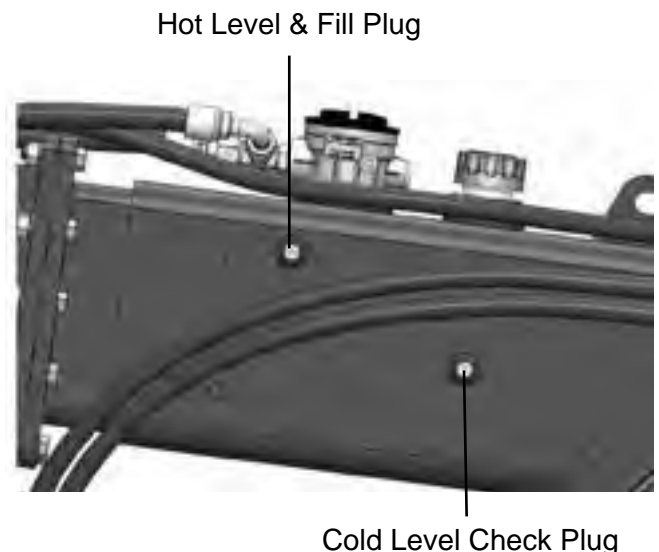

# **SERVICE**

## **ANNUAL SERVICE**

### **Cam Bearings**

Depending on the acres per year, and field conditions, the cam follower bearings should be replaced at the end of each season. They are a wear item. The outside diameter will become smaller and the bearing may fail. Replacing the bearings before failure will lengthen the life of the cam tracks.



### **Tine Bar Bearing**

Tine bar bearing should be inspected at the end of each season. They are a wear item. The two piece nylon insert was made easy to replace. Replacing these on a annual basis will insure longer tine bar life.

### **Cross Conveyor Belts**

The cross conveyor belts should all be removed at the end of each season and the inner frame work thoroughly cleaned of build-up and debris. This will ensure proper operation the next season.



# SERVICE

## ANNUAL SERVICE

### Oil Filter

The hydraulic oil filter should be changed at least once a year or prior if filter becomes clogged during the season.

If the filter pressure gauge reads 15 - 20 p.s.i., the filter is becoming clogged.

To change the filter;

1. Unscrew the filter cover.
2. Carefully remove & discard the used filter cartridge.
3. Insert the new oil filter cartridge.
4. Replace filter cover.



### Head Gearboxes

Each center cam gearbox uses 26 ounces of SAE 30W motor oil. The oil in the (2) head gearboxes should be changed on an annual basis.

Fill & Check  
Plug

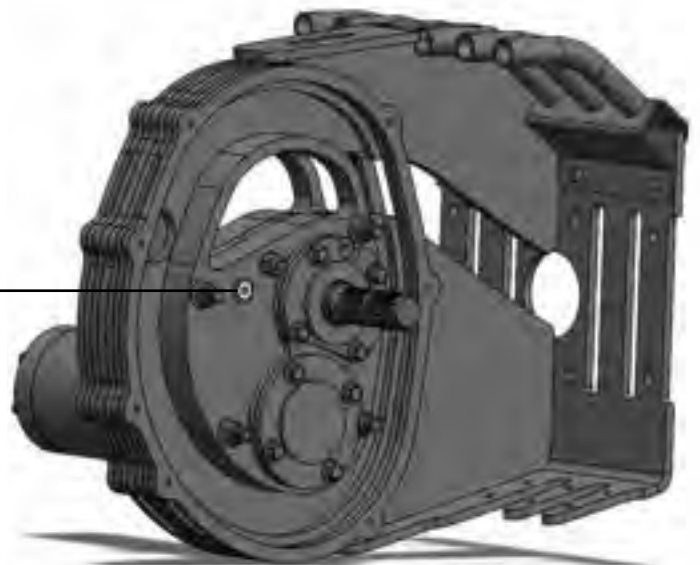

## **OPTIONS & SERVICE**

### **Remote Filter**

There is a dealer installed Remote Filter option available to filter any particles that come from the tractor hydraulic system. The R.H. picture shows removal of one of the filters for cleaning. A allen style wrench is used for removing the plug.

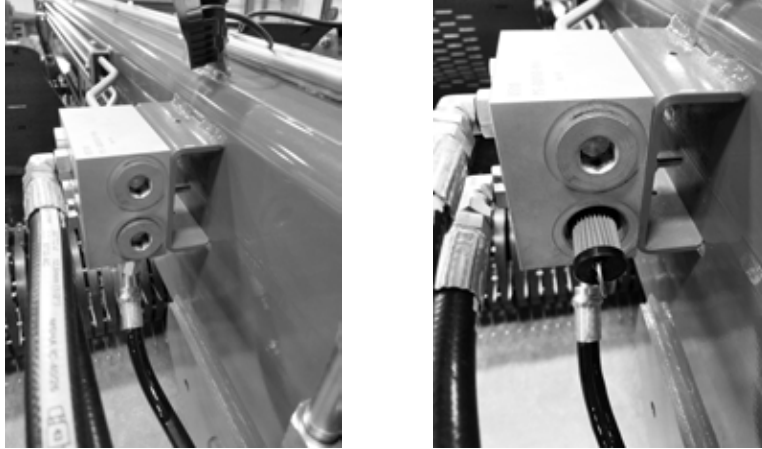

### **TFOHSS Hydraulic Skid Shoe Kit**

### **TFODDCC Dual Drive Cross-Conveyor Kit**



# LUBRICATION

## GENERAL INFORMATION

**IMPORTANT:** *Catch and dispose of fluid per local waste disposal regulations whenever service is performed on hydraulic components (valves, cylinders, hoses, etc.) or transmission.*

There are numerous grease fittings on your merger. If these are lubricated properly and often enough, it will prolong the life of the merger. Grease daily during normal use and **before and after storage and after power washing.** Use a good grade of high quality grease. Make sure grease comes out around the shaft on the sleeve type bearings. On the sealed ball bearings, grease should be added slowly until a slight bead forms at the seals indicating the correct amount of lubricant. Wipe off excess grease to prevent accumulation of grit around the bearings.

For the center cam gearboxes, use SAE30W motor oil. The gearboxes hold 26 ounces of oil.

The tongue reservoir holds 32 gallons of ISO 46 hydraulic oil. The complete system hold 42 gallons

- A. (2) Zerks - One on each wheel hub.
- B. (3) Zerks - PTO - One on each u-joint and one on the slide tube.
- C. (6) Zerks - One on each end of each pickup head.
- D. (2) Zerks - One on each head pivot.
- (20) Zerks - Suspension System - 10 on each side.
- E. (4) Zerks - One on each side of the cam on each head

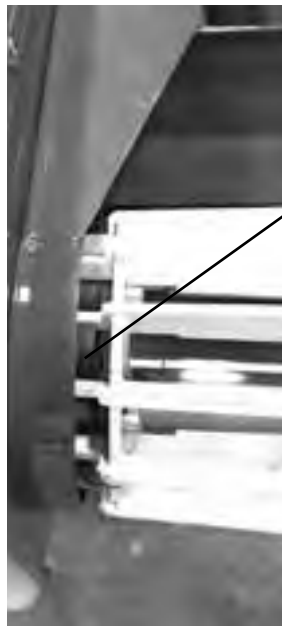

(4 Zerks)  
Cross  
Conveyor  
Idler  
Bearings,  
1 zerk on  
the front  
side of each  
roller.  
Grease  
**ANNUALLY**  
when belts are  
removed

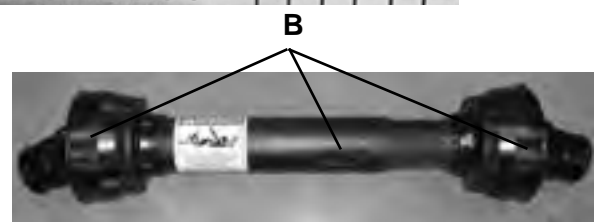

# DECAL LOCATION

Your H&S Merger was manufactured with operator safety in mind. Located on the merger are various decals to aid in operation, and warn of danger or caution areas. Pay close attention to all the decals on your windrow merger.



**DO NOT REMOVE ANY OF THESE DECALS. IF DECALS ARE LOST, DAMAGED, OR IF YOUR WINDROW MERGER IS REPAINTED, REPLACE THE DECALS. REMEMBER: DECALS ARE FOR YOUR PROTECTION AND SAFETY.**

<u>Part #</u>	<u>Qty.</u>	<u>Description</u>
311	1	Patent Numbers
1494L	1	Danger - Rotating Driveline
1494P	2	Danger - Maintain Safe Clearance
1906C	19	Warning - Stay Clear
5896B	2	Danger - Rotating Driveline
9194A	1	No Step-Stay Clear
11599	7	Warning - Do Not Go Near Leaks
12502A	2	Danger - Stay Clear of Extension
31401	2	Danger - Stay Clear of Merger
32597A	2	Do Not Operate w/Decal Exposed
54033	1	Made In America (4 1/2")
72203A	1	Warning - Help Avoid Injury
73101	5	Danger - Stay Clear of Moving Parts
82602	1	Warning - Crushing Hazard
82907L	3	Danger - Never Allow Riders
83773	1	H&S Branding Decal
83774	1	H&S Branding Decal
83775	2	6128 Model Number
84044	1	FEMA
84045	1	H&S Since 1967
88994	1	Control Box Decal - Do Not Run Belts
093020	26	Grease
DC32211A	6	Warning - Stay Clear Contact With Tines
DC32211B	7	Warning - Slag Generated By Heating
DCRED	2	2" x 9" Red Reflector
DCAMB	4	2" x 9" Amber Reflector

# DECAL LOCATION

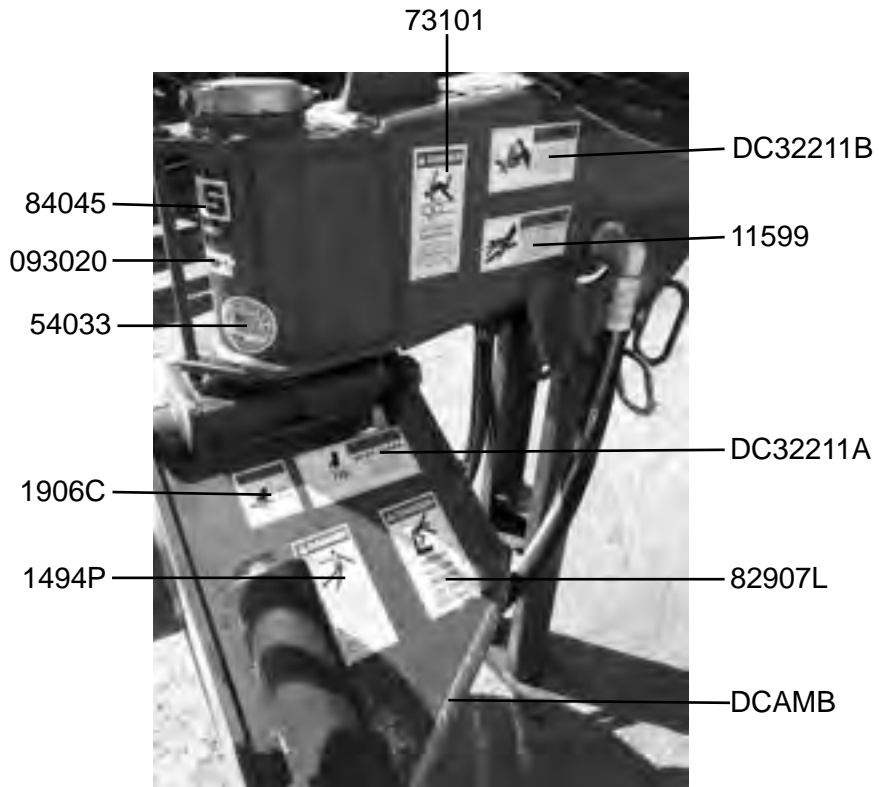
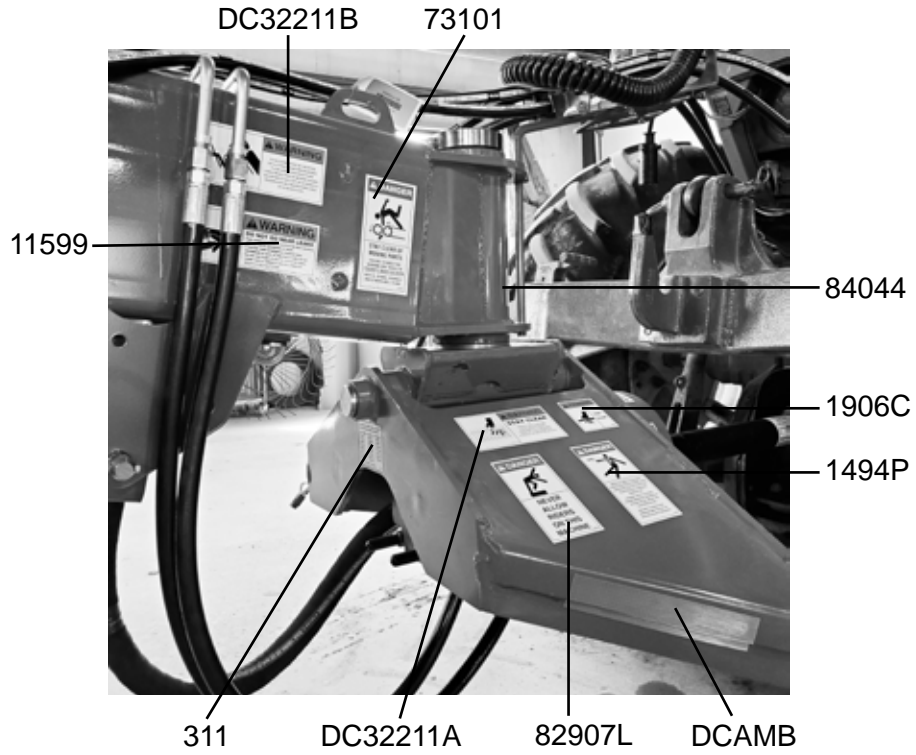

# DECAL LOCATION



# DECAL LOCATION

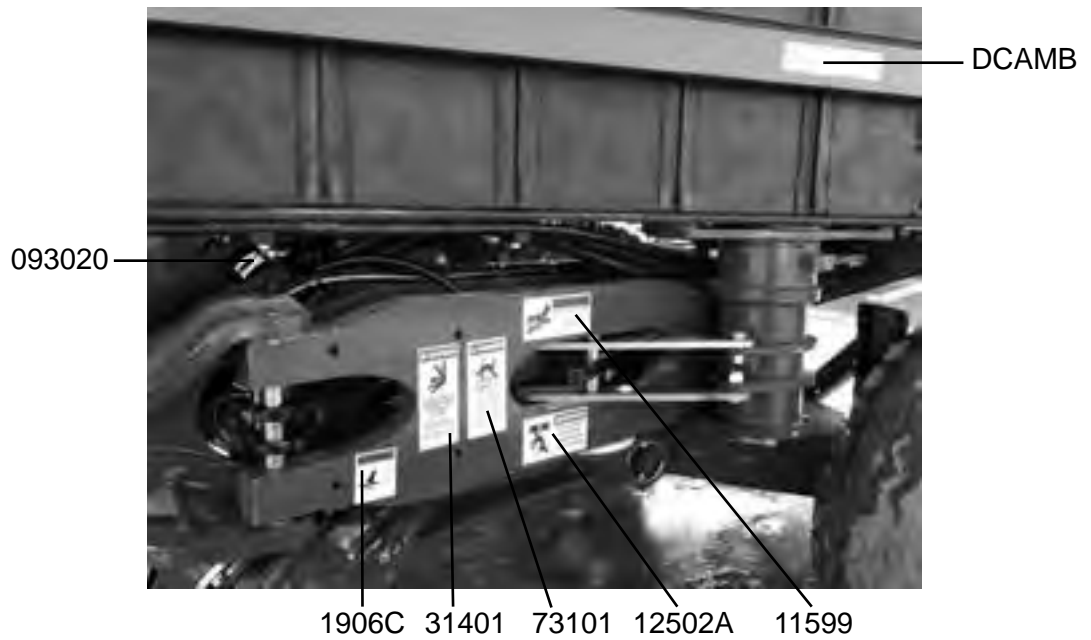
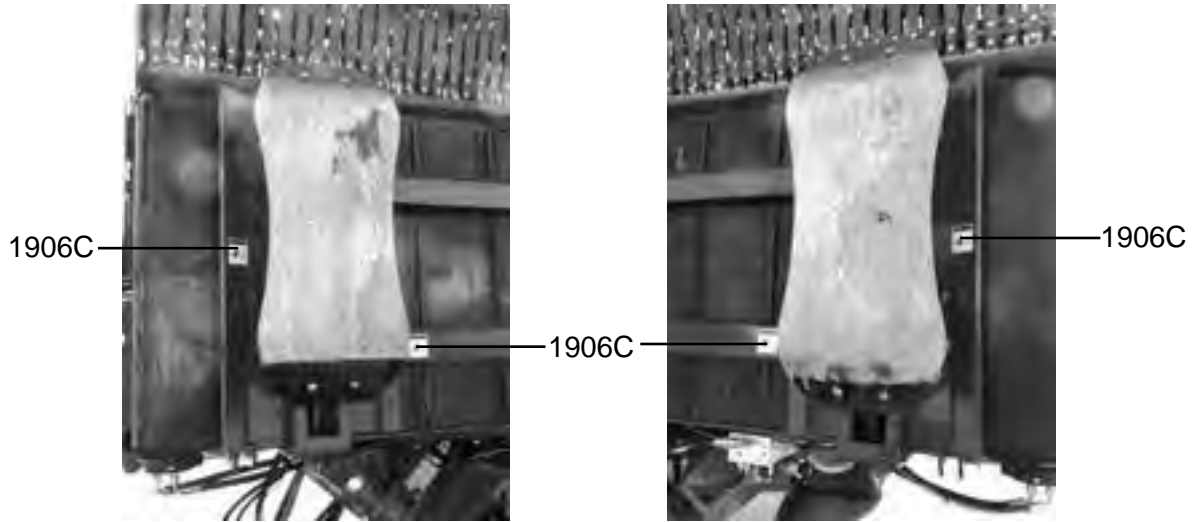

# DECAL LOCATION

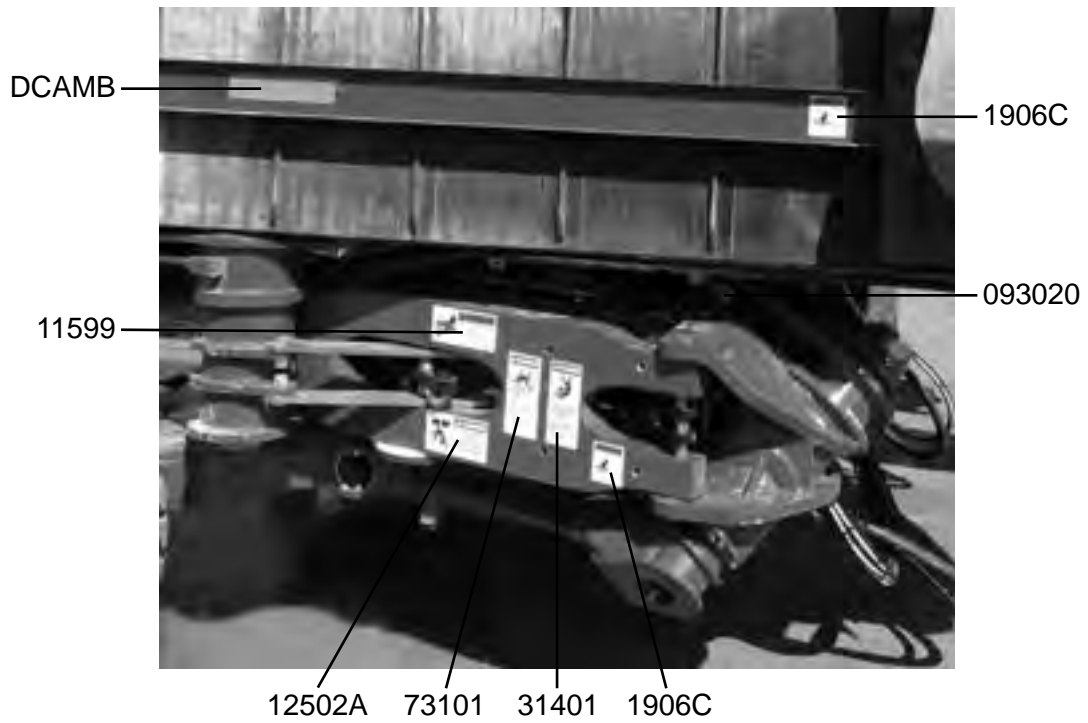
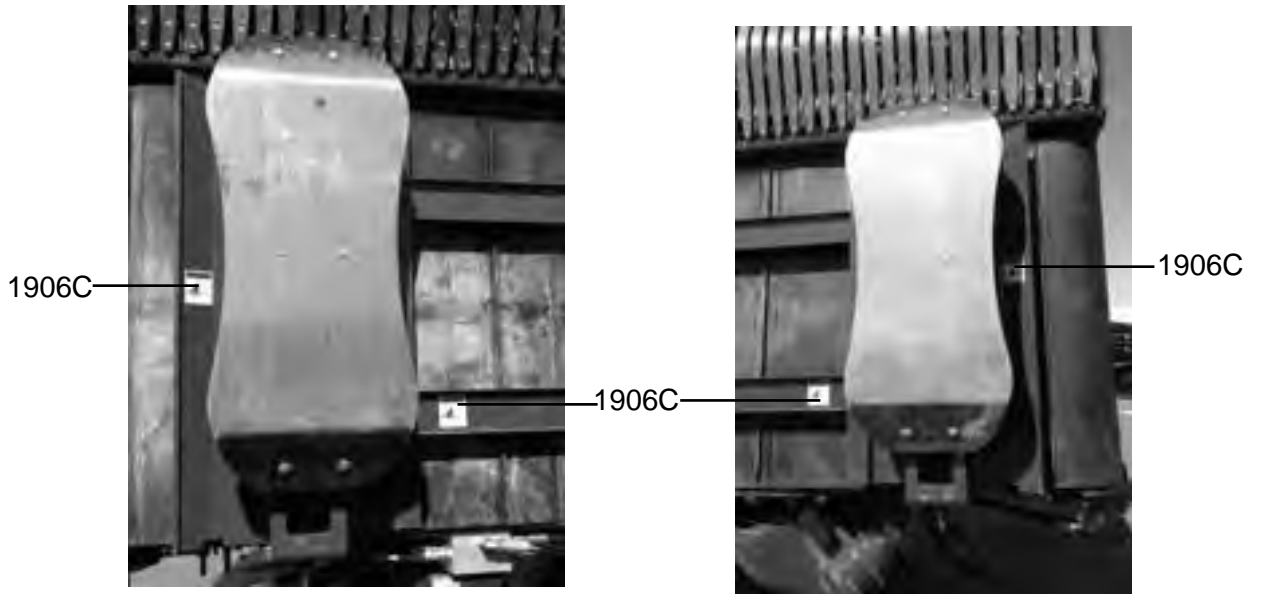

# DECAL LOCATION

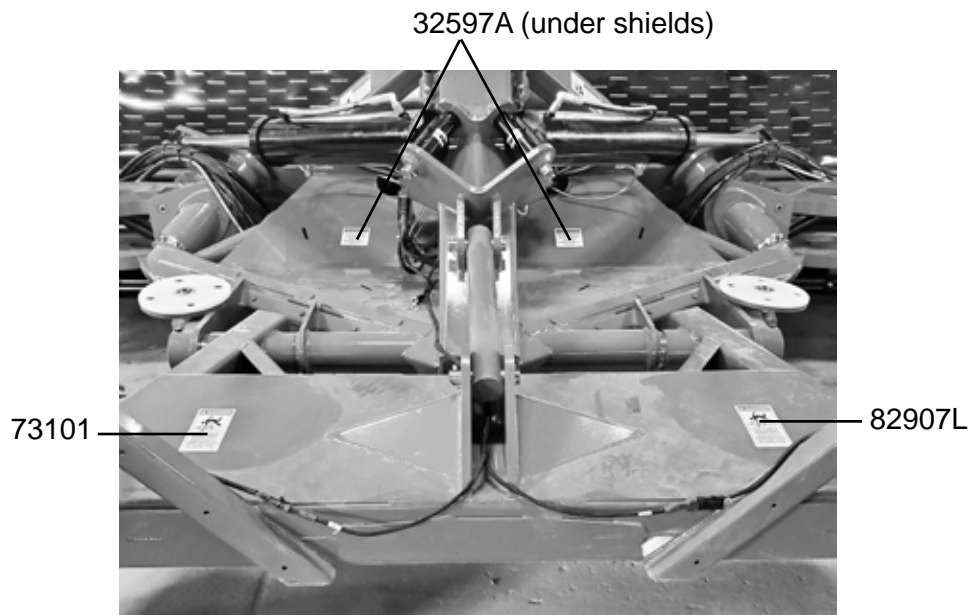
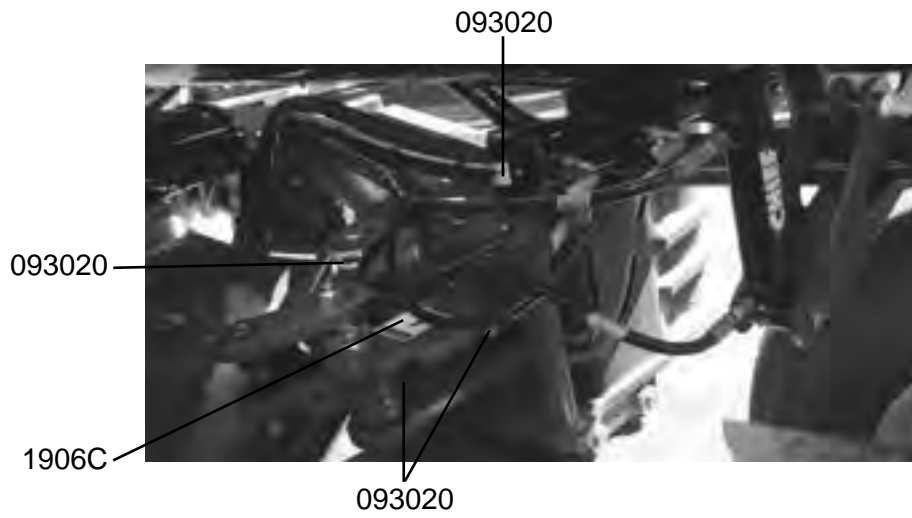
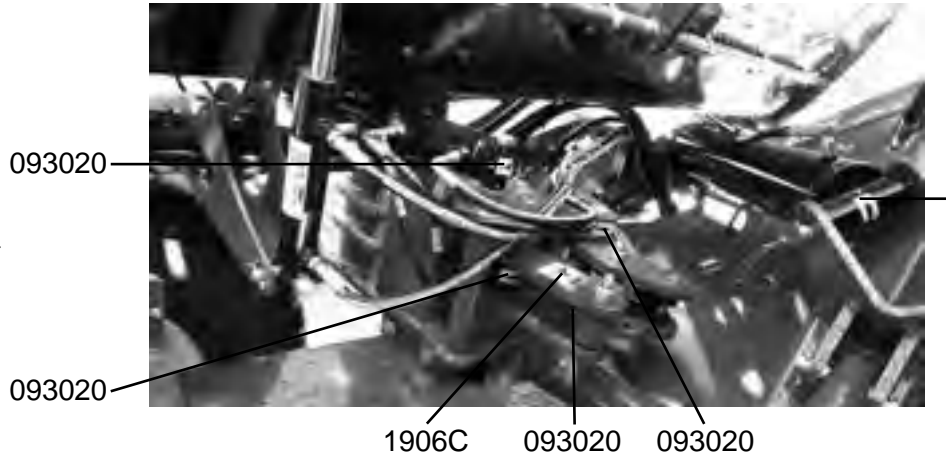

# DECAL LOCATION

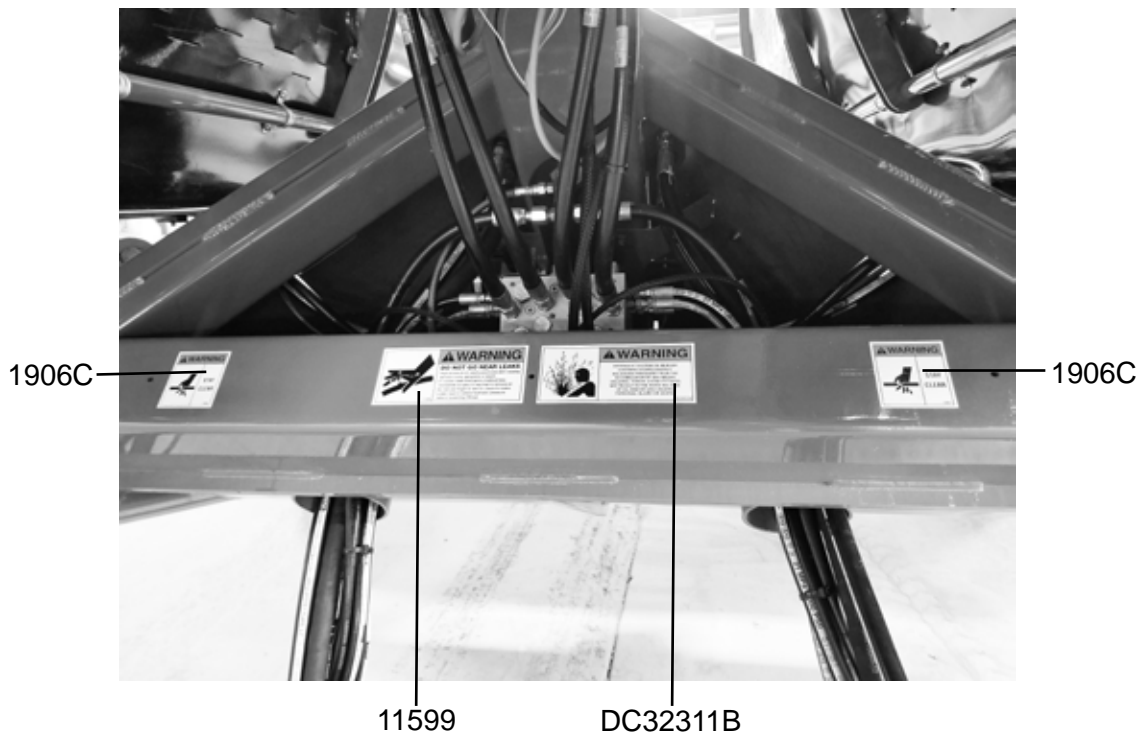
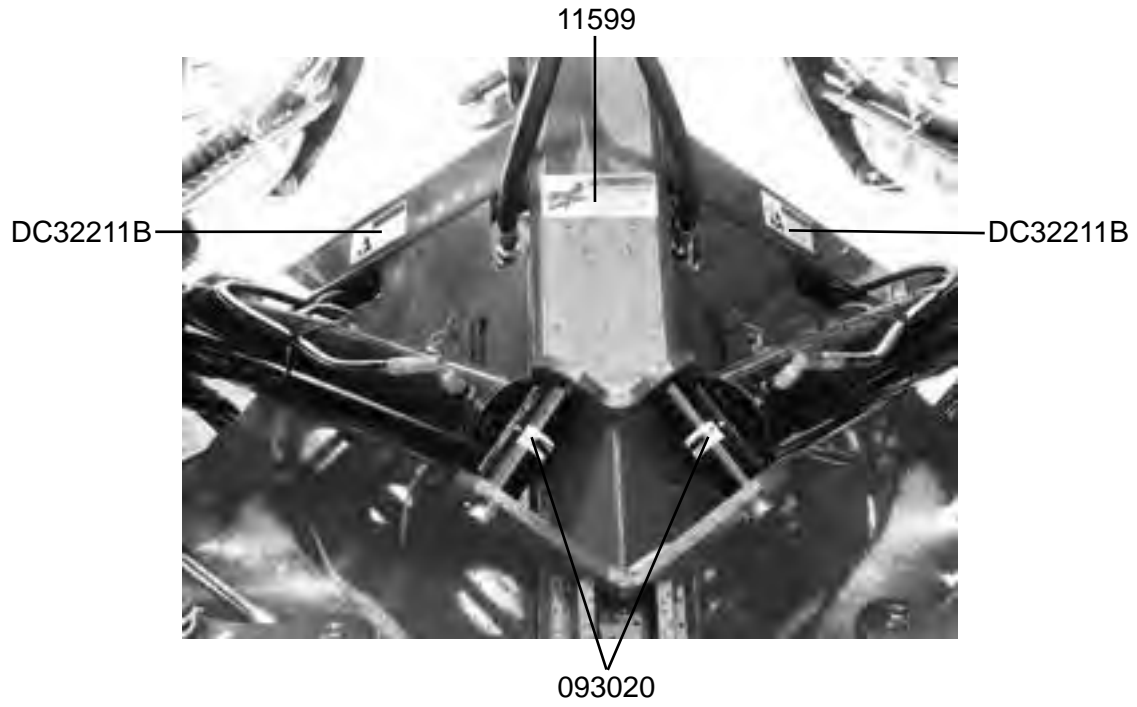



# DECAL LOCATION

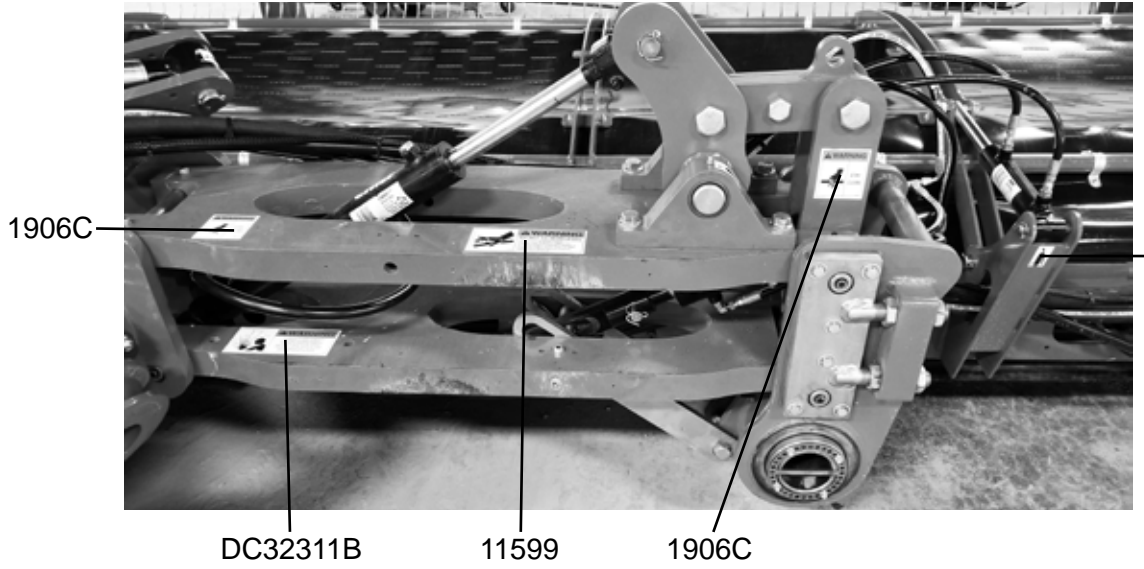

## Left & Right Head Decals (Both Sides are Identical)

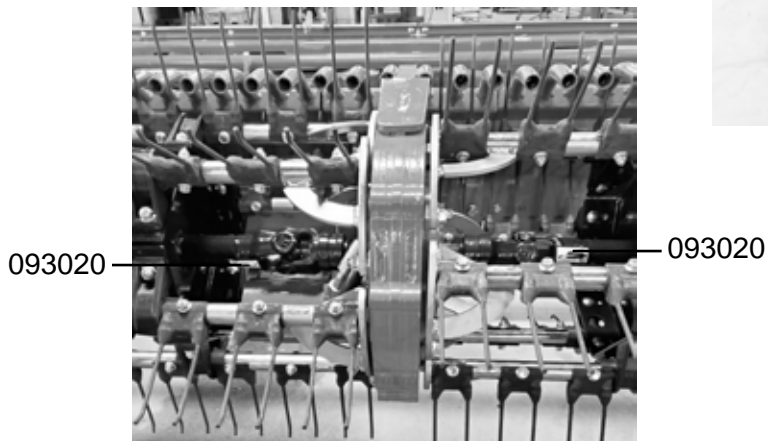
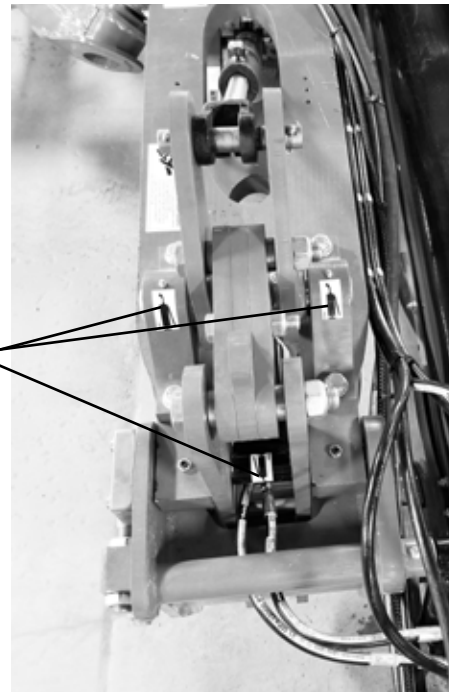
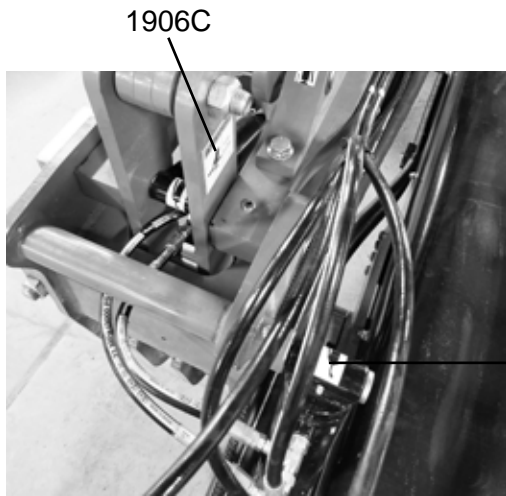

# DECAL LOCATION

093020



DC32211A

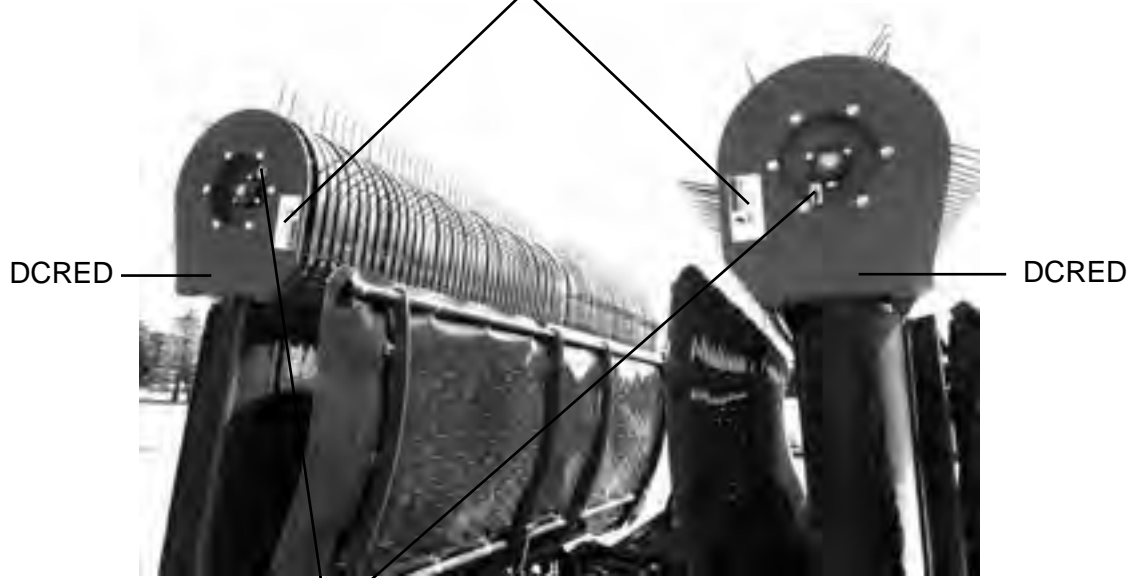

093020

88994









H&S MFG. CO.

products approved

for the

FEMA

SEAL OF QUALITY

