



OPERATOR'S MANUAL

TF6132
TWIN-FLEX
MERGER

Part #94539
Rev. #01
HSMFG050323

Starting Serial #321TF63201



WARNING

READ AND UNDERSTAND THIS MANUAL BEFORE OPERATING THIS EQUIPMENT. UNSAFE OPERATION OR MAINTENANCE OF THIS EQUIPMENT CAN RESULT IN SERIOUS INJURY OR DEATH.

CONTENTS

Warranty	1
Manufacturer's Statement	2
Warranty Registration Form	3
Dealer Pre-Delivery Checklist	5
Dealer Delivery Checklist	7
Be Alert Symbol	9
Explanation of Safety Signs	10
Warning - Owner Must Read and Understand	11
Cap Screw Torque Values	12
Hydraulic Fitting Torque Specifications	13-14
Set-Up & Assembly	15
Transporting	16
Machine Prep & Operation	17-19
Operator Display	20-29
Adjustments	30-33
Service	34-36
Operating Without Electronics	37
Optional Equipment	38
Lubrication Guide	39-45
Decal Location & Identification	46-62
Service Notes	63

WARRANTY

H&S Manufacturing Co., Inc. ("H&S") warrants this product to be free from defect in material and workmanship. Except as noted below, this warranty term is twelve (12) months on parts and labor from the date of delivery of the product to the original purchaser by an authorized H&S dealer. Under this warranty, H&S will repair or replace, at its option, any covered part which is found to be defective in material or workmanship during the applicable warranty term. In no case will the covered repair cost of a part or parts exceed the replacement cost of that part. In no case, unless pre-authorized by H&S, will a component be replaced versus repaired unless the cost of labor and parts exceeds 75% of the cost of a new component. Warranty repairs must be performed by H&S or a dealer authorized by H&S to sell and/or service the product involved, and will use only new or remanufactured parts or components furnished by H&S. Any warranty repairs needing to be performed by a third party must be pre-authorized by H&S. Standard freight costs will be covered by H&S for any part used to make a warrantable repair, any form of express freight will not be covered unless pre-authorized by H&S. This warranty includes approved parts and labor to repair the product but does not include, and the purchaser is responsible for, any service call and/or transportation of the product to and from the dealer's place of business, for any costs related to travel, for any premium charged for overtime labor requested by the purchaser, and for any service work not directly related to any defect covered under this warranty. This warranty includes only those components of the product manufactured by H&S. Warranty for any component not manufactured by H&S including, but not limited to, engines, batteries, tires, rims, hydraulic motors, pumps, etc. are covered by the warranty, if any, provided separately by their respective manufacturers. H&S reserves the right to request the return of any failed component.

This warranty in all its parts is extended solely to the original purchaser of the product, is terminated upon any subsequent transfer or sale from or by the original purchaser, and extends no third party benefits or rights whatsoever.

The warranty term for any product used in any for hire, rental fleet or rental application, is limited to six (6) months from the date of delivery of the product to the original purchaser by an authorized H&S dealer.

This warranty does not include: (1) Any product that has been altered or modified in ways not approved by H&S; (2) Depreciation or damage caused by normal wear, use for which the product was not designed, misuse, improper or insufficient maintenance, improper operation, accident or failure to follow the product Operator's Manual recommendations and product decal recommendations; (3) Normal maintenance parts and service; (4) Repairs made with parts other than those available from H&S or performed by anyone other than H&S or a dealer authorized by H&S to sell and/or service the product involved.

To secure warranty service the purchaser must report the product defect to a dealer authorized by H&S to sell and/or service the product involved within the applicable warranty term together with evidence of the warranty start date and make the product available to that dealer within a reasonable period of time. For these warranty terms to be in effect the selling authorized H&S dealer and/or the customer must submit the warranty registration to H&S.

THERE ARE NO WARRANTIES WHICH EXTEND BEYOND THE DESCRIPTION ON THE FACE OF THIS WARRANTY. H&S and the companies affiliated with it make no warranties, representations, or promises, express or implied, as to the performance or freedom from defect of its products other than those set forth above and NO IMPLIED WARRANTY OF MERCHANTABILITY, FITNESS OR FITNESS FOR A PARTICULAR PURPOSE IS MADE. IN NO EVENT WILL THE DEALER, H&S OR ANY COMPANY AFFILIATED WITH H&S BE LIABLE FOR INCIDENTAL OR CONSEQUENTIAL DAMAGES. The ONLY REMEDY the purchaser has in connection with the breach of performance of any warranty on H&S products are those set forth above.

The selling dealer has no authority to make any representation or promise on behalf of H&S, or to modify the terms or limitations of this warranty in any way.

12/21/22

MANUFACTURER'S STATEMENT

Your New H&S Product has been manufactured of the finest quality materials and components. The performance you get from your machine is largely dependent upon how well you read and understand this manual and apply this knowledge. There is a right and a wrong way to do everything. Please do not assume that you know how to operate and maintain your Machine before reading this manual carefully. Keep this manual available for ready reference.

H&S reserves the right to make changes or add improvements to its products at any time without incurring any obligation to make such changes to products previously manufactured. Specifications, statements and descriptions of Products contained in this publication are subject to change without prior notification.

WARRANTY REGISTRATION

- Date of Purchase: _____
- Purchaser Name: _____
- Street Address: _____
- City: _____
- State: _____ Zip: _____
- Phone Number: _____
- E-mail Address: _____
- Product: _____
- Model Number: _____
- Serial Number: _____
- You have received the Operator's Manual for this product. Yes _____ No _____
- Interested in receiving the H&S E-mail Newsletter? Yes _____ No _____

-
- Dealer Name: _____
 - Street Address: _____
 - City: _____
 - State: _____ Zip: _____
 - Signature: _____

- All fields must be filled out to ensure prompt notification of product and/or warranty updates.

**Please mail the completed WARRANTY REGISTRATION FORM to:
H&S Manufacturing Co., Inc.
2608 S. Hume Ave.
Marshfield, WI 54449**

Intentionally Left Blank

DEALER PRE-DELIVERY CHECKLIST

AFTER COMPLETION, DEALER SHOULD REMOVE AND RETAIN FOR RECORDS

After the Merger has been completely set up, check to be certain it is in correct operating order before delivering to the customer. The following is a list of points to inspect. Check off each item as you have made the proper adjustments and found the item operating satisfactorily.

- Merger was not damaged in shipment. Check for dents and loose or missing parts. Report damage immediately to H&S Manufacturing Co., Inc.
- Merger has been correctly assembled according to dealer set up instructions. Wheel nuts and all other fasteners are tightly secured.
- Visually look over machine for any loose hardware.
- All grease fittings have been lubricated. See LUBRICATION section of this manual for details.
- Hoses and fittings are properly attached and there are no visible leaks.
- All belts are at proper tension.
- PTO Shields turn freely.
- All shields and guards are in place and fastened.
- All mechanisms are operating trouble free.
- Tires are inflated to correct pressure.
- Decals are in place and legible.
- Hook machine to tractor to make sure four green lights are visible. One on the main controller and three on the cam expanders.

Model Number _____

Serial Number _____

Dealer's Name _____

Inspection Date _____

Signature of Pre-Delivery Inspector _____

(Remove Dealers File Copy At Perforation)

Intentionally Left Blank

DEALER DELIVERY CHECKLIST

AFTER COMPLETION, DEALER SHOULD REMOVE AND RETAIN FOR RECORDS

This check list that follows is an important reminder of valuable information that should be passed on to the customer at the time this Merger is delivered.

Check off each item as you explain it to the customer.

This delivery checklist, when properly filled out and signed assures the customer that the pre-delivery service was satisfactorily performed.

- Explain to the customer that the pre-delivery inspection was made.
- Explain to the customer all the safety precautions they must exercise when operating this unit.
- Explain to the customer the operation and adjustments of the Merger.
- Explain to customer that regular lubrication is required for proper operation and long life of the machine.
- Show the customer the LUBRICATION section of Operator's Manual.
- Give the customer Operator's Manual and make sure they read and understand all operating and service instructions.
- Have the customer sign a completed "Warranty Registration" and mail it.

Date Delivered _____

Dealer's Name _____

By _____

Signature of Original Buyer _____

Note: Warranty is not valid until warranty card is completed and returned to H&S Mfg. Co., Inc.

Intentionally Left Blank

SAFETY INFORMATION

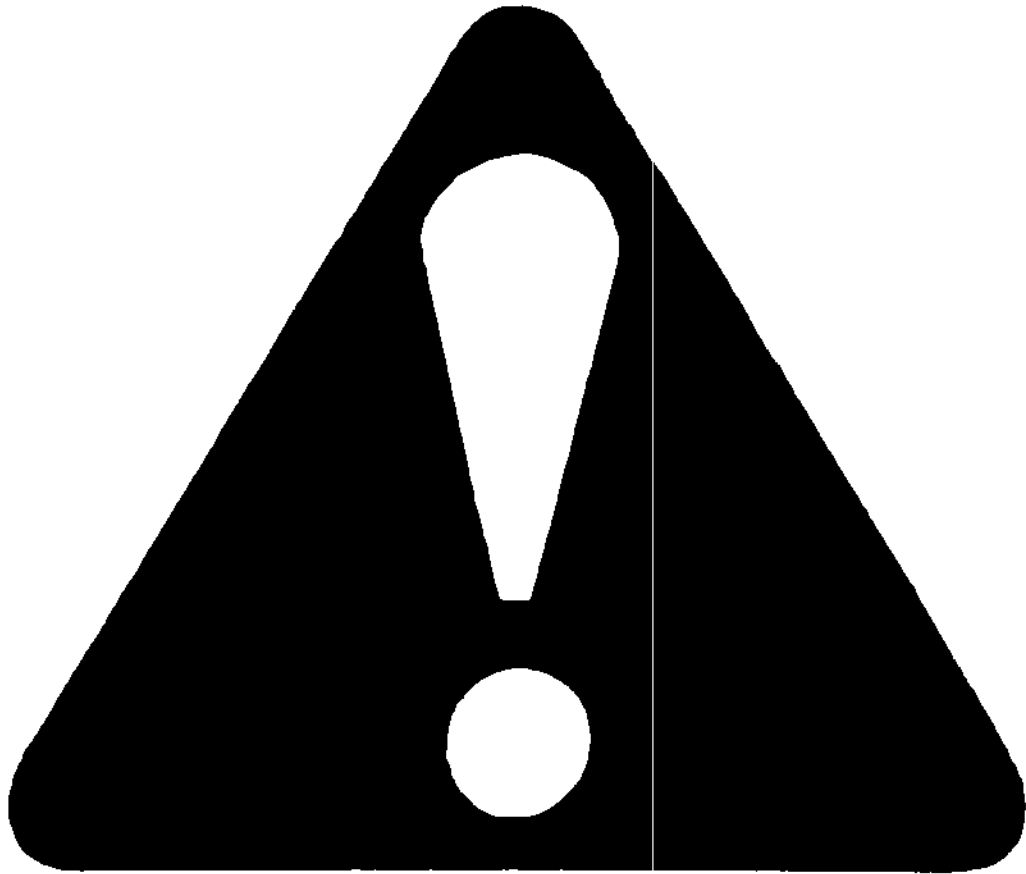

**BE
ALERT!**

**YOUR SAFETY
IS INVOLVED.**

THIS SYMBOL IS USED THROUGHOUT THIS BOOK WHENEVER YOUR PERSONAL SAFETY IS INVOLVED. TAKE TIME TO BE CAREFUL. REMEMBER: THE CAREFUL OPERATOR IS THE BEST OPERATOR. MOST ACCIDENTS ARE CAUSED BY HUMAN ERROR. CERTAIN PRECAUTIONS MUST BE OBSERVED TO PREVENT THE POSSIBILITY OF INJURY OR DAMAGE.

H&S MANUFACTURING CO., INC.

SAFETY INFORMATION

RECOGNIZE SAFETY INFORMATION

This is the safety alert symbol. When you see this symbol on your machine or in this manual, be alert to the potential for personal injury.

Follow recommended precautions and safe operating practices.



UNDERSTAND SIGNAL WORDS

A signal word - DANGER, WARNING, or CAUTION - is used with the safety alert symbol. DANGER identifies the most serious hazards.

Safety signs with signal word DANGER or WARNING are typically near specific hazards.

General precautions are listed on CAUTION safety signs.



FOLLOW SAFETY INSTRUCTIONS

Carefully read all safety messages in this manual, and all safety signs on your machine. Follow all recommended precautions and safe operating procedures.

Keep signs in good condition. Immediately replace any missing or damaged signs.

OBSERVE MAXIMUM TRANSPORT SPEED

The maximum transport speed for this implement is 32 km/h (20 mph).

Some tractors are capable of operating at speeds that exceed the maximum transport speed of this implement. Regardless of the maximum speed capability of the tractor being used to tow this implement, do not exceed the implement's maximum transport speed.

Exceeding the implement's maximum transport speed can result in:

- * Loss of control of the tractor/implement combination
- * Reduced or no ability to stop during braking
- * Implement tire failure
- * Damage to the implement structure or its components

Use additional caution and reduce speed when towing under adverse surface conditions, when turning, and when on inclines.

Do not attempt transport if the fully loaded implement weighs more than 1.5 times the weight of the tractor.



SAFETY INFORMATION

TRACTOR:

This Operator's Manual uses the term "Tractor" when identifying the power source.



TO PREVENT SERIOUS INJURY OR DEATH

BEFORE YOU ATTEMPT TO OPERATE THIS EQUIPMENT, READ AND STUDY THE FOLLOWING INFORMATION. IN ADDITION, MAKE SURE THAT EVERY INDIVIDUAL WHO OPERATES OR WORKS WITH THIS EQUIPMENT, WHETHER FAMILY MEMBER OR EMPLOYEE, IS FAMILIAR WITH THESE SAFETY PRECAUTIONS.

DO NOT ALLOW PERSONNEL OTHER THAN THE QUALIFIED OPERATOR NEAR THE MACHINE.

KNOW HOW TO STOP MACHINE BEFORE STARTING IT.

BEFORE starting tractor, be sure PTO shields turn freely and PTO is securely locked to tractor.

Stop the tractor engine, remove ignition key and allow all mechanisms to stop before cleaning or working on the machine.

If the machine becomes clogged or requires servicing, disengage the tractor PTO or tractor hydraulics.

DO NOT attempt to perform maintenance or repair with tractor running and PTO or tractor hydraulics hooked up.

DO NOT step up on machine at any time.

NEVER manually feed material into the pickup.

DO NOT allow minors to operate or be near the machine.

DO NOT clean, adjust, or lubricate the machine when any part is in operation.

STAY CLEAR of machine when rasing and lowering machine and during folding and unfolding machine.

KEEP hands, feet, and clothing away from pickup conveyor belts WHEN THEY ARE IN MOTION.

LOOSE and floppy clothing should not be worn by the operator.

BE SURE the machine is clear of people tools, and other objects before engaging PTO or tractor hydraulics.

STAY CLEAR of hydraulic lines and fittings. They may be under extreme pressure or heat.

NEVER start the Merger until all guards and safety shields are in place.

CAUTION - Beware of low electrical wires.

H&S Manufacturing Co. always takes the operator and their safety into consideration and guards exposed moving parts for their protection. However, some areas cannot be guarded or shielded in order to ensure proper operation. In addition, the operators manual and decals on the machine itself warn you of further danger and should be read and observed closely.

Study The Above Safety Rules

ATTENTION - BE ALERT - YOUR SAFETY IS INVOLVED

CAP SCREW TORQUE VALUES

The specifications below are the torque values for fasteners as it adheres to the SAE torque value standards. All fasteners should be torqued to the proper values found in the figures below unless otherwise specified by the engineering drawing.

Lubed torque would be any fastener that has grease, liquid Loctite, oil, etc. on the threads.

Dry torque would be any fastener which has threads that are clean and dry and do not have any liquid Loctite or grease on them.

Hex Head Fasteners

The figure shown below shows how to determine what grade a fastener is.

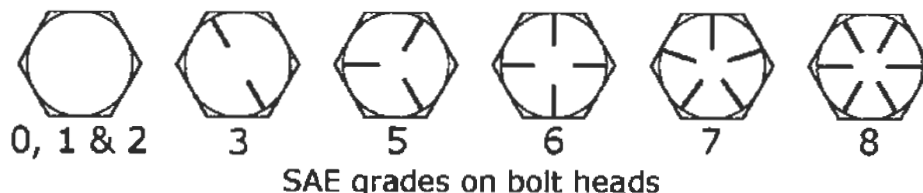

SUGGESTED ASSEMBLY TORQUE VALUES							WORKING TORQUE			
Diam & Thrds Per Inch	SAE GRADE 2 -6"		SAE GRADE 5		SAE GRADE 8		18-8 SS	316 SS	BRASS	SILICON BRONZE
	Dry FT. LB.	LUB FT. LB.	Dry FT. LB.	LUB FT. LB.	Dry FT.LB.	LUB FT LB.	IN LBS	IN LBS	IN LBS	IN LBS
1/4-20	5.5	4.2	8	6.3	12	9	75.2	78.8	61.5	68.6
1/4-28	6.3	4.7	10	7.2	14	10	94.0	99.0	77.0	87.0
5/16-18	11	8	17	13	24	18	132	138	107	123
5/16-24	12	9	19	14	27	20	142	147	116	131
3/8-16	20	15	30	23	45	35	236	247	192	219
3/8-24	23	17	35	25	50	35	259	271	212	240
7/16-14	32	24	50	35	70	50	376	393	317	349
7/16-20	36	27	55	40	80	60	400	418	327	371
1/2-13	50	35	75	55	110	80	517	542	422	480
1/2-20	55	40	85	65	120	90	541	565	443	502
9/16-12	70	55	110	80	150	110	682	713	558	632
9/16-18	80	60	120	90	170	130	752	787	615	697
5/8-11	100	75	150	110	210	160	1110	1160	907	1030
5/8-18	110	85	170	130	240	180	1244	1301	1016	1154
3/4-10	175	130	260	200	380	280	1530	1582	1249	1416
3/4-16	200	140	300	220	420	310	1490	1558	1220	1382
7/8-9	170	125	430	320	600	450	2328	2430	1905	2140
7/8-14	180	140	470	350	670	500	2318	2420	1895	2130
1-8	250	190	640	480	910	680	3440	3595	2815	3185
1-14	280	210	720	540	1020	760	3110	3250	2545	2885

HYDRAULIC FITTING TORQUE SPECIFICATIONS

Tapered Pipe Thread Size - Assembly turns from Finger Tight (TFFT) for Tapered Threads		TFFT
BSPT (Uncommon)	NPTF (Common)	
1/8-28	1/8-27	2 - 3
1/4-19	1/4-18	2 - 3
3/8-19	3/8-18	2 - 3
1/2-14	1/2-14	2 - 3
3/4-14	3/4-14	2 - 3
1-11	1-11 1/2	1.5 - 2.5
1 1/4-11	1 1/4-11 1/2	1.5 - 2.5
1 1/2-11	1 1/2-11 1/2	1.5 - 2.5
2-11	2-11 1/2	1.5 - 2.5

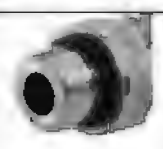

ORB - SAE J1926 Straight Thread Port Assembly Torques													
		Assembly Torque (+10% -0) **If fitting is being torqued into aluminum or brass, subtract 35% from standard torque value**											
		Non-Adjustable				Adjustable				Plugs			
		ORFS		JIC NPT		ORFS		JIC		Hollow Hex		Hex Head	
Dash Size	SAE Size (UN/UNF)	Ft. lbs. (in. lbs.)	Into Alum. Or Brass Ft. lbs. (in. lbs.)	Ft. lbs. (in. lbs.)	Into Alum. Or Brass Ft. lbs. (in. lbs.)	Ft. lbs. (in. lbs.)	Into Alum. Or Brass Ft. lbs. (in. lbs.)	Ft. lbs. (in. lbs.)	Into Alum. Or Brass Ft. lbs. (in. lbs.)	Ft. lbs. (in. lbs.)	Into Alum. Or Brass Ft. lbs. (in. lbs.)	Ft. lbs. (in. lbs.)	Into Alum. Or Brass Ft. lbs. (in. lbs.)
2	5/16-24	-	-	(85)	(55)	-	-	(60)	(39)	(30)	(19.5)	(85)	(55)
3	3/8-24	-	-	(155)	(101)	-	-	(100)	(65)	(55)	(36)	(155)	(101)
4	7/16-20	(310)	(201.5)	(260)	(169)	(180)	(117)	(180)	(117)	(120)	(78)	(260)	(169)
5	1/2-20	(360)	(234)	(280)	(182)	(360)	(234)	(250)	(162.5)	(170)	(110.5)	(280)	(182)
6	9/16-18	(420)	(283)	(350)	(227.5)	(420)	(273)	(350)	(227.5)	(410)	(266.5)	(350)	(175)
8	3/4-16	60	39	(620)	(403)	60	39	(620)	(217)	60	39	(620)	(403)
10	7/8-14	100	65	85	55	100	65	85	55.25	100	65	85	55
12	1 1/16-12	135	88	135	88	135	88	135	88	135	88	135	88
14	1 3/16-12	175	114	175	114	175	114	175	114	175	114	175	114
16	1 5/16-12	200	130	200	130	200	130	200	130	200	130	200	130
20	1 5/8-12	250	162.5	250	162.5	250	162.5	250	162.5	250	162.5	250	162.5
24	1 7/8-12	305	198	305	198	305	198	305	198	305	198	305	198
32	2 1/2-12	375	244	375	244	375	244	375	244	375	244	375	244

HYDRAULIC FITTING TORQUE SPECIFICATIONS

Code 61 and 62 Flange Recommended Bolt Torques

Steps to Properly Assemble the Flange Port Clamping Bolts:

1. Inspect components to ensure that male and female port threads and sealing surfaces are free of burrs, nicks and scratches, or any foreign material.
2. Lubricate the O-ring
3. Position flange and clamp halves
4. Place lock washers on bolts and insert through clamp halves
5. Hand tighten bolts.
6. Torque bolts in diagonal sequence in small increments to the appropriate torque level **refer to the table below.

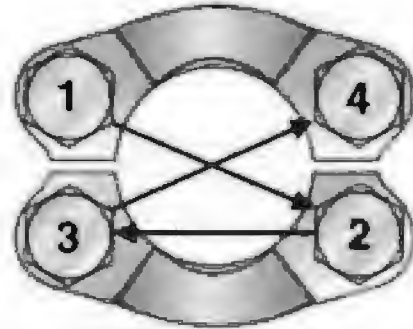

Flange Bolt Tightening Sequence

Code 61						Code 62					
Dash Size	Flange Size	Inch Bolt (SAE J518)	Torque ft. lbs	Metric Bolt (ISO 6162)	Torque N-m	Dash Size	Flange Size	Inch Bolt (SAE J518)	Torque ft. lbs	Metric Bolt (ISO 6162)	Torque N-m
8	1/2	5/16-18	17 ± 2	M8	24	8	1/2	5/16-18	17 ± 2	M8	24
12	3/4	3/8-16	31	M10	50	12	3/4	3/8-16	31	M10	50
16	1	3/8-16	31 ± 4.5	M10	50	16	1	7/16-14	52	M12	92
20	1-1/4	7/16-14	52	M12	92	20	1-1/4	7/16-14	77	M14	130
24	1-1/2	1/2-13	77	M12	92	24	1-1/2	5/8-11	155	M16	210
32	2	1/2-13	77	M12	92	32	2	3/4-10	265	M20	400
40	2-1/2	1/2-13	77	M12	92						
48	3	5/8-11	155	M16	210						
56	3-1/2	5/8-11	155	M16	210						
64	4	5/8-11	155	M16	210						
80	5	5/8-11	155	M16	210						

37° Flare (JIC) Assembly Torques and FFWR					
SAE Dash Size	Thread Size	Assembly Torque (+10%-0)		Tube Connection FFWR	Swivel Nut or Hose Connection FFWR
		In. lb.	ft. lb.		
-2	5/16-24	35	3	-	-
-3	3/8-24	65	5	-	-
-4	7/16-20	155	13	2 1/2	2
-5	1/2-20	165	14	2	2
-6	9/16-18	265	22	2	1 1/2
-8	3/4-16	505	42	2	1 1/2
-10	7/8-14	720	60	1 1/2	1 1/2
-12	1 1/16-12	1000	84	1 1/2	1 1/4
-14	1 3/16-12	1200	100	1 1/2	1 1/4
-16	1 5/16-12	1415	118	1 1/2	1
-20	1 5/8-12	2015	168	1	1
-24	1 7/8-12	2340	195	1	1
-32	2 1/4-12	3180	265	1	1
-40	3-12	-	-	1	1

SET-UP & ASSEMBLY

NOTE: Determine right or left side of the Merger by viewing it from the rear. If instructions or parts lists call for hardened bolts, refer to Cap Screw Torque Values chart.

- Check the Merger for proper assembly and adjustment. Make sure that all bolts are tightened.
- Securely retighten after a few hours of operation as bolts can loosen up on new machinery.
- Lubricate the Merger completely (Refer to the Lubrication section in this Manual).



If the merger was shipped w/o the rims/tire assemblies attached, Attached the rims/ tire assemblies, using the lug nuts furnished. Torque the mounting hardware to the correct torque specification. Check the wheel bolts periodically there after.

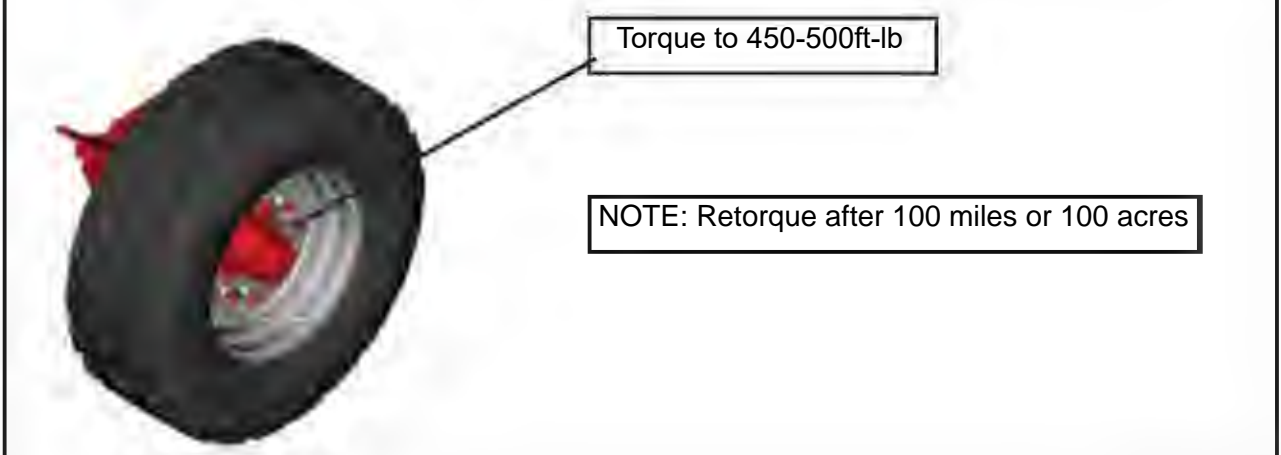

Check tire and inflate to the recommended pressure. (385/65 R22.5)

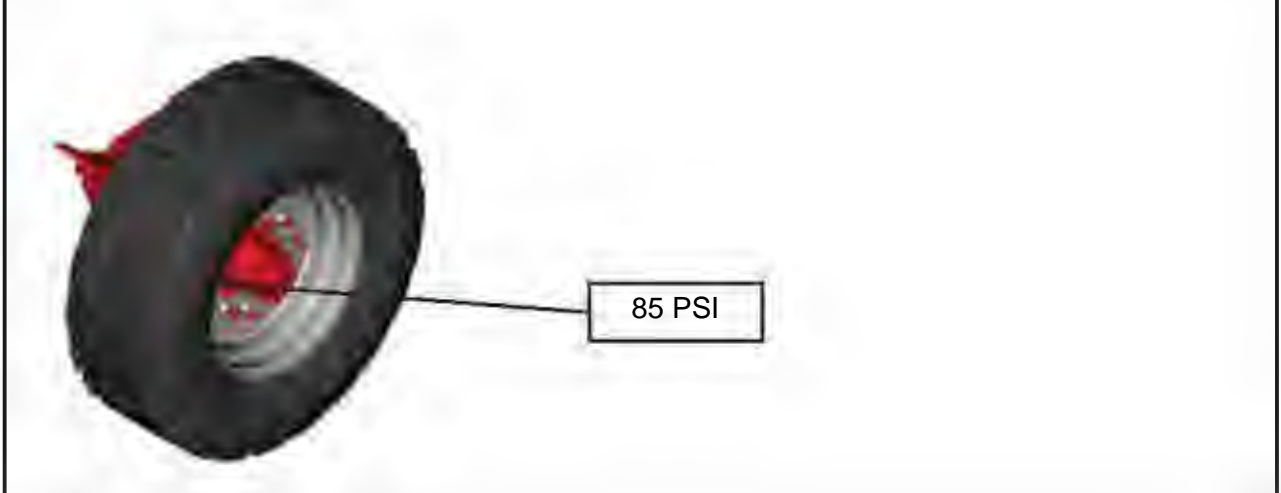

TRANSPORTING

TOWING ON THE HIGHWAY

Follow state and local regulations when towing farm equipment on public highways. Never tow the Windrow Merger on a public highway at a speed greater than 20 m.p.h. (32 kph).

LIGHTS



REFLECTORS

See the decal locations pages for reflective safety decal placements.



MACHINE PREP & OPERATION

TRACTOR REQUIREMENTS

There are several requirements the tractor must have to ensure efficient operation of the Merger.

1. The tractor must be equipped with a 7-pin connector for proper transport and warning light function.
2. The tractor must be equipped with a 1000 RPM 1-3/8" 21 spline or 1-3/4" 20 spline PTO.
3. The tractor must be equipped with a category 2, 3N2 or 3 three point hitch (Quick Hitch would be most desirable).
4. The tractor must also be equipped with a 3-pin convenience outlet that is operated by tractor keyed power or keyed power. Note: optional display harness may come with this, but it is not needed.
5. The Merger requires a minimum 150 H.P. tractor, **AND** that has a minimum tractor weight of 12,000 lbs.
6. Iso Requirements - must have rear facing ISOBUS breakaway.
Auxillary Iso-Bus
Optional Display

MAIN TRACTOR PLUG

1. Black (Ground)
2. Red (Work Lights)
3. Yellow (Left Turn)
4. Not Used
5. Green (Right Turn)
6. Brown (Tail Lights)
7. Not Used

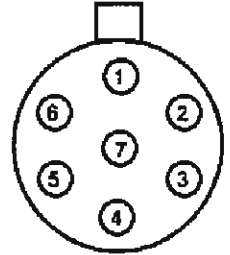

Tractor wiring may differ. Check your tractor manufacturers' electrical diagram to match to the Merger's wiring.

ISOBUS

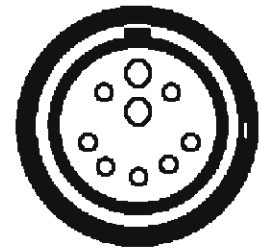

TRACTOR HOOK UP

3-Point

Raise the 3-point hitch just until the jack stand can be swung into the transport position, the 3-point is now at the proper operating height. Correct hitch distance from ground to center of pins is 24" to 26". If the tractor is equipped with a quick coupler make sure the latches are engaged.

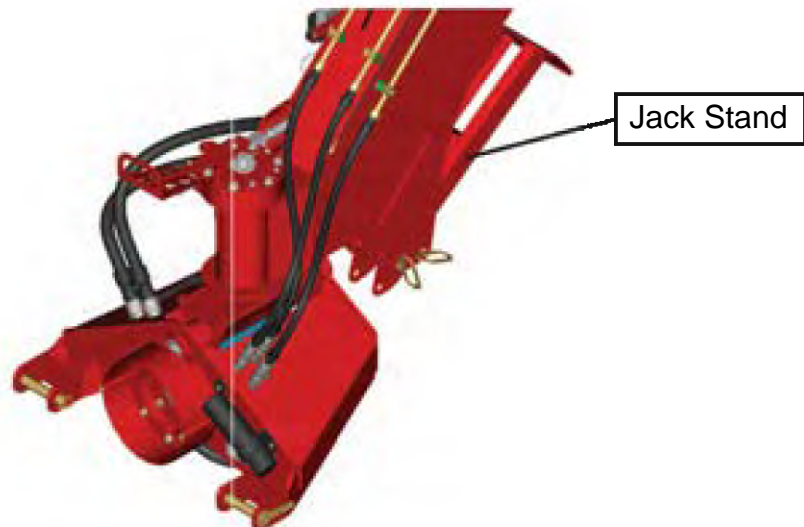

MACHINE PREP & OPERATION

PTO

- The PTO is a direct drive system to the pump.
- Configure the proper PTO length and spline needed for the tractor. Using the two set screws supplied with PTO, connect the PTO shaft to the pump input shaft. The top PTO shield swings back with removal of driver side pin for easy access to PTO set screws. Replace the PTO shield before using the machine.
- Slide the spring loaded locking collar on the PTO yoke rearward and slide the yoke onto the tractor PTO shaft. Release spring loaded collar. Be sure the pins fall into the groove on the tractor PTO shaft and collar snaps forward into position. **CAUTION:** Do not use a steel hammer to aid in joining PTO parts.



**PTO operating speed may vary from from 700 to 1000 RPM
depending on the crop that is being merged**

WARNING: DO NOT RUN THE CROSS-CONVEYOR BELTS WHEN THE *TWIN-FLEX* MERGER IS IN THE TRANSPORT POSITION AS DAMAGE WILL OCCUR WHEN THE BELTS ARE RUN OFF OF CENTER!

Folding and Unfolding

When unfolding and folding up the merger heads the **PTO** speed has to be at **500 RPM**. It is critically important as well that an operator knows how to correctly fold up the merger as well otherwise damage will occur to the pole hard lines.

Steering Settings

Place a ½” bolt thru the pole hitch location directly over the hitch pivot hole at the very front of the merger to verify center at the hitch. Place the calibration tool into the correct service port (5) on the left head module. Then Center the steering rack in the rear. Remove calibration tool which now zeroed the steering sensors and put in the parts book holder. Remove the wires from SV3 and SV4 coils to prevent the computer from compensating the system. Pull the merger outside in the stored position with the PTO on to activate the steering and start making some turns left and right. This will take some time before the air will work its way out of the system. If dog tracking make adjustments to the master cylinder in the front to get the steering to return back to center after a turn. Make 2-1/2 turn into the steering rack from the starting point to get the merger to “center” after a full turn, Lock the jam nut at the master/rack position. Hook CV3 and CV4 back up. Manually override the CV3 valve making the rear axle turn. The axle should at some point stop turning and then return back to center +/- 1/8.” If the axle continues to move all the way to lock, swap CV3 and CV4 wires and repeat test.

MACHINE PREP & OPERATION

Electrical

Fuse Block 1 (Top)

Position #1 - 15 amp
Position #3 - 15 amp
Position #5 - 5 amp
Position #6 - 5 amp

Fuse Block 2 (Top)

Position #1 - 15 amp
Position #3 - 15 amp
Position #5 - 15 amp

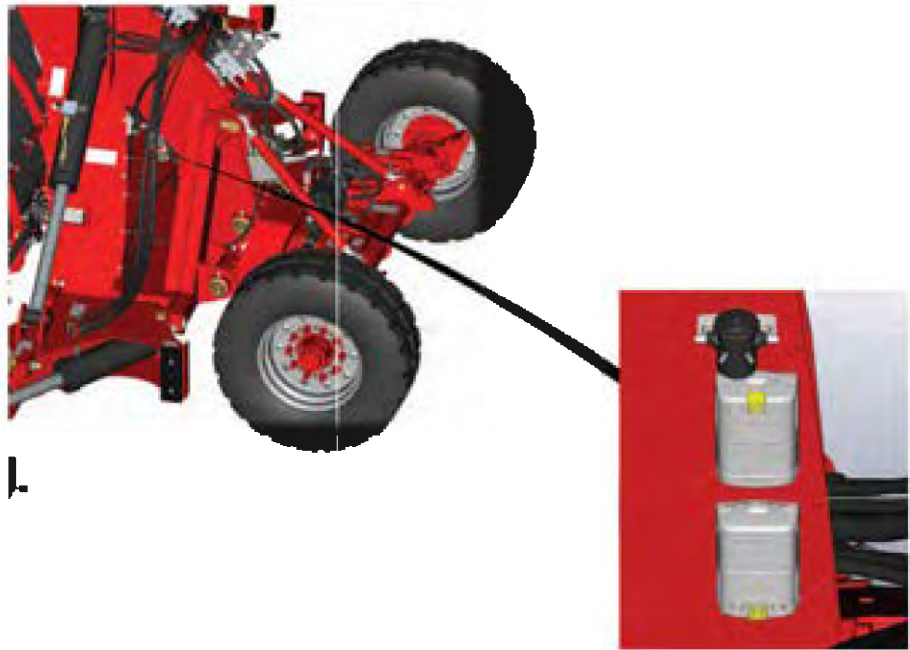

SOFT SHOE™ SUSPENSION SYSTEM

The H&S **SOFT SHOE™** Suspension System is a self-contained hydraulic suspension system that provides the softest merger head footprint in the industry! This is important in many field conditions...wet soils, rough terrain, new seeding, etc.

The **SOFT SHOE™** Suspension System incorporates an additional pump section to the PTO pump assembly, along with computer-controlled logic that self-regulates the nitrogen-charged accumulator head suspension system pressure. The operator controls the desired head suspension system pressure from the remotely-mounted display console. Excess oil from the pump is diverted back to tank through the solenoid manifold assembly. When operator chooses to increase the head suspension system pressure, this reduces the skid shoe weight in the field. Oil is diverted from the accumulator to the two head lift cylinders to "lift" the heads thereby decreasing the amount of weight on the skid shoes. If the operator chooses to decrease the head suspension system pressure, this has the effect of adding skid shoe weight in the field. When this happens, oil is "bled" from the two head lift cylinders which increases the weight of the heads on the skid shoes.

As the merger is operating through the field, the H&S **SOFT SHOE™** Suspension System provides a self-regulating feature that constantly adjusts the weight on the skid shoes. This is accomplished with the computer-controlled logic that constantly senses the hydraulic pressure fluctuations that come with the constant changes in field environments, especially rolling and rough ground conditions. The computer-controlled logic send signals to control manifold solenoids and can do so at a rate of up to 125 signals per second.

What you end up with is a self-monitoring weight transfer system that maintains a constant system pressure throughout the entire 20" of header travel. The H&S **SOFT SHOE™** Suspension System delivers a footprint that reduces field damage from head scuffing and minimizes wear on the skid shoes.

ISO-BUS DISPLAY



- ← Belts ON and OFF
- ← Right Direction
- ← Left Direction
- ← Spilt Belts

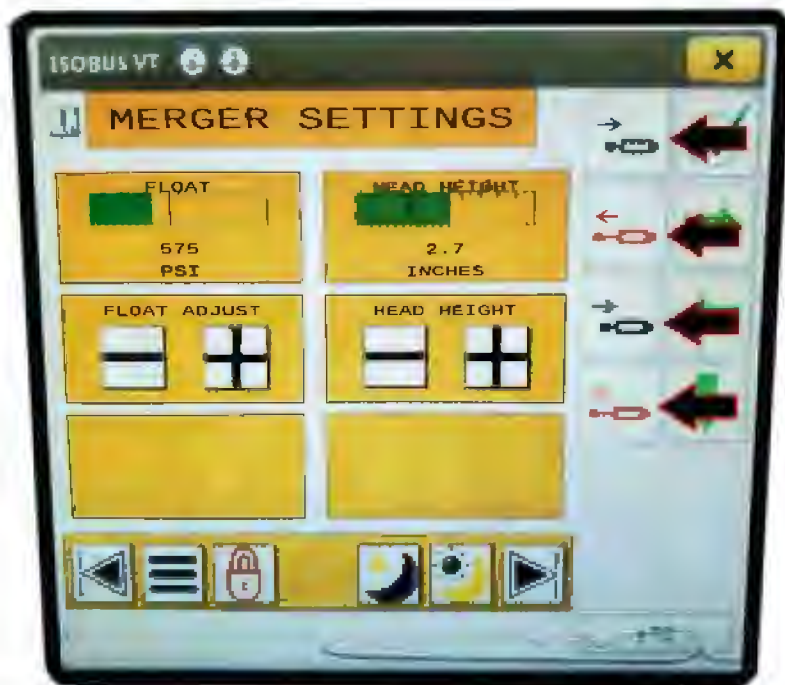

- ← Right head up
- ← Right head down
- ← Left head up
- ← Left head down

ISO-BUS DISPLAY



The Black Lines on the Float Is the Target Pressure. The Black Line On The Height Does Not Move, The Green Bar Should Be Above The Black Line.

Full Pressure Right head



Right Pickup Reel



Right Belt Pressure



ISO-BUS DISPLAY

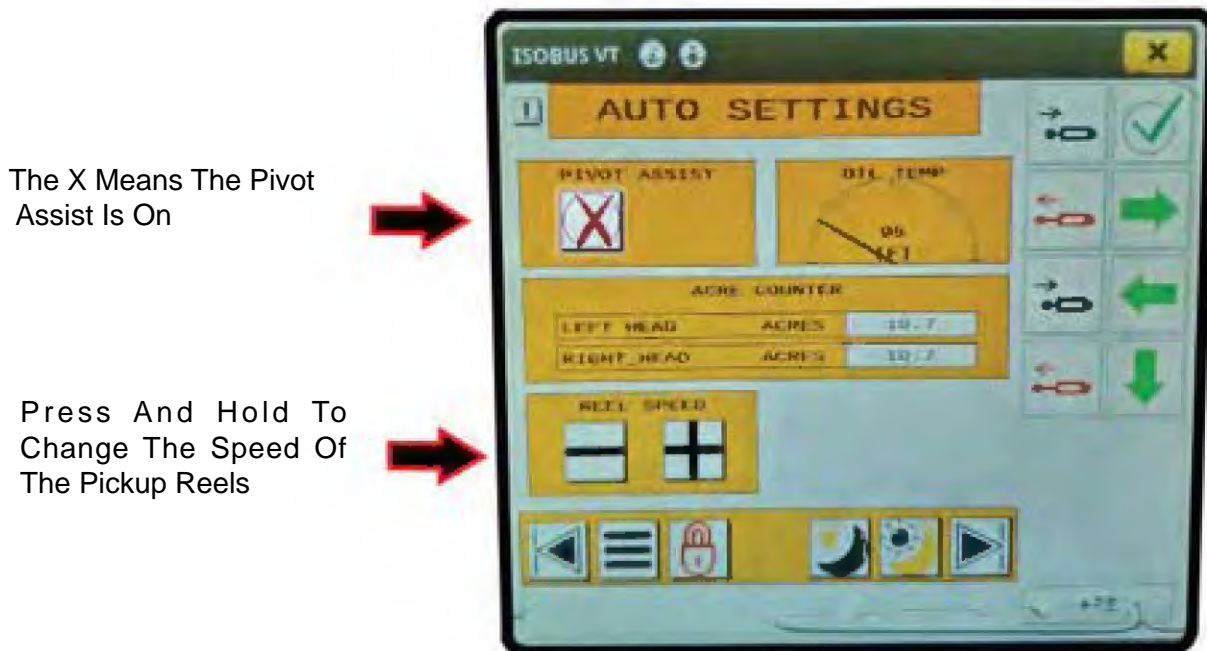
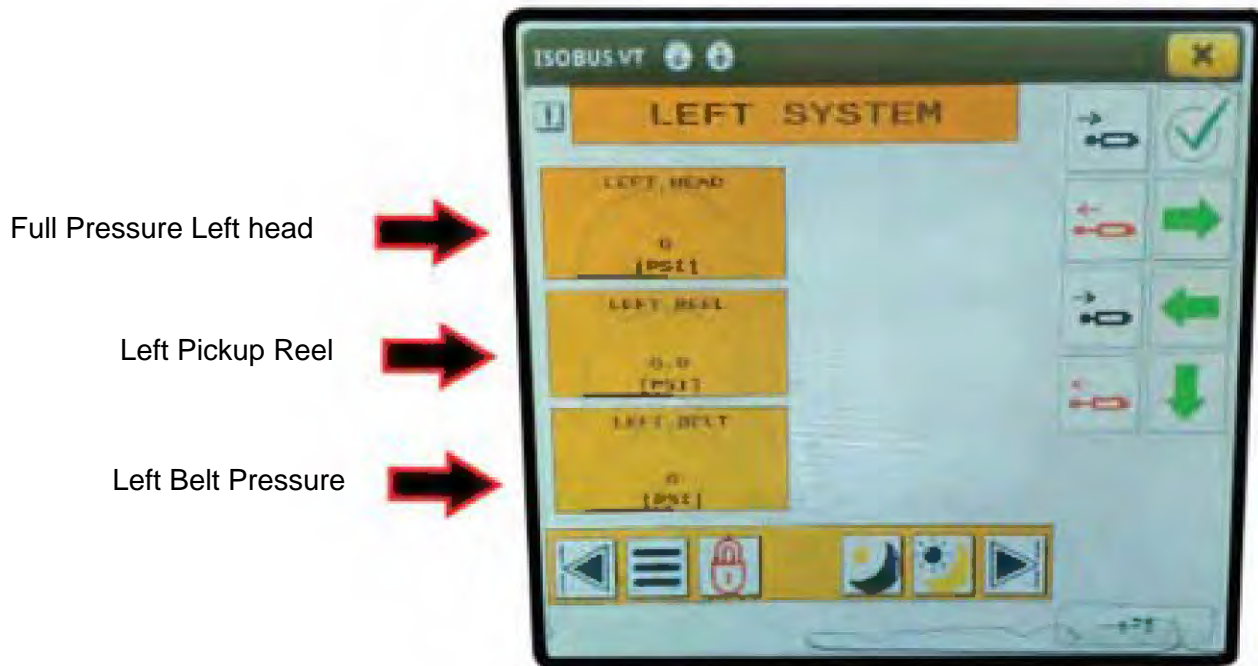

One Touch Of The Head Button Will Raise Right Or Left Head To Get Over The Window

CAN-BUS DISPLAY

Display when start-up of CAN-BUS



CAN-BUS DISPLAY



Belts RIGHT



Belts LEFT

CAN-BUS DISPLAY



Belts discharge to left and right.



Head Height UP and DOWN

CAN-BUS DISPLAY

Right Head folding UP



Need to hold bottom button for 4 seconds when folding up



Right Head folding DOWN



HOLD BUTTON FOR
FOR FOLD TO STORAGE

CAN-BUS DISPLAY

Left Head folding **UP**

Need to hold bottom button for 4 seconds when folding up



Left Head folding **DOWN**



CAN-BUS DISPLAY



NOTE: When folding the heads up hold both buttons, release the bottom button after 4 seconds, keep holding the top button till the heads are up.



NOTE: If you run too much float pressure the head may not drop to the ground when unfolding.

If you run not enough float pressure the heads could have a gap in between and could leave hay.

CAN-BUS DISPLAY

Diagnostic's



ADJUSTMENTS

ACCUMULATOR

Releasing Accumulator Pressure

WARNING!

When making adjustments, the machine will see the new parameter and adjust the machine appropriately. This may cause the machine to move in the direction of the new parameter.

- **Ensure that everyone is clear of the machine when making adjustments.**
- **Ensure that everyone is clear when working on, operating, or moving the Merger.**
- **When working on high pressure hydraulic circuits, the oil can be under pressure and cut through the skin.**

WARNING!

PRESSURE MUST BE BLED FROM THE ACCUMULATOR BEFORE REPAIRING OR REMOVING IT.

1. Remove the **VALVE GUARD & VALVE CAP** as shown in the first picture below.
2. Attach the **GAUGE** to the **VALVE STEM** and turn in the **VALVE THUMB SCREW** to bleed the pressure from the **ACCUMULATOR** as shown in the second picture below.

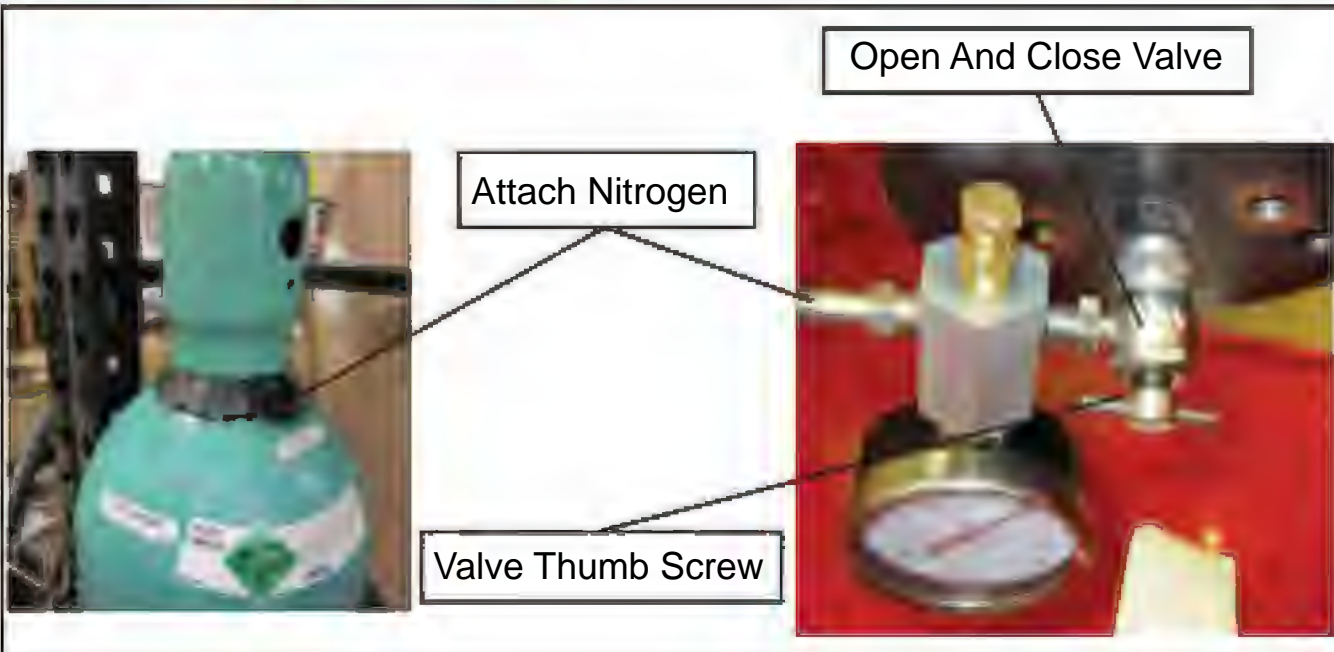
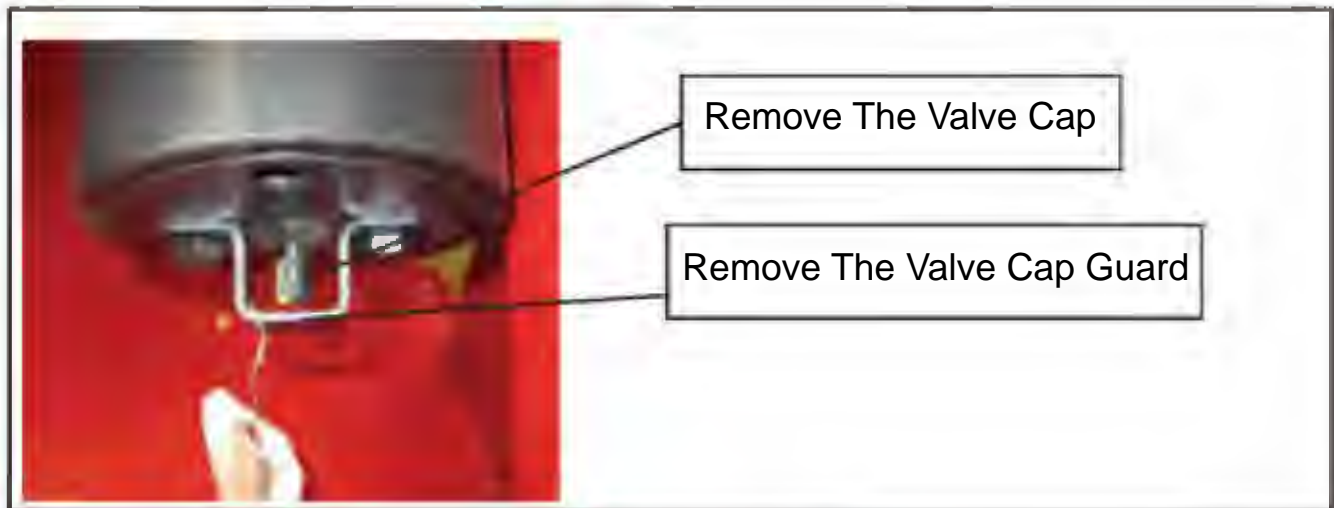

ADJUSTMENTS

To recharge **ACCUMULATOR(S) By A Qualified Professional Or Dealer**, remove **VALVE GUARD** and **VALVE CAP**. Attach Gauge to VALVE STEM (make sure the Valve Thumb Screw is turned out all the way (closed) before attaching). Connect Nitrogen Tank to Gauge inlet. Turn in the Valve Thumb Screw on the Gauge to open the Valve. Open the Valve on the Nitrogen tank to fill the **ACCUMULATOR(S)** to the pressure to 350PSI. Close the Nitrogen Tank Valve and turn the Gauge Valve Thumb Screw all the way out to close it then disconnect the Nitrogen Tank and the Gauge.

Make sure to reattach the valve guard and valve cap.

ADJUSTMENTS

PICKUP SPEED

The pick up speed is adjustable using the manifold on the back of each head. In light crops an operator can slow the pick up speed down while maintaining belt speed. (note lowering PTO rpm will slow both the belt and the pick up reel). Pickup speed may also be adjusted on the touch screen in the cab.

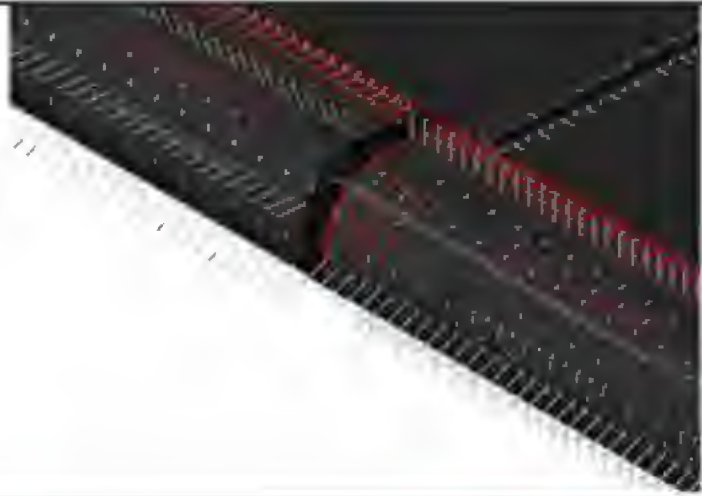

CROSS CONVEYOR SPEED

The cross conveyor speed on the Merger can only be changed by varying the tractor PTO speed. The speed relationship between the pickup and the cross conveyor is preset for an all around optimum performance level.



CROSS CONVEYOR BELT ADJUSTMENT

NOTE: Cross conveyor belts should be checked for correct tracking frequently in the first 300 acres, then daily thereafter.

To adjust belt tracking;

1. Slightly loosen the 4 bolts (A).
2. Adjust the jam nuts either way to set the belt tracking (B).
3. Tighten the 4 bolts (A) after the belt tracking is set.

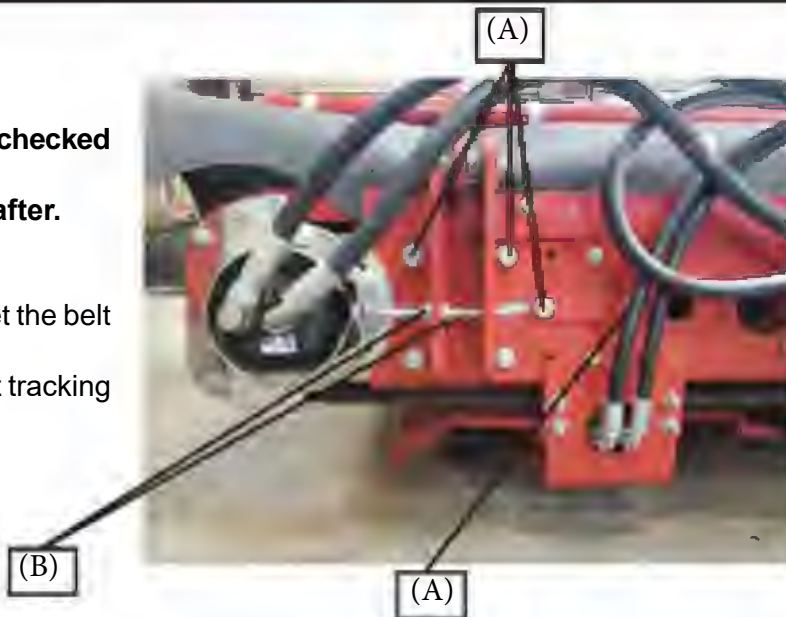

ADJUSTMENTS

The center adjustments are set at 2 7/8" to square up the center roller.

The outer adjustment starts at 2 7/8", then it is moved to adjust belt tracking. If the belt is tracking rearward, the roller needs to be adjusted out. If the belt is tracking forward, the roller needs to be moved in.

It is easier to adjust one belt at a time with the opposite head in the transport position. When a belt is tracking properly, the center groove will ride in the notch in the roller and the belt will have an audible hum/buzz to it. Be sure to run the belt in both directions to ensure proper tracking.

The following procedure is to ensure that the belt is tracking properly and stays centered on the roller.

MAKE SURE EVERYONE STAYS WELL CLEAR OF THE MACHINE WHEN PERFORMING THIS PROCEDURE.

Ensure that the oil is warmed up and the PTO is running at 1000 RPM. With the belt running, lift the head up until the deflector goes down. This will cause the belt to ride toward the back of the head. Only allow the belt to run like this for a minimal time to ensure that major damage does not occur to the belt edge. Then, lower the head back to the ground. In minimal time (30 seconds or less), the belt should track back to the center of the roller. If this cannot be accomplished, further belt adjustments need to be made.

If the belt tracks significantly different when the belt direction is changed, it is likely that the set screws on one or both of the rollers are not holding properly. Split the belt and locate the 2 set screws as show in Figure 42. Remove the set screw. With the roller and spacer tight to the locking collar, ensure that the shaft is dimpled in the location where the set screw is tightened. Reinstall the set screws with locking compound.

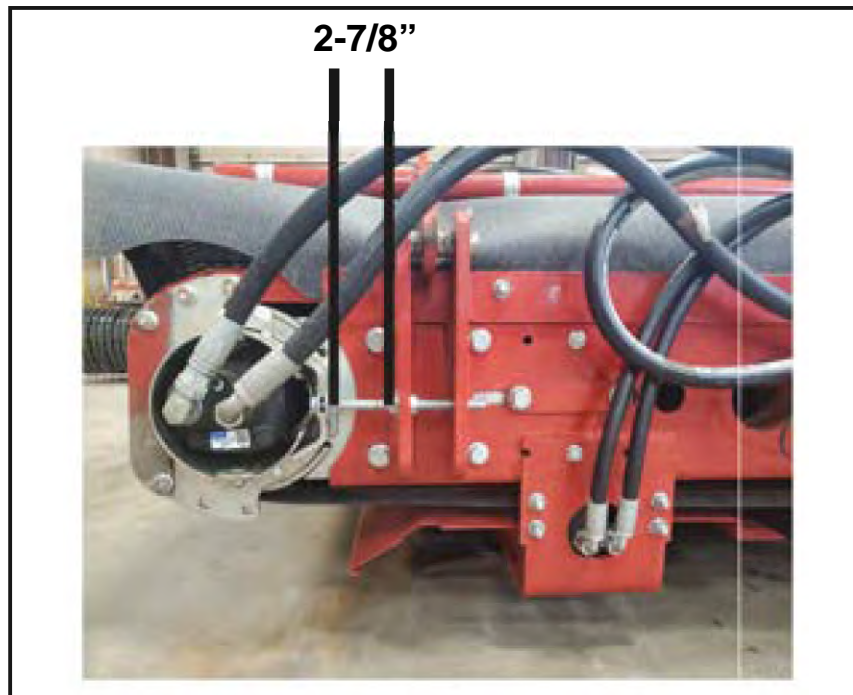

SERVICE

DAILY SERVICE

Cleaning

It is a good practice to clean the entire merger at the end of each day. Getting the chaff and crop off the merger when dry will save the appearance and finish of the merger. It also gives the operator a chance to check the machine up close to keep it operating properly. Before starting to merge each day, make sure to check for crop build-up under the cross conveyor belts and cross conveyor rollers. This is easily accomplished while the merger is in the transport position. If there is build-up it must be removed prior to operation or it could cause cross conveyor belt failure. The best way to do this is with forced air pressure.

Skid Shoes

Clean out the skid shoes at least once a day when the merger is in the transport position. They can become packed with debris and dirt during normal operation. Cleaning is very important for proper skid shoe operation.



Pickups & Hay Strippers

Check the pickup teeth and hay strippers daily that none were broken or damaged by field obstructions to ensure proper field performance.



Oil Fill & Check Plugs

Check the oil level daily by the "Cold Level Check Plug". If oil cannot be seen at the Cold Level, remove the hydraulic oil fill cap and add oil until oil begins coming out of the cold level check. Note the cap vents at 5 psi so there may be some air pressure when removing the cap.

Note: Belts will shut off when max hot oil of 220 is reached.

120 or higher, check hot fill, 120 or below check cold level..

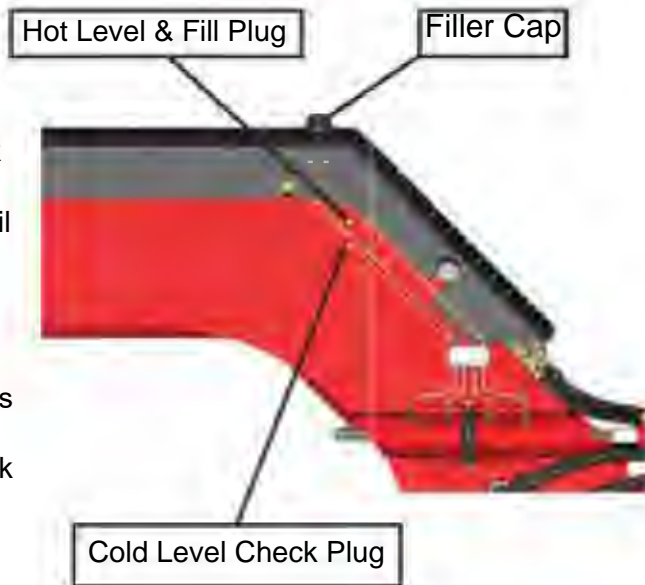

SERVICE

ANNUAL SERVICE

Cam Bearings

Depending on the acres per year, and field conditions, the cam bearing should be inspected annually for wear and replaced when the outer bearing surface no longer has a taper and has become flat. Cam bearing can be replaced with out removing the the tine bar by using the access port designed into the center drive gearbox.

Wear Bearing



New Bearing



Tine Bar Bearing

Tine bar bearings should be inspected annually for wear and replace when there is 3/16" of up and down movement on the tine bar. The 2 piece design of the tine bar baring allows them to be easily changes with out removing the tine bar.



Cross Conveyor Belts

The cross conveyor belts should all be removed at the end of each season and the inner frame work thoroughly cleaned of build-up and debris. This will ensure proper operation the next season.



SERVICE

ANNUAL SERVICE

Oil Filter

The hydraulic oil filter should be changed at least once a year or prior if filter becomes clogged during the season.

To change the filter; remove fill cap and then:

1. Unscrew the filter cover. Located on the of the tank
2. Carefully remove & discard the used filter cartridge.
3. Insert the new oil filter cartridge.
4. Replace filter cover.

Head GearBoxes

Each pickup is powered by a gearbox in the center of the head.

Each center cam gearbox uses 26 ounces of SAE 30W motor oil. The oil in each gearbox should be checked before each crop and changed on an annual basis.

Oil is drained by removing the lower cover. This is accomplished by removing the 4 bolts (A).

When reinstalling cover, inspect the O-ring (PN 82330) for damage and replace as necessary. Ensure that the O-ring is properly seated in its groove when replacing the cover.

Add oil and check at the fill plug (B)

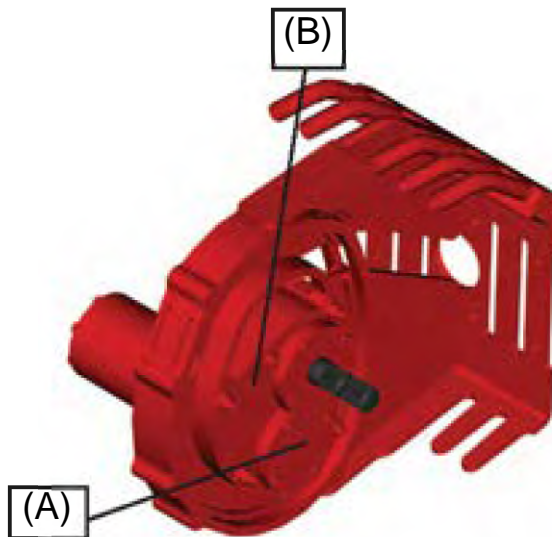

Belt Tracking:

See Service Manual

OPERATING WITHOUT ELECTRONICS

Your twin-flex merger is designed to operate without any electronics. In the event that an electrical issue occurs simply unplug the main battery harness between the merger and the tractor. Both belts will default to the right. The merger will still have flotation but it will not be active flotation with the Soft shoe. To manually adjust the flotation without electronics:

With the PTO on and the heads in the working position, pushing in on valve (A) will add pressure to the accumulator. Using a key ring to pull on valve (B) will remove pressure from the accumulator.

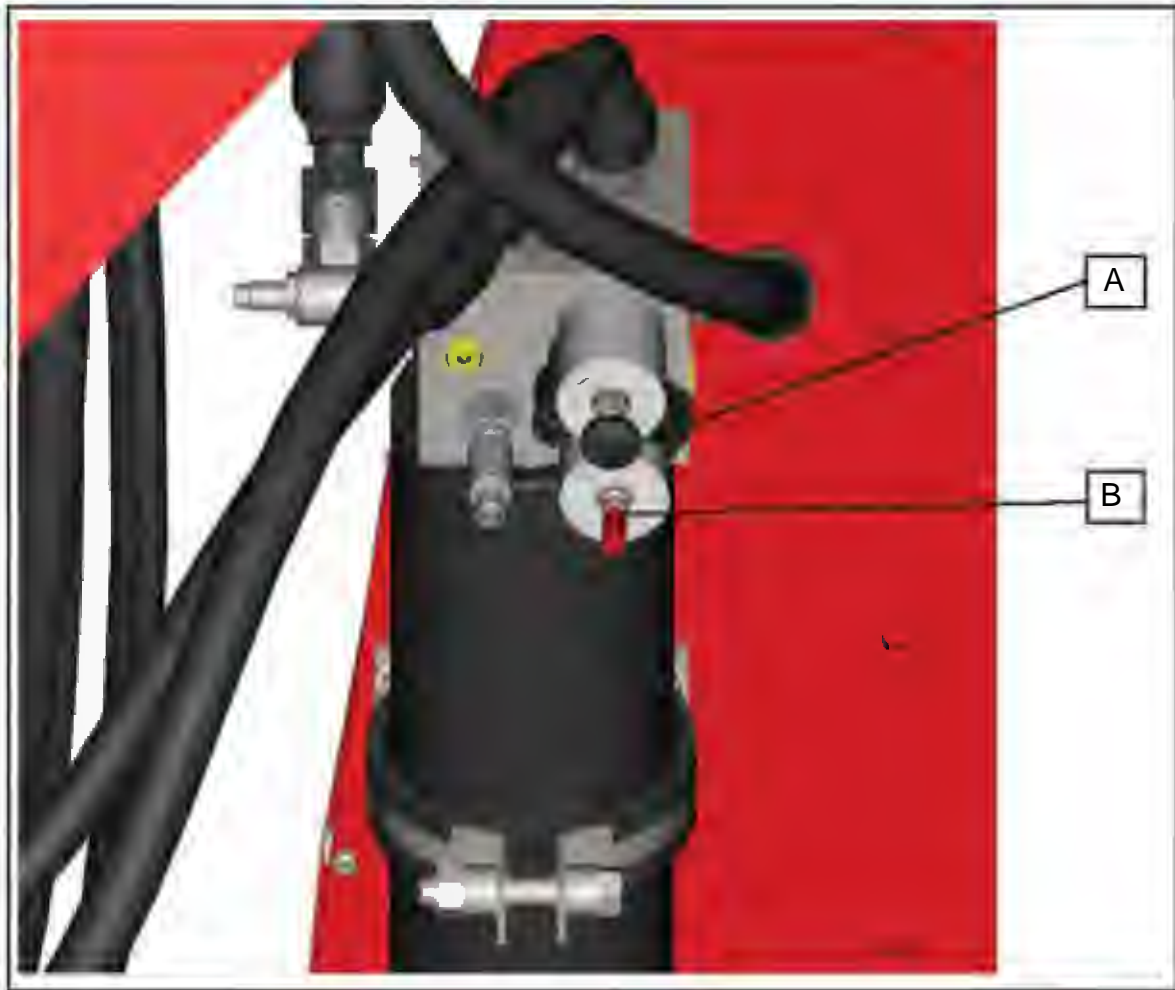

OPTIONS

TFOICC IN CAB DISPLAY

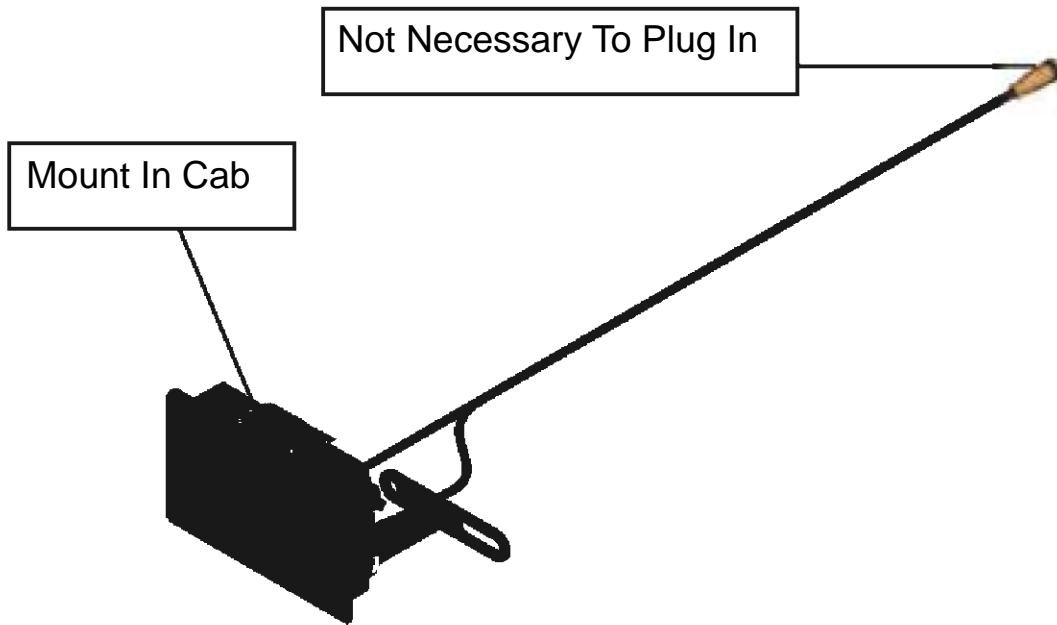

LUBRICATION

GENERAL INFORMATION

IMPORTANT: *Catch and dispose of fluid per local waste disposal regulations whenever service is performed on hydraulic components (valves, cylinders, hoses, etc.) or transmission.*

There are numerous grease fittings on your merger. If these are lubricated properly and often enough, it will prolong the life of the merger. Grease daily during normal use and **before and after storage and after power washing.** Use high-quality grease. Make sure grease comes out around the shaft on the sleeve type bearings. On the sealed ball bearings, grease should be added slowly until a slight bead forms at the seals indicating the correct amount of lubricant. Wipe off excess grease to prevent accumulation of grit around the bearings.

For the center cam gearboxes, use SAE30W motor oil. The gearboxes hold 26 ounces of oil.

The tongue reservoir holds 65 gallons of ISO 46 hydraulic oil.

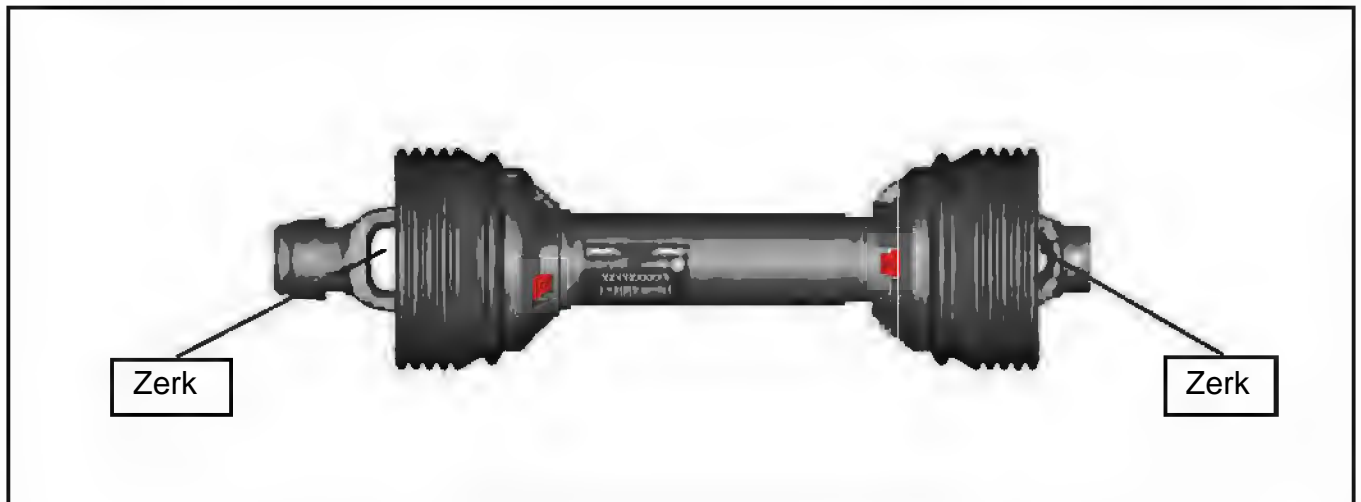

LUBRICATION

One on each wheel hub (80/90 Gear Oil)

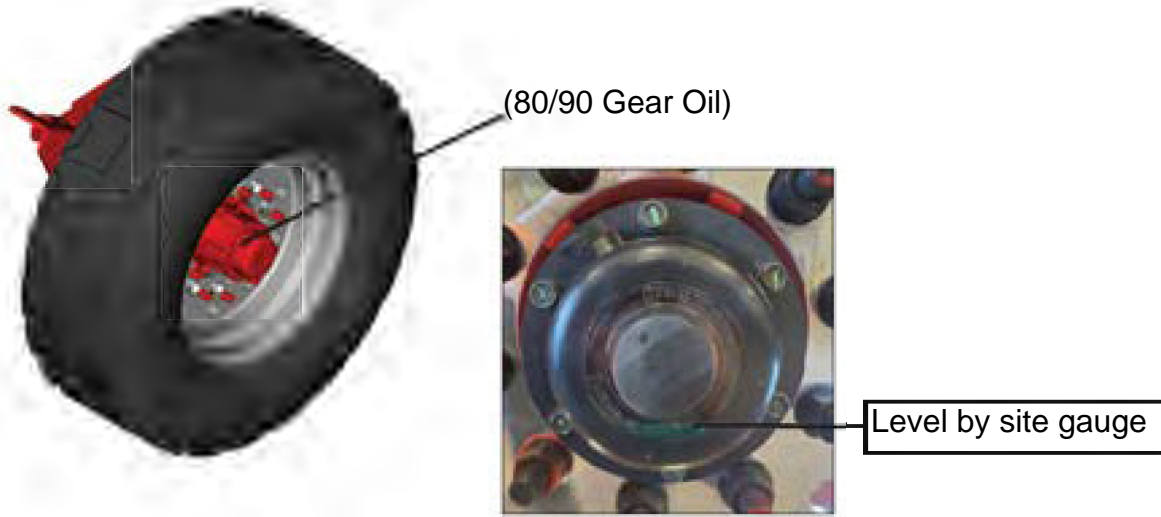

One on each end of each pickup head.

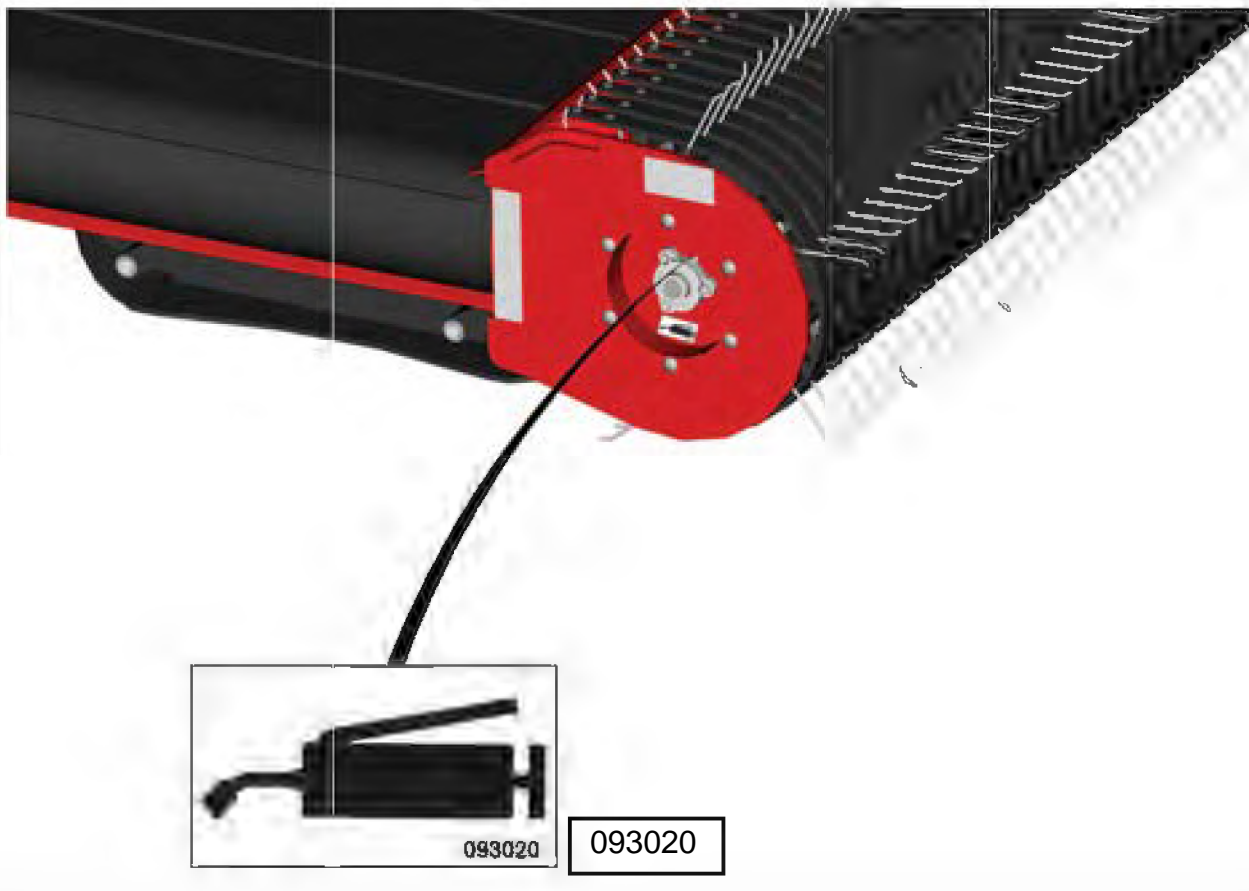

LUBRICATION

One on each head pivot. Grease every 40 hours.

Right Head

Left Head



093020

093020



Grease Annually

093020

093020

LUBRICATION

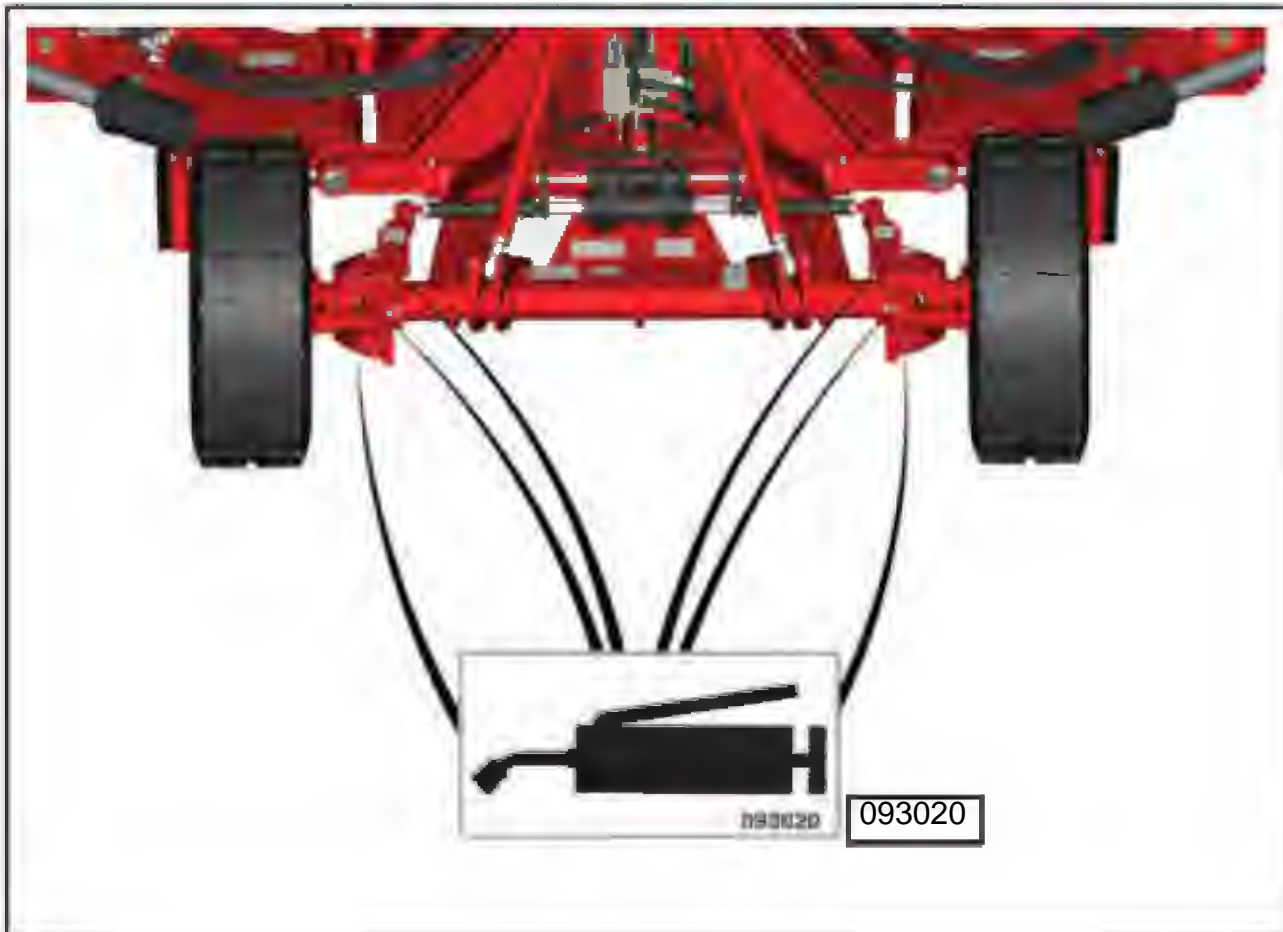
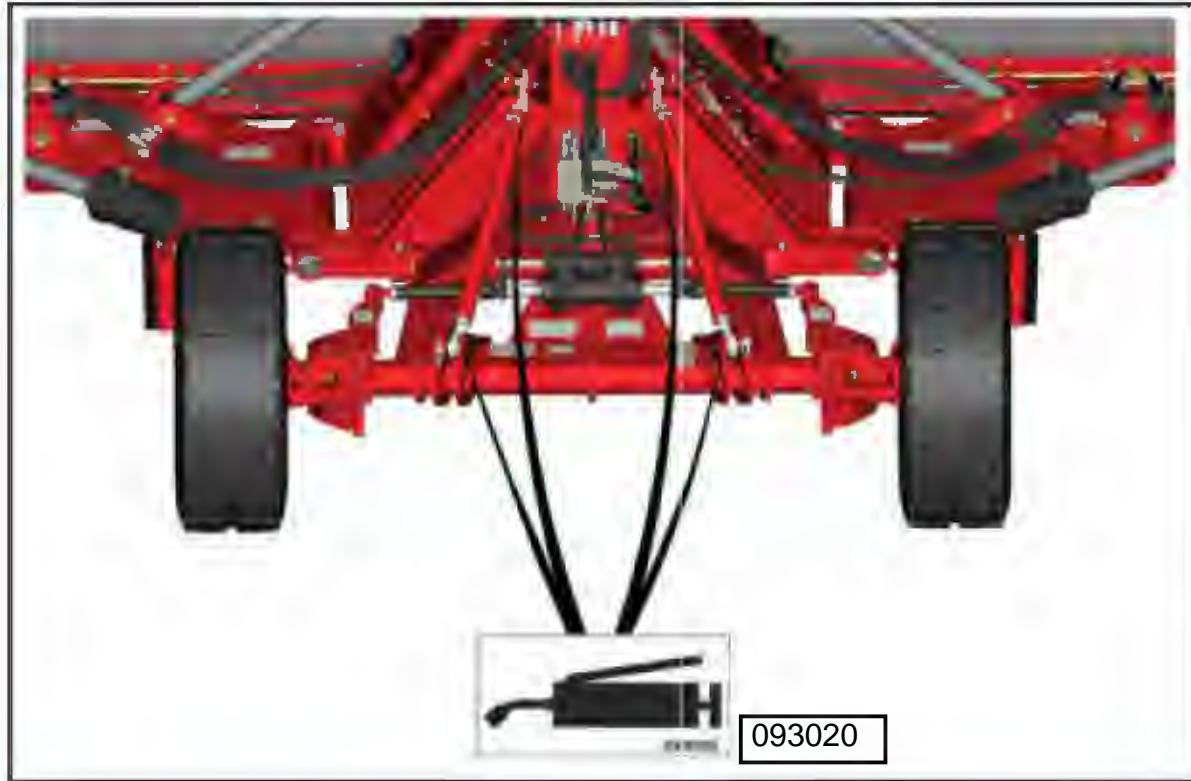

LUBRICATION



LUBRICATION

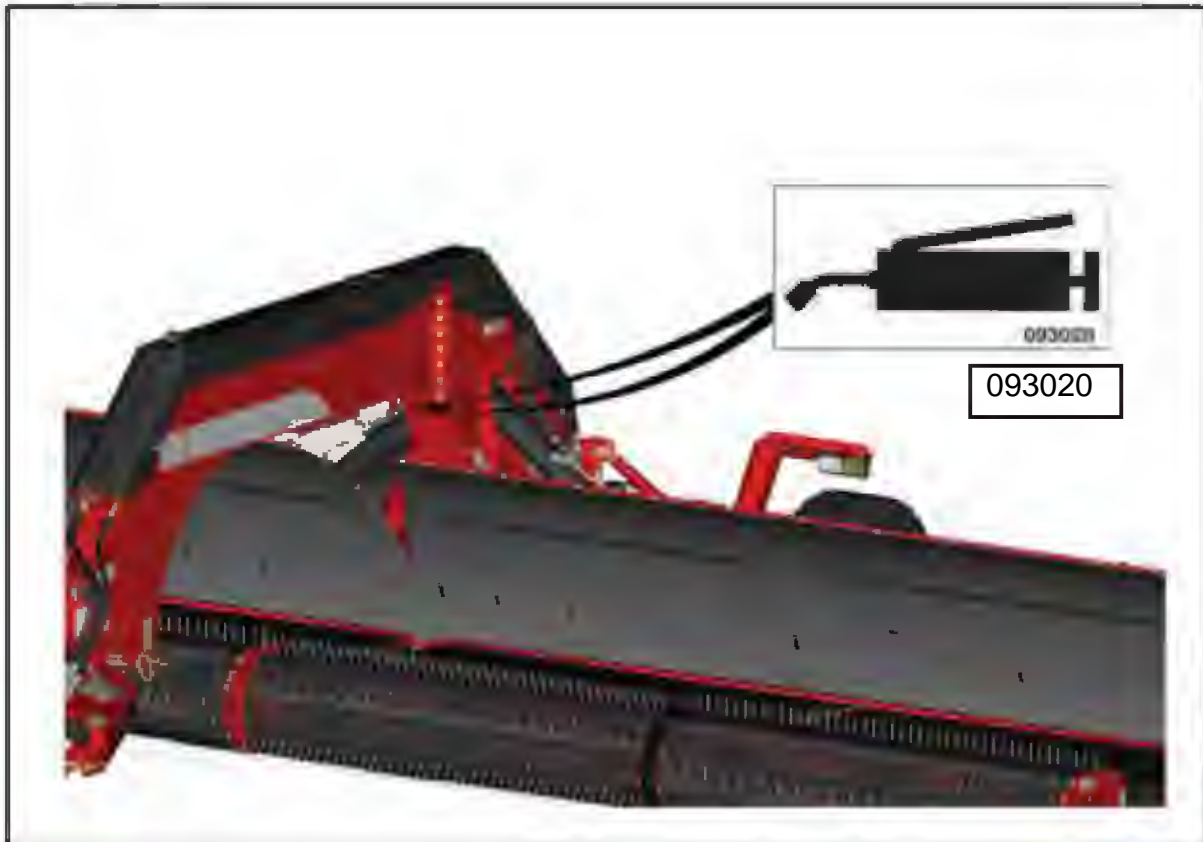
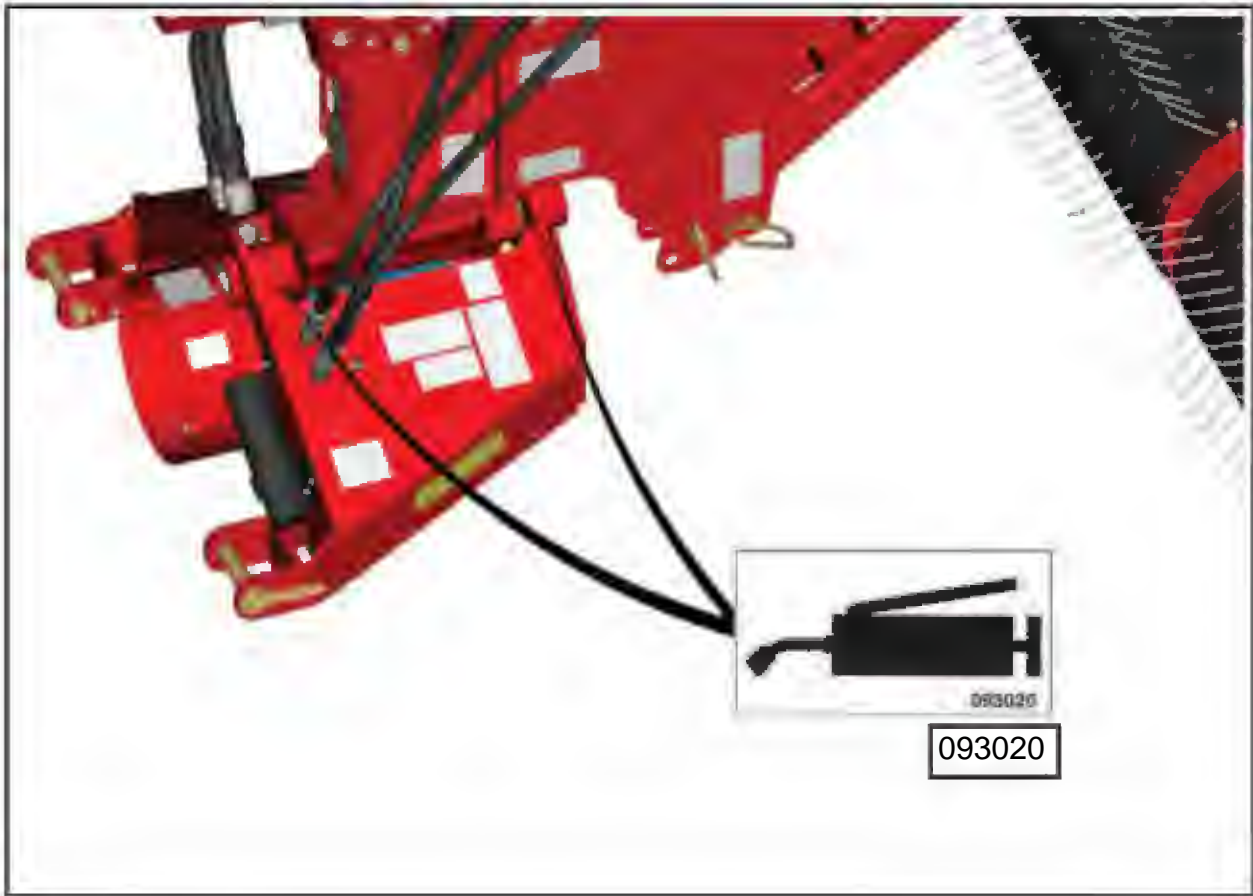

LUBRICATION

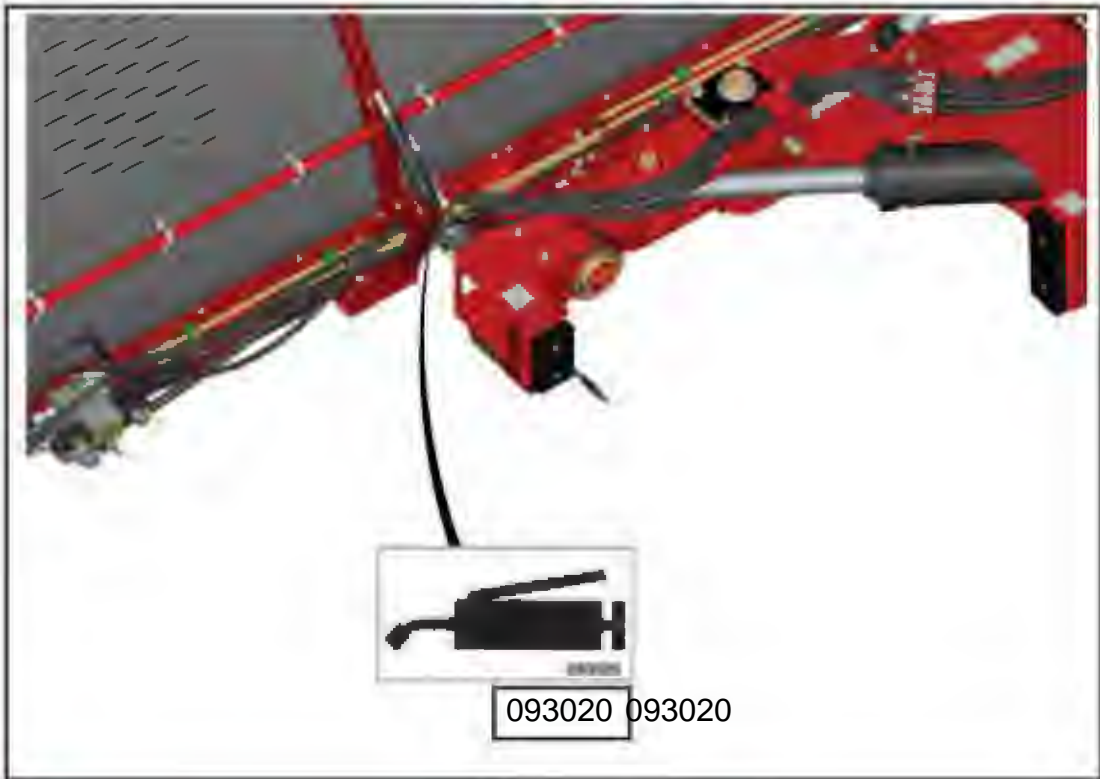

DECAL LOCATION

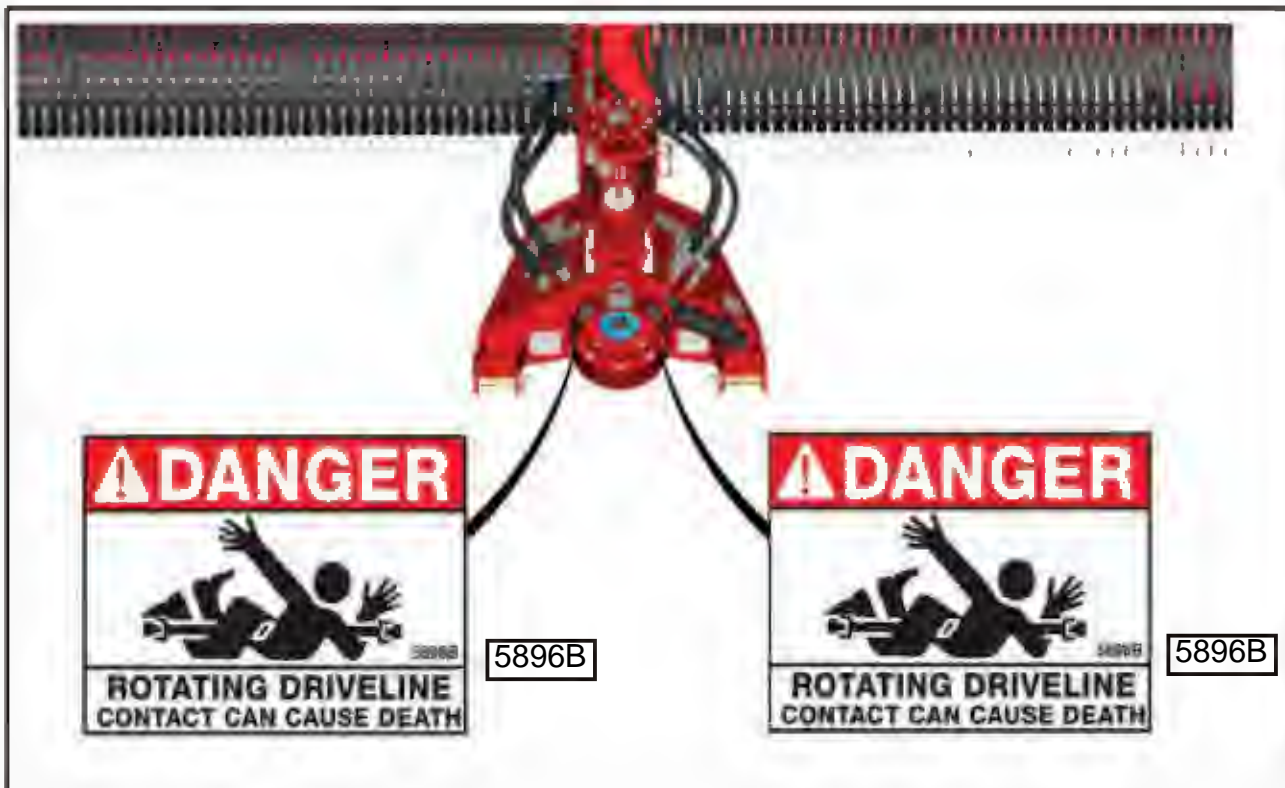

DECAL LOCATION

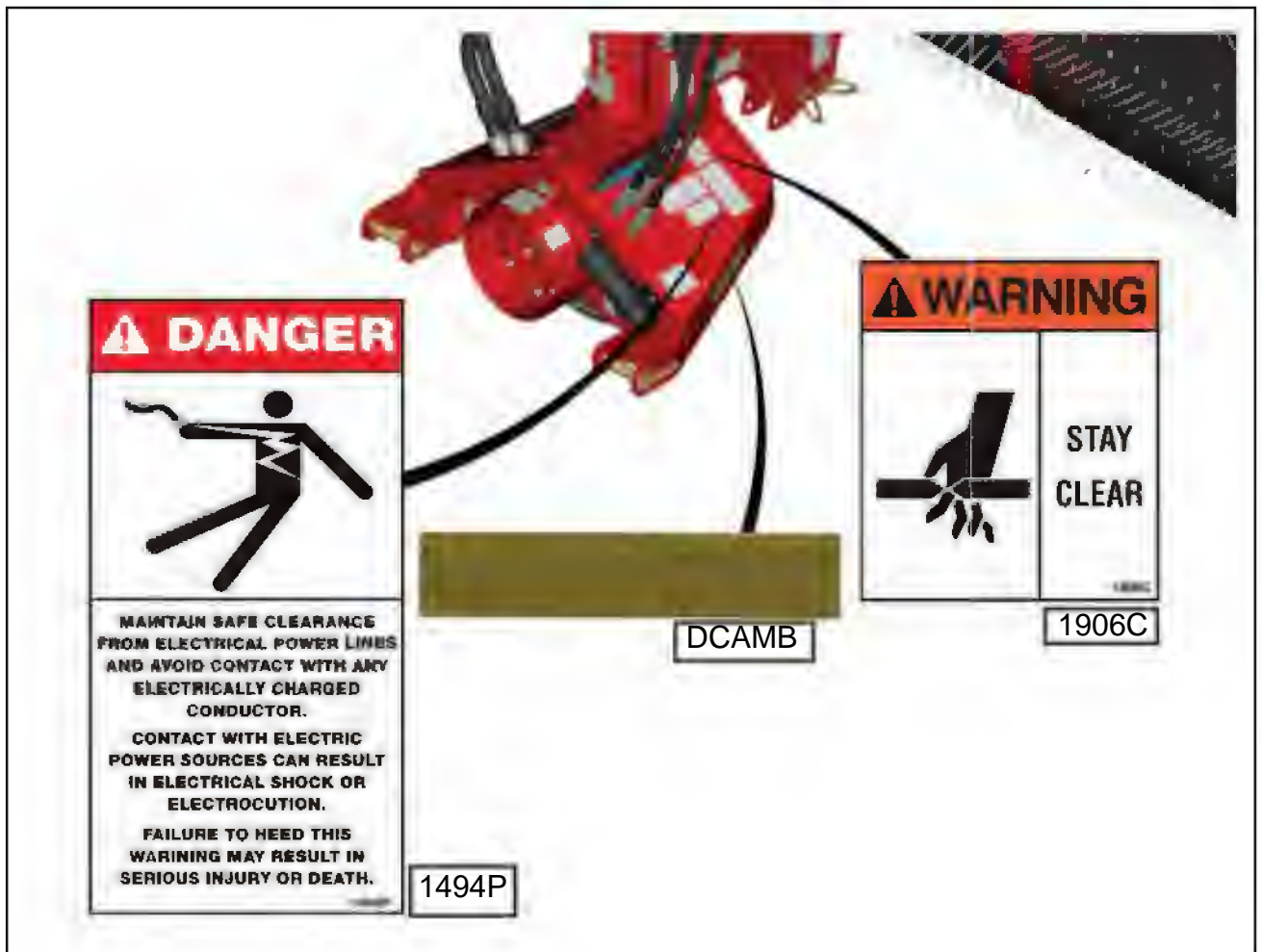

DECAL LOCATION

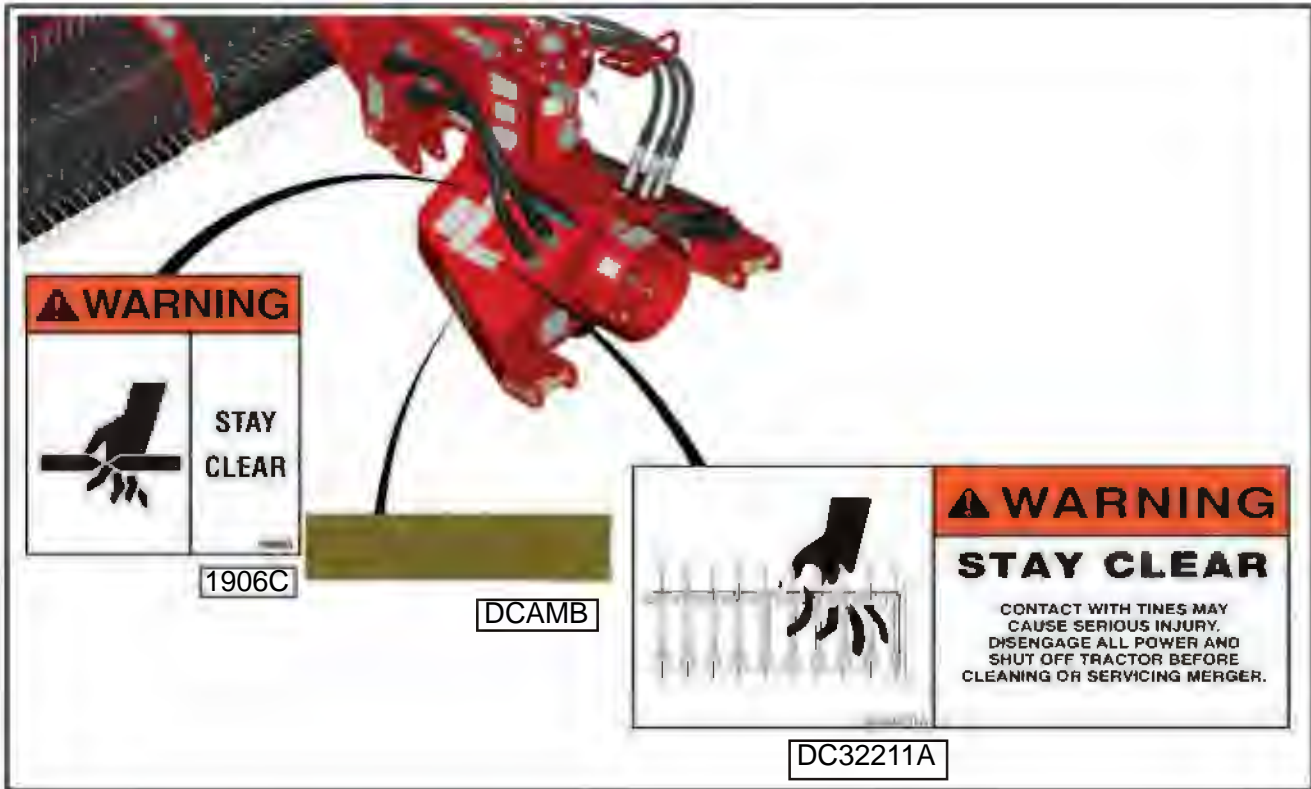

DECAL LOCATION

WARNING

DO NOT GO NEAR LEAKS

- High pressure oil easily punctures skin causing serious injury, gangrene or death.
- If injured, seek emergency medical help. Immediate surgery is required to remove oil.
- Do not use finger or skin to check for leaks.
- Lower load or relieve hydraulic pressure before loosening fittings.

11599

DANGER

STAY CLEAR OF MOVING PARTS

FAILURE TO HEED THIS WARNING MAY RESULT IN PERSONAL INJURY OR DEATH

KEEP CLOTHING, YOURSELF AND OTHERS WELL CLEAR

73101

11599

DANGER

NEVER ALLOW RIDERS ON THIS MACHINE

82907L

WARNING

SLAG GENERATED BY HEATING OR CUTTING NEAR PRESSURIZED FLUID LINES CAN PUNCTURE LINES RESULTING IN SEVERE INJURY. NEVER WELD OR CUT ON HYDRAULIC RESERVOIR OR FRAME WORK USED AS A RESERVOIR.

DC32211B

DECAL LOCATION

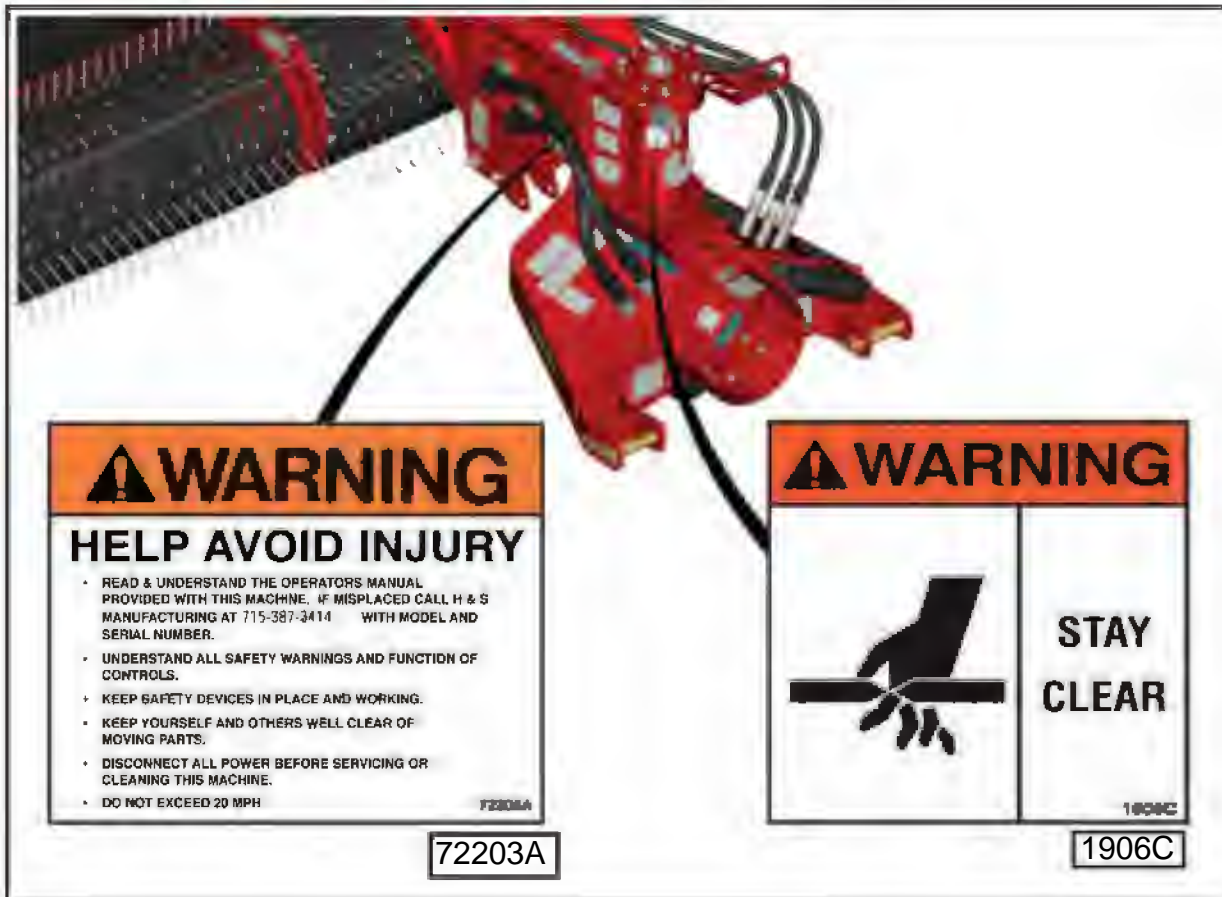
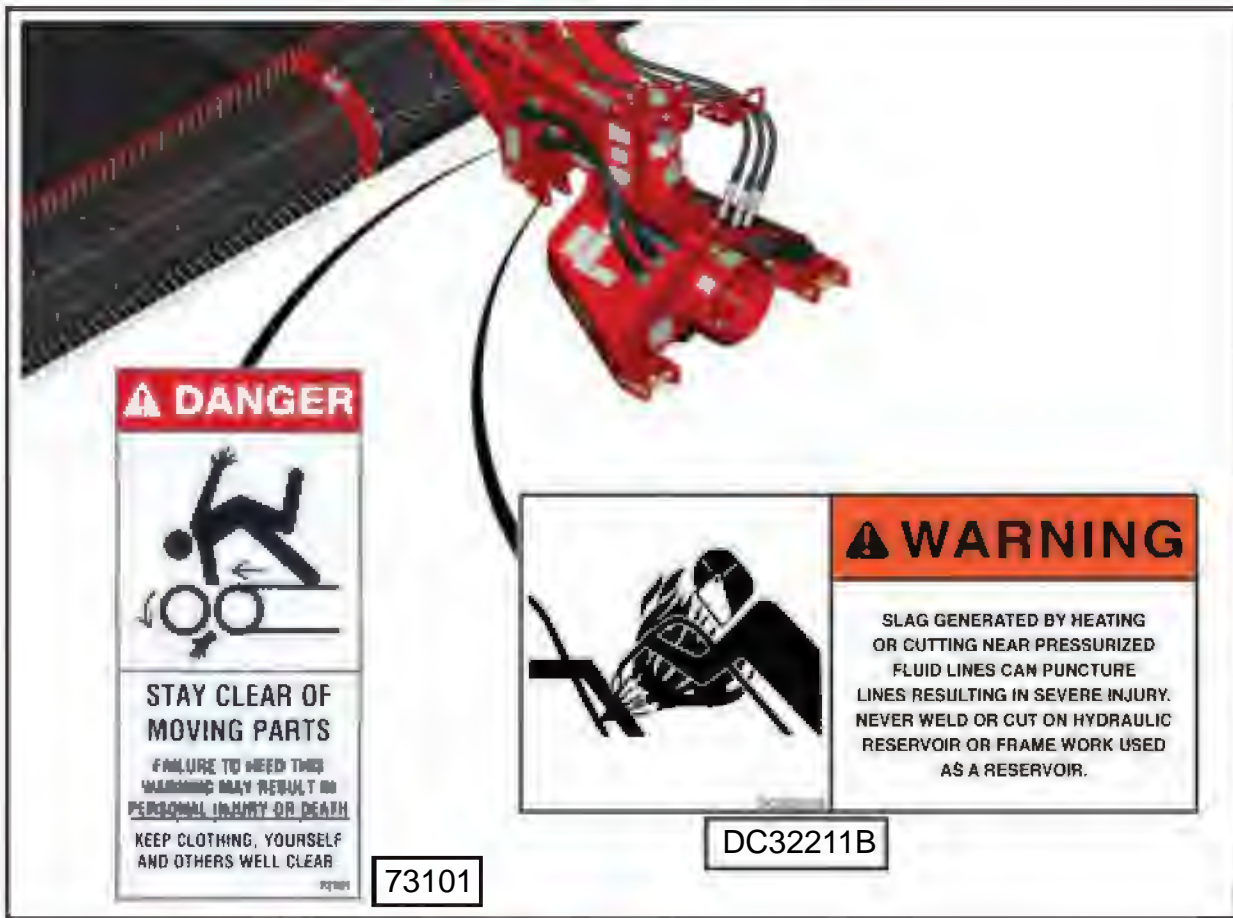

DECAL LOCATION

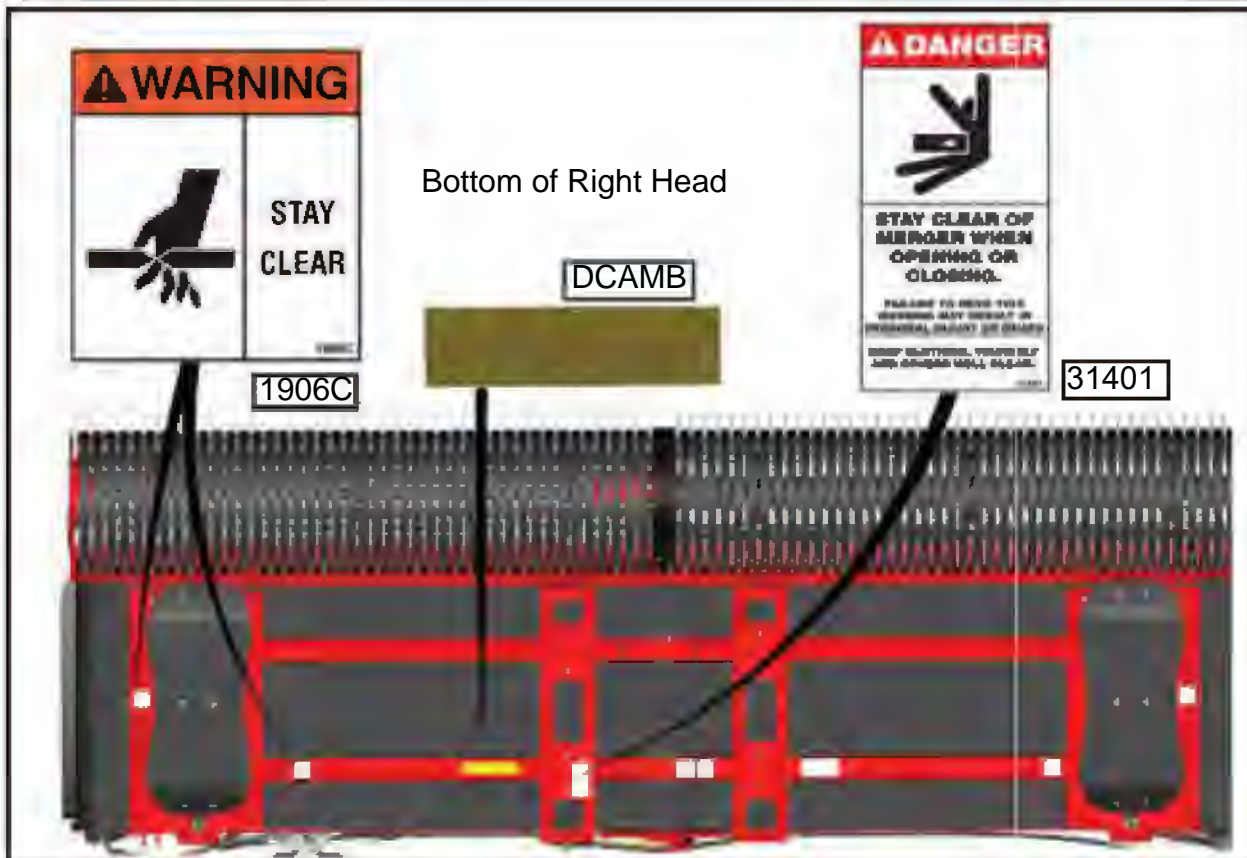

DECAL LOCATION

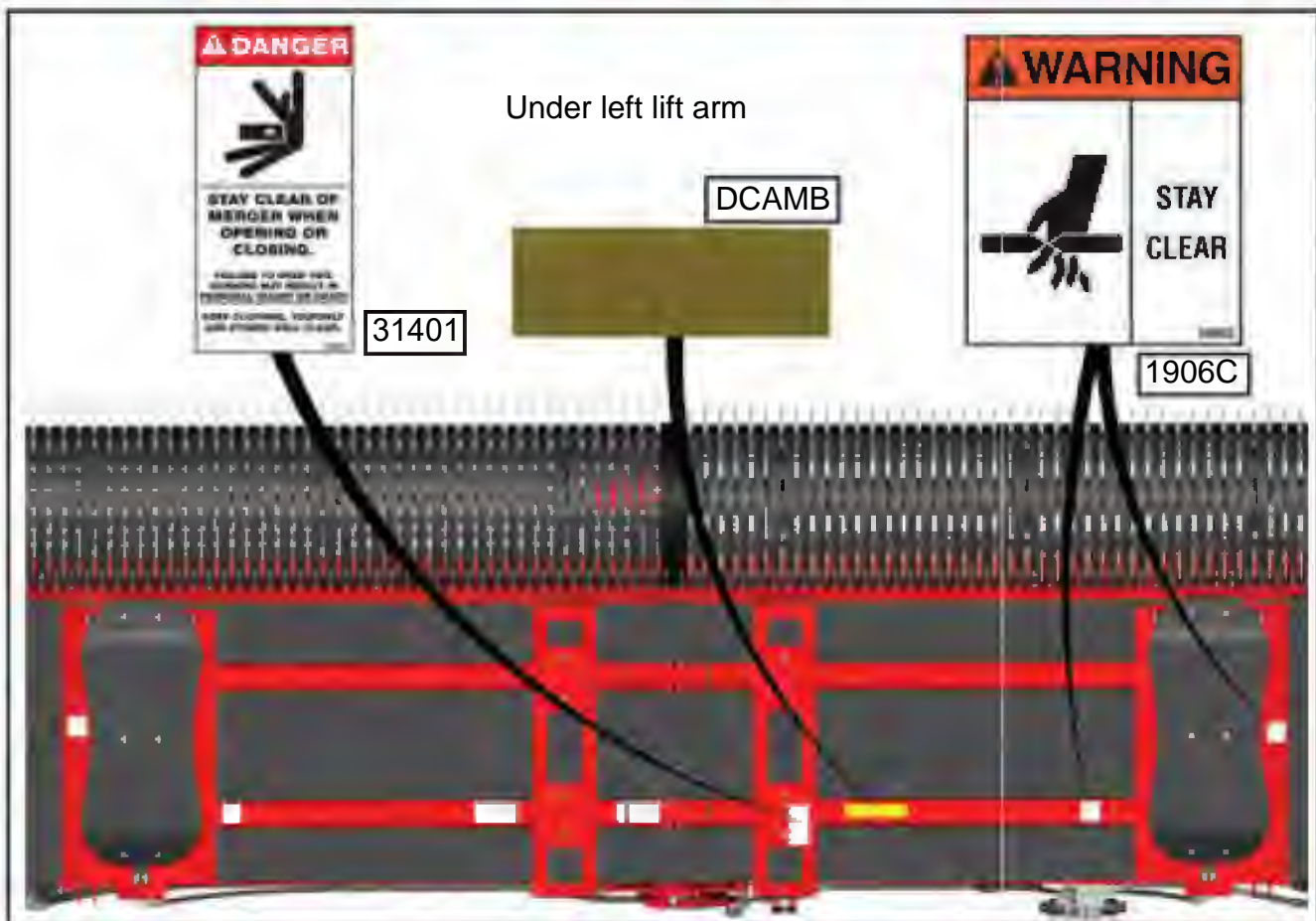
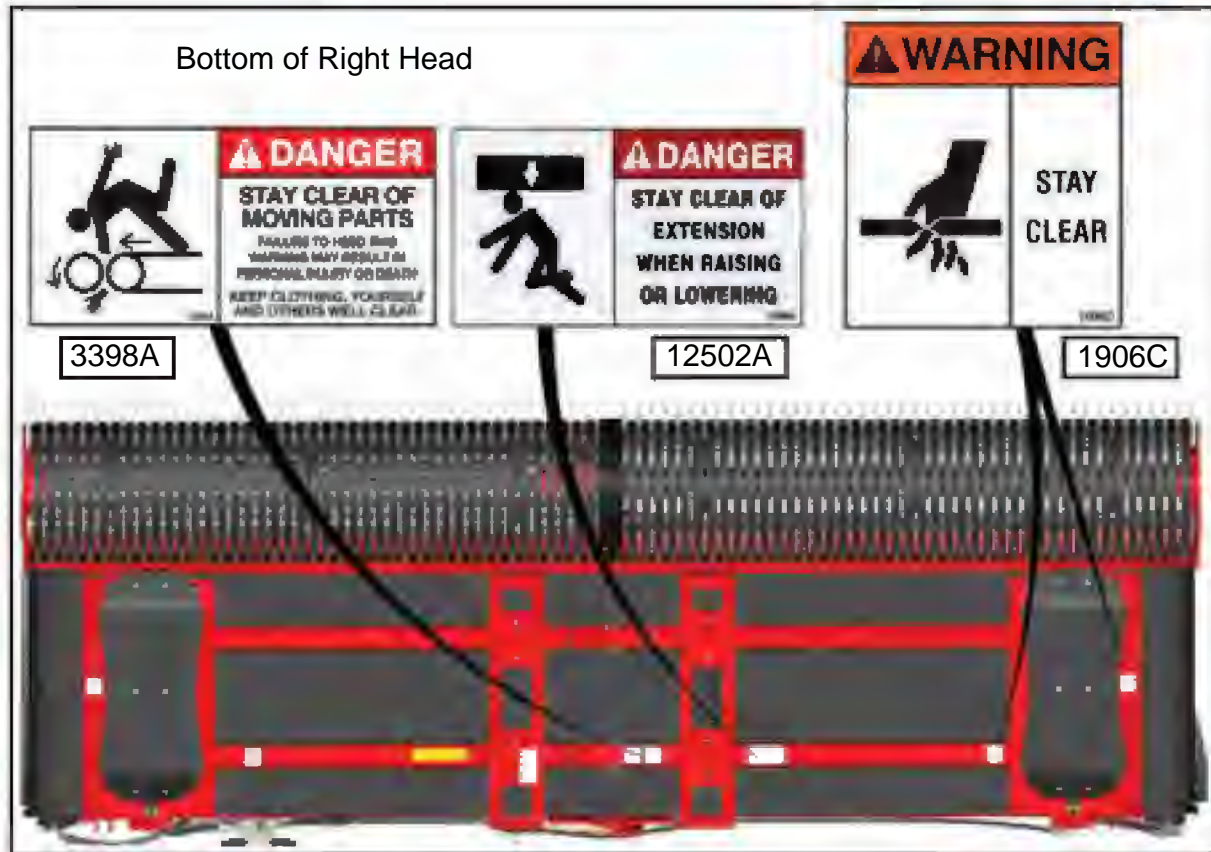

DECAL LOCATION

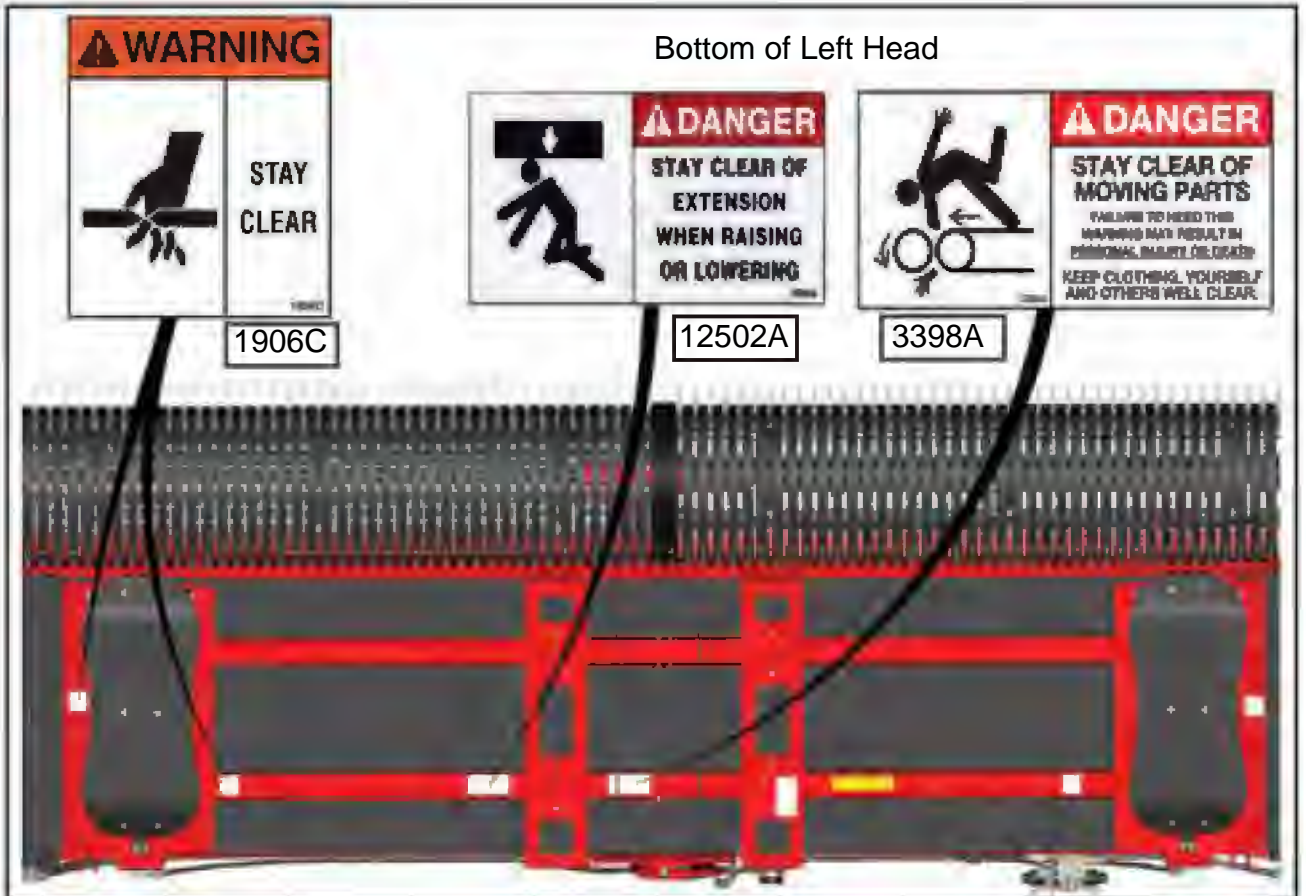

DECAL LOCATION



DECAL LOCATION

Under right lift arm



73101



31401

DECAL LOCATION

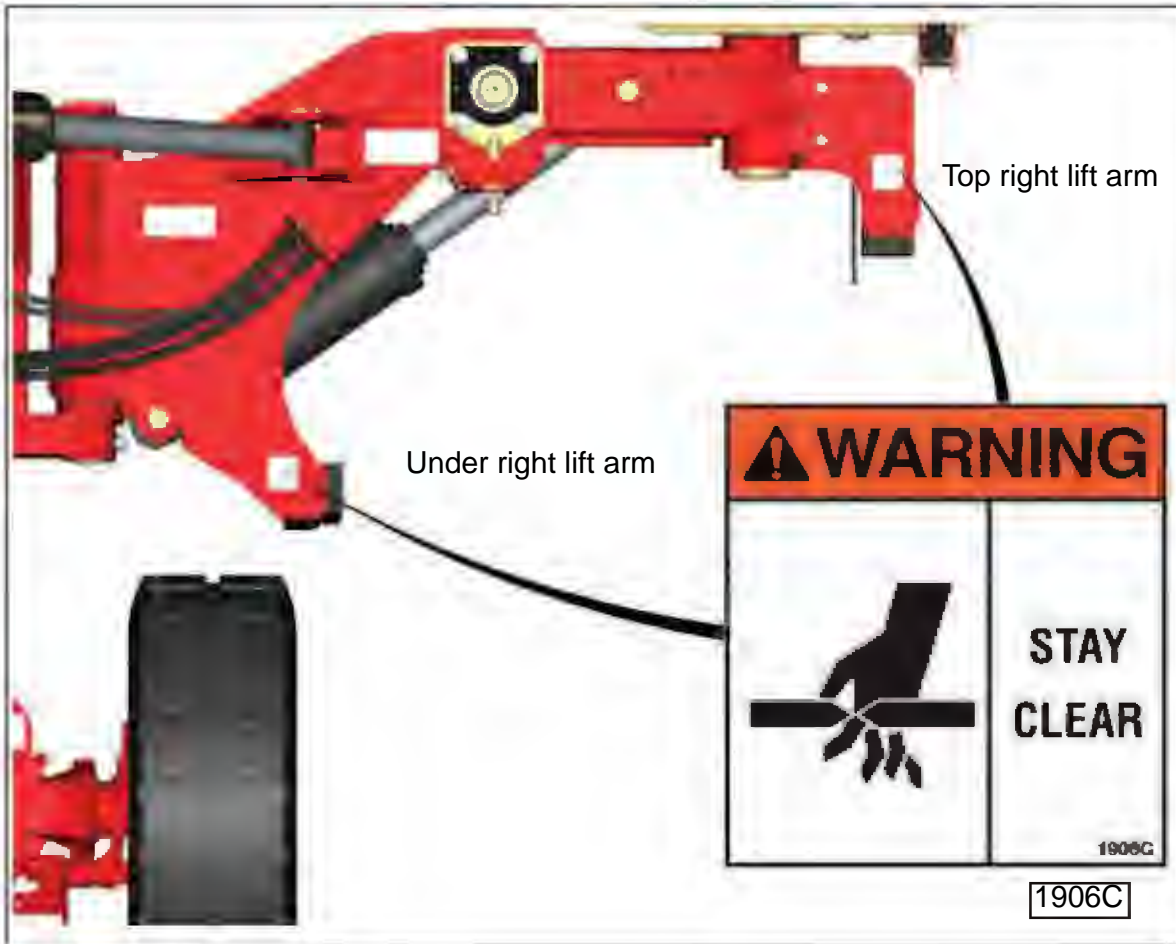
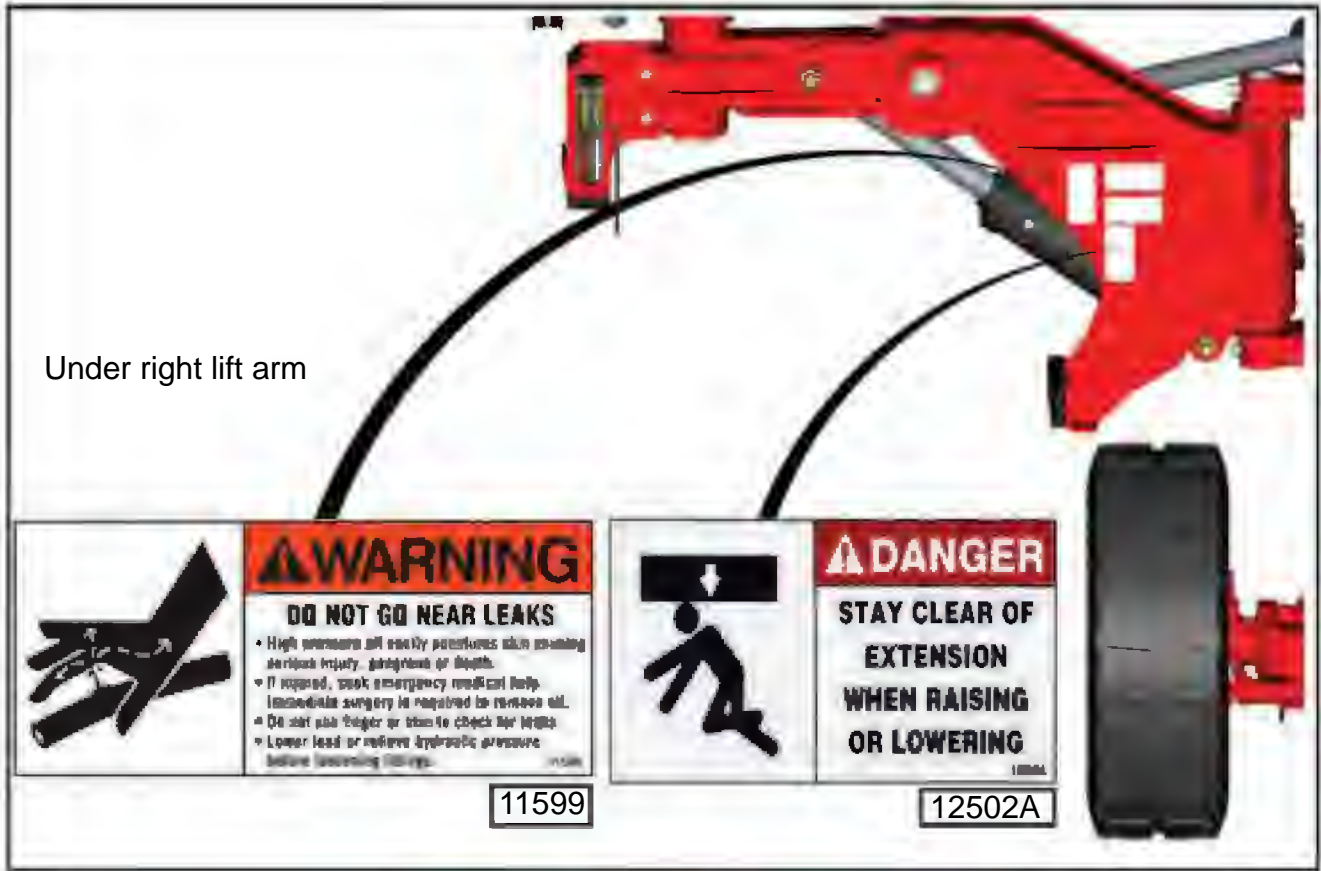

DECAL LOCATION



11599

Top right lift arm

DC32311B

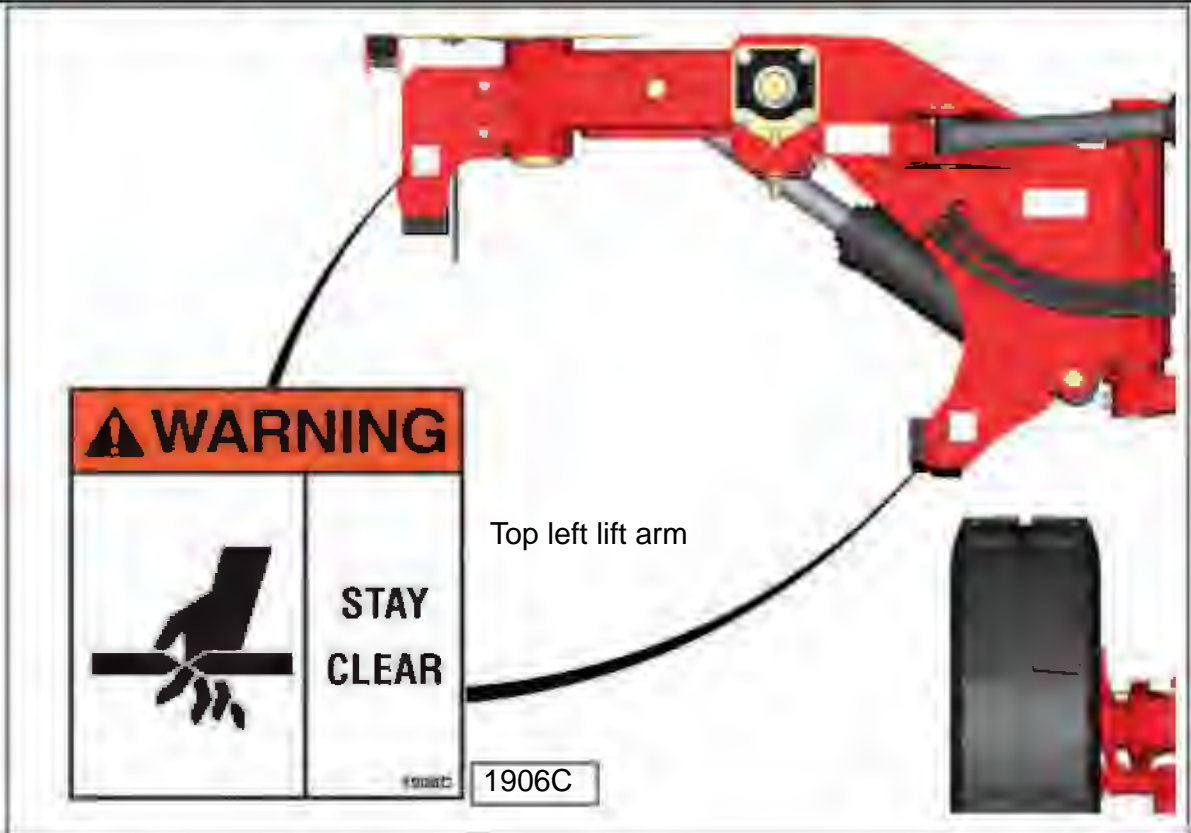

Top left lift arm

1906C

DECAL LOCATION

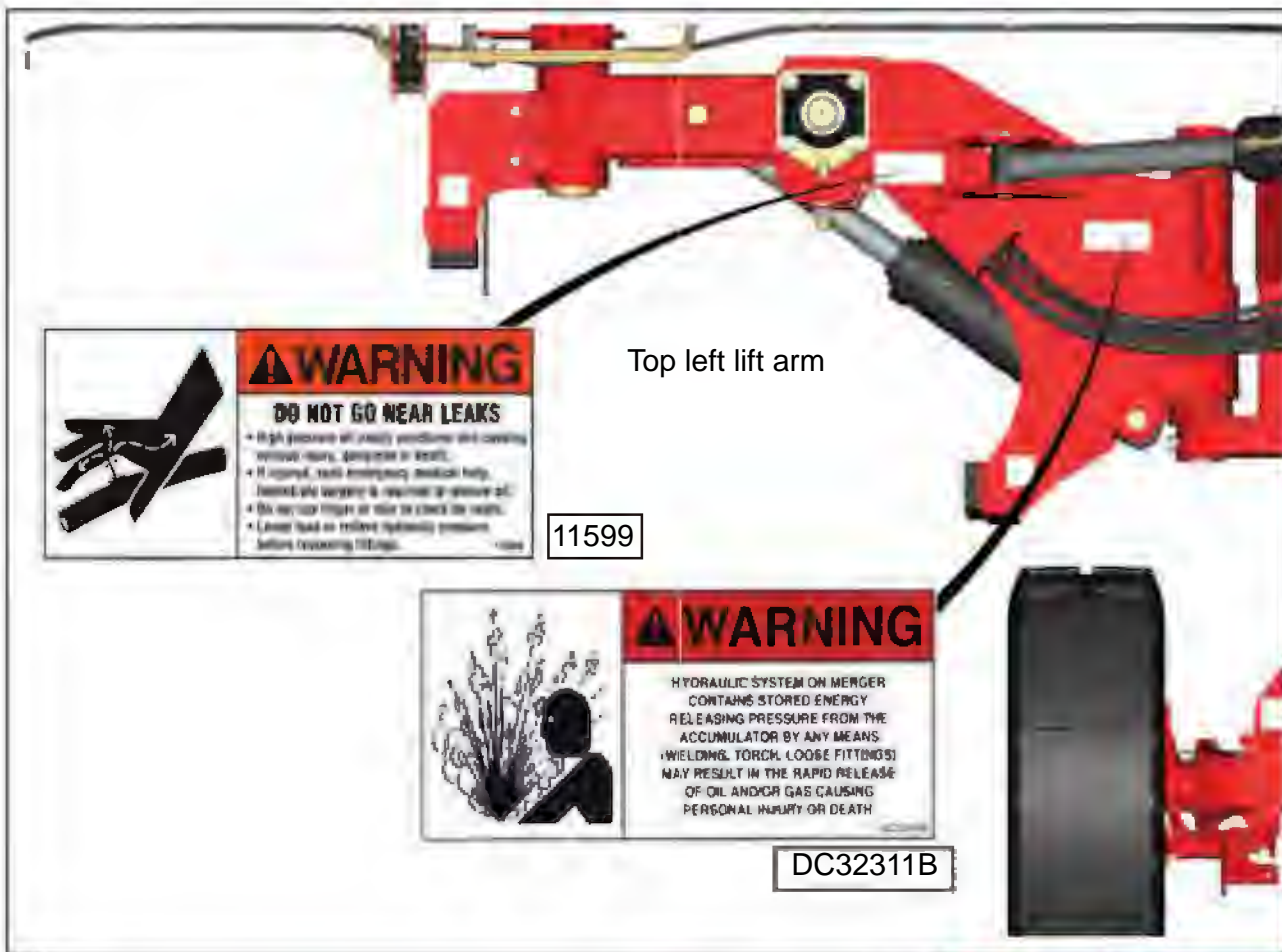

Top left lift arm



⚠ WARNING

DO NOT GO NEAR LEAKS

- High pressure oil under pressure and cooling serious injury, amputation or death.
- If injured, seek emergency medical help. Inform the surgeon to inform the doctor.
- Do not use the pump or side to check the leaks.
- Lower load or relieve hydraulic pressure before loosening fittings.

11599

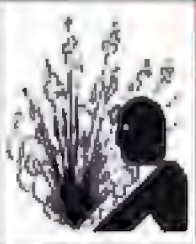

⚠ WARNING

HYDRAULIC SYSTEM ON MERGER CONTAINS STORED ENERGY. RELEASING PRESSURE FROM THE ACCUMULATOR BY ANY MEANS (WELDING, TORCH, LOOSE FITTINGS) MAY RESULT IN THE RAPID RELEASE OF OIL AND/OR GAS CAUSING PERSONAL INJURY OR DEATH.

DC32311B

⚠ WARNING

DO NOT GO NEAR LEAKS

- High pressure oil under pressure and cooling serious injury, amputation or death.
- If injured, seek emergency medical help. Inform the surgeon to inform the doctor.
- Do not use the pump or side to check the leaks.
- Lower load or relieve hydraulic pressure before loosening fittings.

11599

⚠ DANGER



STAY CLEAR OF MERGER WHEN OPENING OR CLOSING.

FAILING TO HEED THIS WARNING MAY RESULT IN PERSONAL INJURY OR DEATH.

KEEP CLOTHING, YOURSELF AND OTHERS WELL CLEAR.

31401

DECAL LOCATION



DECAL LOCATION

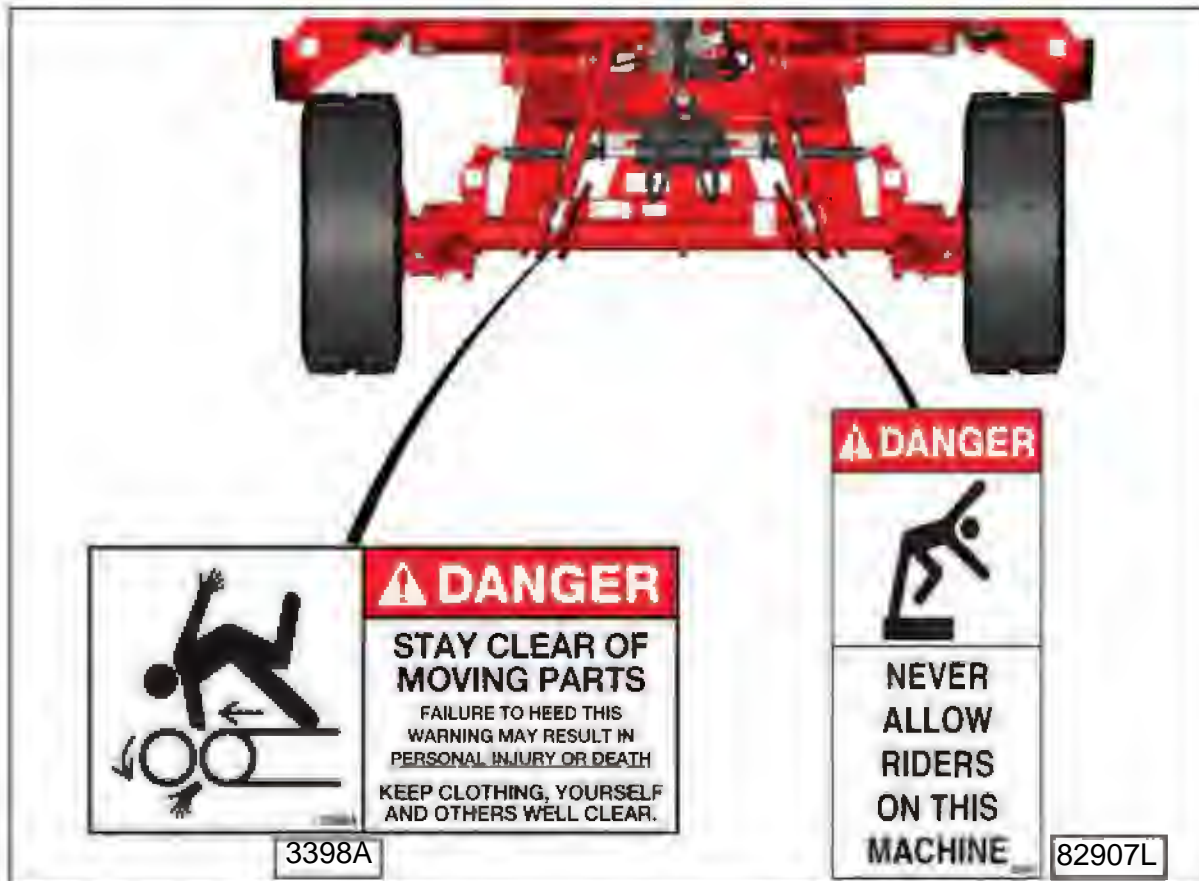
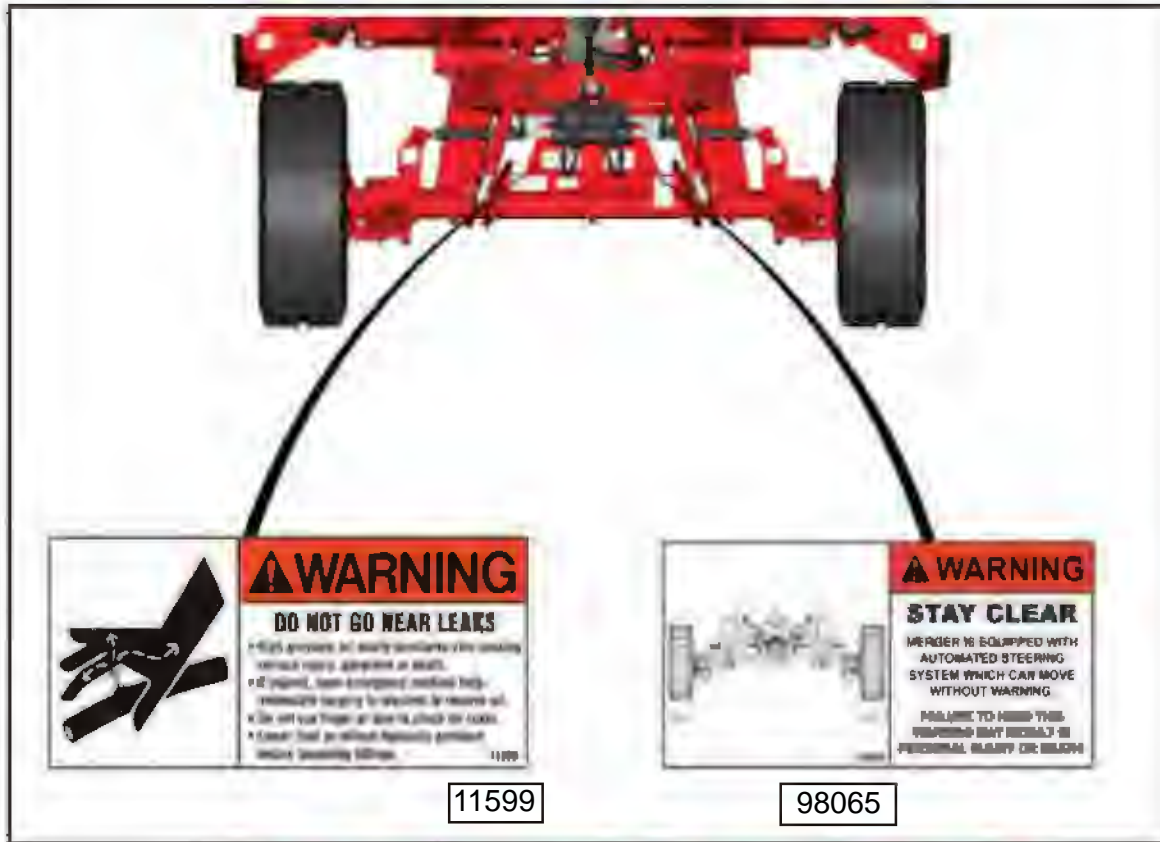

BRANDING LOCATION



BRANDING LOCATION

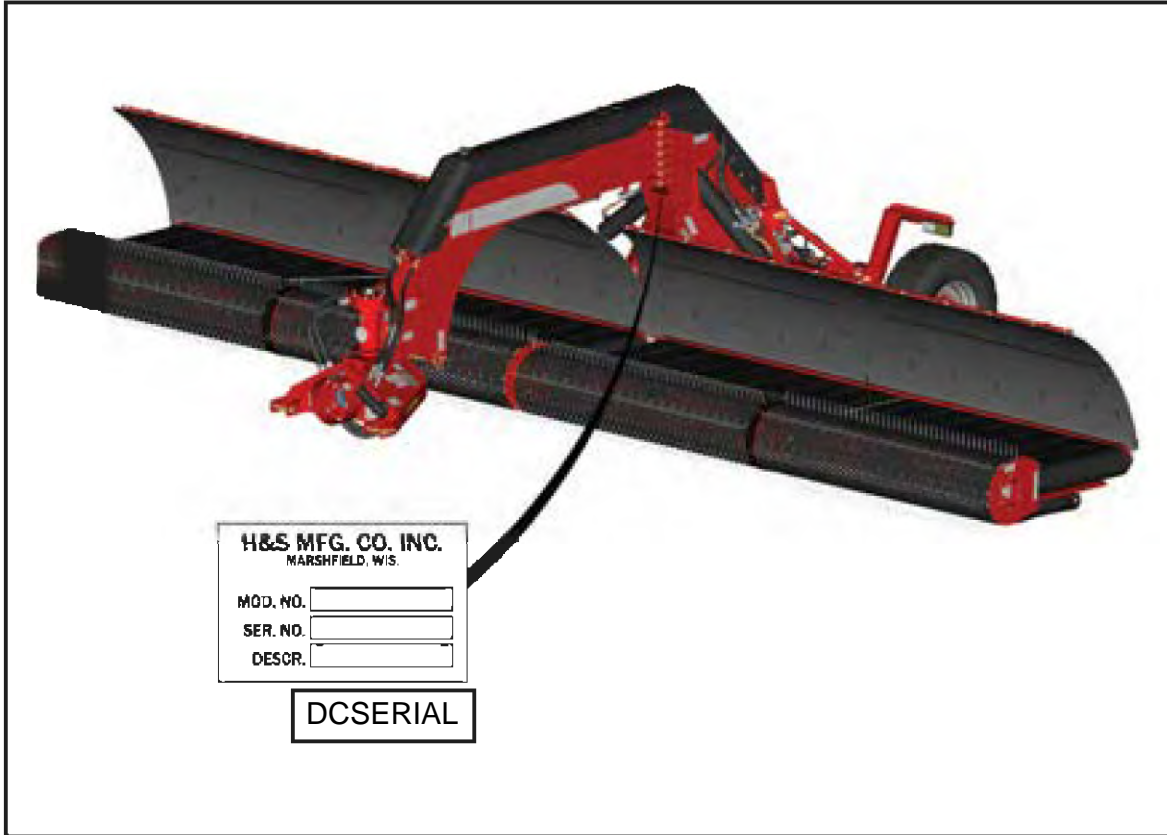

SERVICE NOTES



Manufactured By:

H&S MANUFACTURING CO., INC.

2608 S. HUME AVE. MARSHFIELD, WI 54449

(715) 387-3414 | hsmfgco.com

