



OPERATOR'S MANUAL

TF6132
TWIN-FLEX
MERGER

Part #94539
Rev. #07
HSMFG092624

Starting Serial #521TF63201



WARNING

READ AND UNDERSTAND THIS MANUAL BEFORE OPERATING THIS EQUIPMENT. UNSAFE OPERATION OR MAINTENANCE OF THIS EQUIPMENT CAN RESULT IN SERIOUS INJURY OR DEATH.

CONTENTS

Warranty	1
Manufacturer's Statement and Introduction	2
Warranty Registration Form	3
Limits of the Machine.	4
Dealer Pre-Delivery Checklist	5
Machine Specifications	6
Dealer Delivery Checklist	7
Safe Practices	8
Be Alert Symbol	9
Explanation of Safety Signs	10
Warning - Owner Must Read and Understand	11
Additional Safety information.	12-23
Cap Screw Torque Values	24
Hydraulic Fitting Torque Specifications	25-26
Start Up Guide.	27
Set-Up & Assembly.	28
Machine Prep & Operation	29-32
Operator Display	33-40
Adjustments	41-44
Service	45-47
Hoses	48
Blockages.	49
Optional Equipment	50-53
Lubrication Guide.	54-59
Decal Location & Identification	60-74
Branding Locations.	75-76
Emissions	77
Service Notes	78

WARRANTY

H&S Manufacturing Co., Inc. ("H&S") warrants this product to be free from defect in material and workmanship. Except as noted below, this warranty term is twelve (12) months on parts and labor from the date of delivery of the product to the original purchaser by an authorized H&S dealer. Under this warranty, H&S will repair or replace, at its option, any covered part which is found to be defective in material or workmanship during the applicable warranty term. In no case will the covered repair cost of a part or parts exceed the replacement cost of that part. In no case, unless pre-authorized by H&S, will a component be replaced versus repaired unless the cost of labor and parts exceeds 75% of the cost of a new component. Warranty repairs must be performed by H&S or a dealer authorized by H&S to sell and/or service the product involved, and will use only new or remanufactured parts or components furnished by H&S. Any warranty repairs needing to be performed by a third party must be pre-authorized by H&S. Standard freight costs will be covered by H&S for any part used to make a warrantable repair, any form of express freight will not be covered unless pre-authorized by H&S. This warranty includes approved parts and labor to repair the product but does not include, and the purchaser is responsible for, any service call and/or transportation of the product to and from the dealer's place of business, for any costs related to travel, for any premium charged for overtime labor requested by the purchaser, and for any service work not directly related to any defect covered under this warranty. This warranty includes only those components of the product manufactured by H&S. Warranty for any component not manufactured by H&S including, but not limited to, engines, batteries, tires, rims, hydraulic motors, pumps, etc. are covered by the warranty, if any, provided separately by their respective manufacturers. H&S reserves the right to request the return of any failed component.

This warranty in all its parts is extended solely to the original purchaser of the product, is terminated upon any subsequent transfer or sale from or by the original purchaser, and extends no third party benefits or rights whatsoever.

The warranty term for any product used in any for hire, rental fleet or rental application, is limited to six (6) months from the date of delivery of the product to the original purchaser by an authorized H&S dealer.

This warranty does not include: (1) Any product that has been altered or modified in ways not approved by H&S; (2) Depreciation or damage caused by normal wear, use for which the product was not designed, misuse, improper or insufficient maintenance, improper operation, accident or failure to follow the product Operator's Manual recommendations and product decal recommendations; (3) Normal maintenance parts and service; (4) Repairs made with parts other than those available from H&S or performed by anyone other than H&S or a dealer authorized by H&S to sell and/or service the product involved.

To secure warranty service the purchaser must report the product defect to a dealer authorized by H&S to sell and/or service the product involved within the applicable warranty term together with evidence of the warranty start date and make the product available to that dealer within a reasonable period of time. For these warranty terms to be in effect the selling authorized H&S dealer and/or the customer must submit the warranty registration to H&S.

THERE ARE NO WARRANTIES WHICH EXTEND BEYOND THE DESCRIPTION ON THE FACE OF THIS WARRANTY. H&S and the companies affiliated with it make no warranties, representations, or promises, express or implied, as to the performance or freedom from defect of its products other than those set forth above and NO IMPLIED WARRANTY OF MERCHANTABILITY, FITNESS OR FITNESS FOR A PARTICULAR PURPOSE IS MADE. IN NO EVENT WILL THE DEALER, H&S OR ANY COMPANY AFFILIATED WITH H&S BE LIABLE FOR INCIDENTAL OR CONSEQUENTIAL DAMAGES. The ONLY REMEDY the purchaser has in connection with the breach of performance of any warranty on H&S products are those set forth above.

The selling dealer has no authority to make any representation or promise on behalf of H&S, or to modify the terms or limitations of this warranty in any way.

12/21/22

MANUFACTURER'S STATEMENT

Your New H&S Product has been manufactured of the finest quality materials and components. The performance you get from your machine is largely dependent upon how well you read and understand this manual and apply this knowledge. There is a right and a wrong way to do everything. Please do not assume that you know how to operate and maintain your Machine before reading this manual carefully. Keep this manual available for ready reference.

INTRODUCTION

The TF6132 Twin Flex Mergers are designed exclusively for agricultural use and are suitable for lifting and merging forage crops that have been cut and are lying on the ground. Use of the machine for any other purpose is not recommended as it falls outside the specifications and is carried out at the owner's own risk. The manufacturer cannot be held responsible for any damages that occur as a result of such misuse.



Please note that dry hay/forage/straw can be combustible, and sparks caused by scraping stones or rocks can ignite these materials. Therefore, it is essential to remain alert at all times when operating the machine and be prepared for any fire emergency.

The operation, routine maintenance, and repair of this machine must follow the application stipulations outlined by the manufacturer and must be strictly adhered to by all personnel involved. Only individuals who have been thoroughly instructed on the hazards associated with farm machinery should operate, service, or repair the machine. All relevant safety and highway regulations must be followed at all times to prevent accidents.

For any assistance required regarding the operation or service of the machine, please contact your nearest H&S dealer.

Information described within this manual was correct at the time of printing. Because of our Continuous improvement program, certain information may not be included in this manual. To obtain the most up to date information please use the H&S portal to find the latest Parts books and Operators Manuals

H&S reserves the right to make changes or add improvements to its products at any time without incurring any obligation to make such changes to products previously manufactured. Specifications, statements and descriptions of Products contained in this publication are subject to change without prior notification.

WARRANTY REGISTRATION

- Date of Purchase: _____
- Purchaser Name: _____
- Street Address: _____
- City: _____
- State: _____ Zip: _____
- Phone Number: _____
- E-mail Address: _____
- Product: _____
- Model Number: _____
- Serial Number: _____
- You have received the Operator's Manual for this product. Yes _____ No _____
- Interested in receiving the H&S E-mail Newsletter? Yes _____ No _____

-
- Dealer Name: _____
 - Street Address: _____
 - City: _____
 - State: _____ Zip: _____
 - Signature: _____

- All fields must be filled out to ensure prompt notification of product and/or warranty updates.

**Please mail the completed WARRANTY REGISTRATION FORM to:
H&S Manufacturing Co., Inc.
2608 S. Hume Ave.
Marshfield, WI 54449**

Limits of the Machine

INTENDED USAGE

It is important that this manual be read and understood by the operator and maintenance personnel before attempting to operate or perform any maintenance on this machine. This manual contains information that will contribute to the safe, reliable and most productive operation of the Model TF6132 Merger.

Models TF6132 Merger is designed as tow behind unit. The harvesting speed and performance may depend on a number of limiting parameters, such as weather and terrain conditions, and crop maturity. Though the machine is designed to perform in most of these conditions, there may be a number of combinations of the above parameters, for which there is severe degradation of performance of the machine or systems thereof. If you notice degradation of performance, contact your H&S dealer for assistance.

PROHIBITED USAGE

No parts or attachments should be fitted to this machine, which have not been released by Oxbo. They might affect machine operation, safety of the user or other people, stability, or wear characteristics of the machine.

NOTICE: DO NOT use this machine for any purpose or in any manner other than as described in the manual, decals, or other product safety information provided with the machine. These materials define the machine's intended use.

Do not use your machine for another purpose than intended by the manufacturer and within its limits.



AVOID TIP-OVERS
CAUTION: FAILURE TO COMPLY WITH THE ABOVE WARNINGS CAN CAUSE THE MERGER AND TRACTOR TO TIP OVER AND RESULT IN SERIOUS PERSONAL INJURY.

- **ALWAYS** wear a Seat belt when operating equipment
- Always adapt ground speed to road or field conditions.
- Avoid making sharp turns when driving up or down slopes or when driving across slopes.
- Be especially careful when turning on slopes.
- When making turns, always take into consideration the width of the conveyors.
- Reduce ground speed when driving on slopes or over uneven ground and before making sharp turns, especially on hillsides.
- Avoid holes, ditches and obstructions which may cause the merger to tip, particularly on hillsides.
- Avoid passing over weak or fragile bridge-heads and bridge-floors
- in poor condition which may cause the machine to tip.
- Never drive near the edge of a ditch, creek, gully or steep embankment.
- Do not operate on hillsides over a 25% slope.

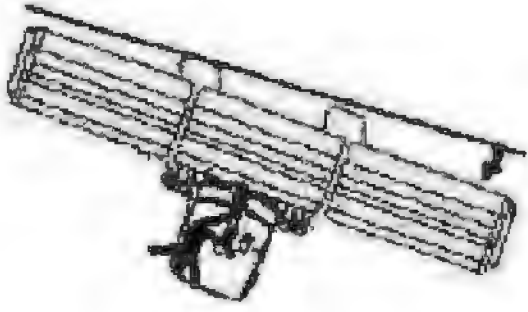

DEALER PRE-DELIVERY CHECKLIST

AFTER COMPLETION, DEALER SHOULD REMOVE AND RETAIN FOR RECORDS

After the Merger has been completely set up, check to be certain it is in correct operating order before delivering to the customer. The following is a list of points to inspect. Check off each item as you have made the proper adjustments and found the item operating satisfactorily.

- Merger was not damaged in shipment. Check for dents and loose or missing parts. Report damage immediately to H&S Manufacturing Co., Inc.
- Merger has been correctly assembled according to dealer set up instructions. Wheel nuts and all other fasteners are tightly secured.
- Visually look over machine for any loose hardware.
- All grease fittings have been lubricated. See LUBRICATION section of this manual for details.
- Hoses and fittings are properly attached and there are no visible leaks.
- All belts are at proper tension.
- PTO Shields turn freely.
- All shields and guards are in place and fastened.
- All mechanisms are operating trouble free.
- Tires are inflated to correct pressure.
- Decals are in place and legible.
- Hook machine to tractor to make sure four green lights are visible. One on the main controller and three on the cam expanders.

Model Number _____

Serial Number _____

Dealer's Name _____

Inspection Date _____

Signature of Pre-Delivery Inspector _____

(Remove Dealers File Copy At Perforation)

Machine Specifications

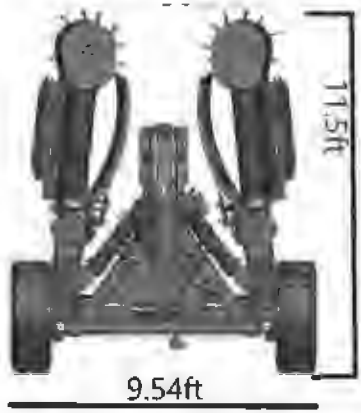
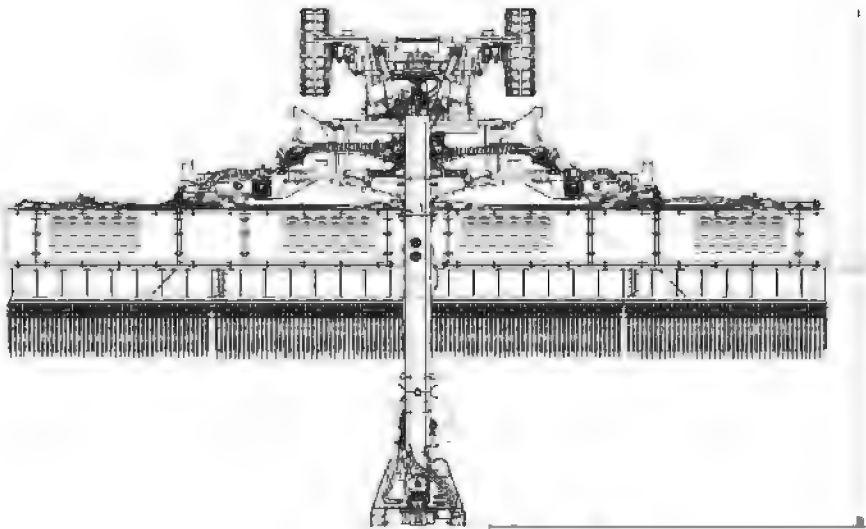
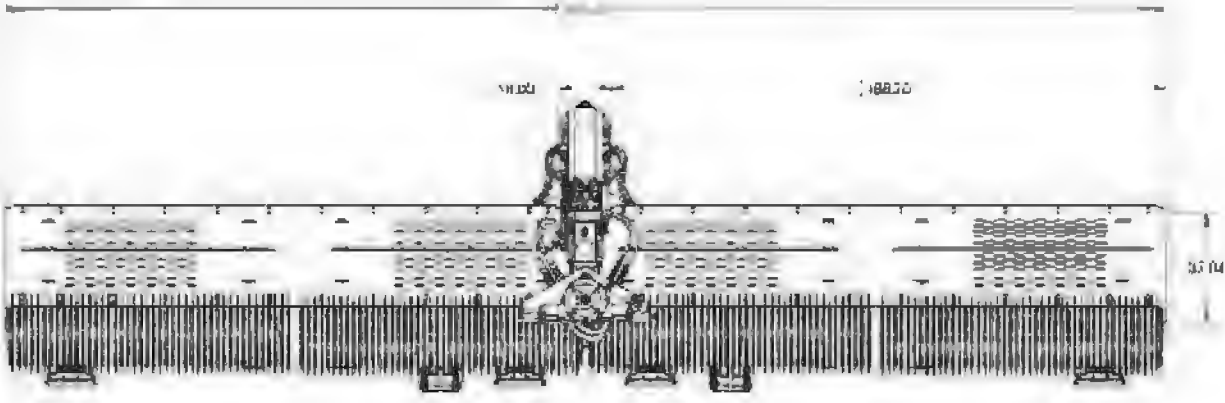

Weight	17185.51 Pounds
Overall length	207.10 Feet
Width	32.95 Feet
Transport Height	11.50 Feet
Transport Width	9.54 Feet

DEALER DELIVERY CHECKLIST

AFTER COMPLETION, DEALER SHOULD REMOVE AND RETAIN FOR RECORDS

This check list that follows is an important reminder of valuable information that should be passed on to the customer at the time this Merger is delivered.

Check off each item as you explain it to the customer.

This delivery checklist, when properly filled out and signed assures the customer that the pre-delivery service was satisfactorily performed.

- Explain to the customer that the pre-delivery inspection was made.
- Explain to the customer all the safety precautions they must exercise when operating this unit.
- Explain to the customer the operation and adjustments of the Merger.
- Explain to customer that regular lubrication is required for proper operation and long life of the machine.
- Show the customer the LUBRICATION section of Operator's Manual.
- Give the customer Operator's Manual and make sure they read and understand all operating and service instructions.
- Have the customer sign a completed "Warranty Registration" and mail it.

Date Delivered _____

Dealer's Name _____

By _____

Signature of Original Buyer _____

Note: Warranty is not valid until warranty card is completed and returned to H&S Mfg. Co., Inc.

Safe Practices

Safe practices developed from experience in the use of mergers are described in this manual. Safe installation, operation, and servicing practices have evolved through research, development, and field experience. Accidents occur when equipment is improperly used or maintained. The reason for the safe practices may not always be given. Some are based on common sense; others may require technical volumes to explain. It is wiser to follow the rules.

Read and understand these safe practices before attempting to install, operate, or service the equipment. Comply with these procedures for personal safety and for the safety of others. Improper use of the merger may result in injury. To reduce this possibility, pay complete attention to the job at hand and observe the following cautions. If you can prevent an accident, your time is well spent.

DO:

- Sound horn and make sure everyone is clear of the machine before starting the tractor engine.
- Visually check for obstacles or people before moving the machine.
- Keep people away from the merger during operation.
- Turn off tractor engine before fueling.
- Slow the tractor down when rough terrain appears imminent or when turning.
- **ALWAYS** use wear a seatbelt or safety restraints while operating equipment

DO NOT:

- Operate without safety covers, guards, shields, and safety signs in place.
- Disable safety switches or safety devices.
- Operate on dangerous terrain.
- Operate beyond the intended use of the machine.

PRECAUTIONS:

- Never operate the tractor or merger while under the influence of alcohol, drugs, or while under fatigue.
- Read the tractor and merger operator manuals completely to ensure safe operation.
- Avoid loose, bulky clothing.
- When working in muddy areas, remove soil and mud from the bottom of your shoes before mounting the merger.
- Keep a first aid kit and a fire extinguisher nearby at all times.
- Avoid touching hot hydraulic components during, or immediately after operation. Service or check merger only after it has cooled off.

SAFETY INFORMATION

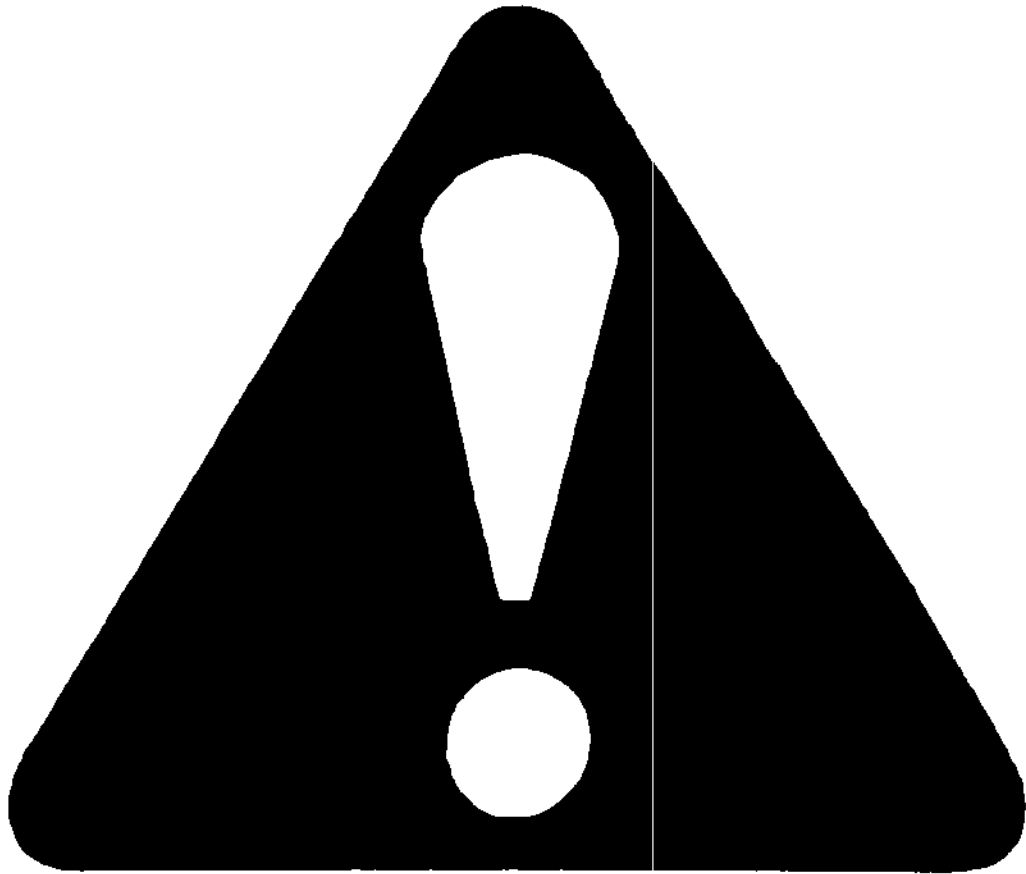

**BE
ALERT!**

**YOUR SAFETY
IS INVOLVED.**

THIS SYMBOL IS USED THROUGHOUT THIS BOOK WHENEVER YOUR PERSONAL SAFETY IS INVOLVED. TAKE TIME TO BE CAREFUL. REMEMBER: THE CAREFUL OPERATOR IS THE BEST OPERATOR. MOST ACCIDENTS ARE CAUSED BY HUMAN ERROR. CERTAIN PRECAUTIONS MUST BE OBSERVED TO PREVENT THE POSSIBILITY OF INJURY OR DAMAGE.

H&S MANUFACTURING CO., INC.

SAFETY INFORMATION

RECOGNIZE SAFETY INFORMATION

This is the safety alert symbol. When you see this symbol on your machine or in this manual, be alert to the potential for personal injury.

Follow recommended precautions and safe operating practices.



UNDERSTAND SIGNAL WORDS

A signal word - DANGER, WARNING, or CAUTION - is used with the safety alert symbol. DANGER identifies the most serious hazards.

Safety signs with signal word DANGER or WARNING are typically near specific hazards.

General precautions are listed on CAUTION safety signs.



FOLLOW SAFETY INSTRUCTIONS

Carefully read all safety messages in this manual, and all safety signs on your machine. Follow all recommended precautions and safe operating procedures.

Keep signs in good condition. Immediately replace any missing or damaged signs.

OBSERVE MAXIMUM TRANSPORT SPEED

The maximum transport speed for this implement is 32 km/h (20 mph).

Some tractors are capable of operating at speeds that exceed the maximum transport speed of this implement. Regardless of the maximum speed capability of the tractor being used to tow this implement, do not exceed the implement's maximum transport speed.

Exceeding the implement's maximum transport speed can result in:

- * Loss of control of the tractor/implement combination
- * Reduced or no ability to stop during braking
- * Implement tire failure
- * Damage to the implement structure or its components

Use additional caution and reduce speed when towing under adverse surface conditions, when turning, and when on inclines.

Do not attempt transport if the fully loaded implement weighs more than 1.5 times the weight of the tractor.



SAFETY INFORMATION

TRACTOR:

This Operator's Manual uses the term "Tractor" when identifying the power source.



TO PREVENT SERIOUS INJURY OR DEATH

BEFORE YOU ATTEMPT TO OPERATE THIS EQUIPMENT, READ AND STUDY THE FOLLOWING INFORMATION. IN ADDITION, MAKE SURE THAT EVERY INDIVIDUAL WHO OPERATES OR WORKS WITH THIS EQUIPMENT, WHETHER FAMILY MEMBER OR EMPLOYEE, IS FAMILIAR WITH THESE SAFETY PRECAUTIONS.

DO NOT ALLOW PERSONNEL OTHER THAN THE QUALIFIED OPERATOR NEAR THE MACHINE.
KNOW HOW TO STOP MACHINE BEFORE STARTING IT.

BEFORE starting tractor, be sure PTO shields turn freely and PTO is securely locked to tractor.

Stop the tractor engine, remove ignition key and allow all mechanisms to stop before cleaning or working on the machine.

If the machine becomes clogged or requires servicing, disengage the tractor PTO or tractor hydraulics.

DO NOT attempt to perform maintenance or repair with tractor running and PTO or tractor hydraulics hooked up.

DO NOT step up on machine at any time.

NEVER manually feed material into the pickup.

DO NOT allow minors to operate or be near the machine.

DO NOT clean, adjust, or lubricate the machine when any part is in operation.

STAY CLEAR of machine when rasing and lowering machine and during folding and unfolding machine.

KEEP hands, feet, and clothing away from pickup conveyor belts WHEN THEY ARE IN MOTION.

LOOSE and floppy clothing should not be worn by the operator.

BE SURE the machine is clear of people tools, and other objects before engaging PTO or tractor hydraulics.

STAY CLEAR of hydraulic lines and fittings. They may be under extreme pressure or heat.

NEVER start the Merger until all guards and safety shields are in place.

CAUTION - Beware of low electrical wires.

H&S Manufacturing Co. always takes the operator and their safety into consideration and guards exposed moving parts for their protection. However, some areas cannot be guarded or shielded in order to ensure proper operation. In addition, the operators manual and decals on the machine itself warn you of further danger and should be read and observed closely.

Study The Above Safety Rules
ATTENTION - BE ALERT - YOUR SAFETY IS INVOLVED

SAFETY SIGNS

CLEAN: Keep all safety signs clean and unobstructed

REPLACE: Replace missing or damaged safety signs. See the machine operator's manual for correct safety sign placement. Replacement safety signs can be ordered from your Oxbo dealer.

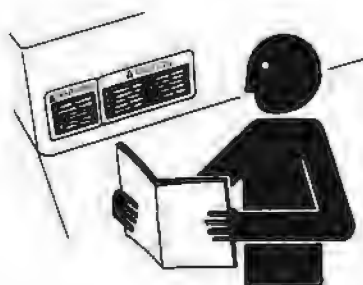

FOLLOW SAFETY INSTRUCTIONS

Carefully read all safety messages in this manual and on your machine. Keep safety signs in good condition. Replace missing or damaged safety signs. Be sure new equipment components and repair parts include the current safety signs. Replacement safety signs are available from your dealer.

Learn how to operate the equipment and how to use controls properly. Do not let anyone operate without instruction.

Keep your equipment in proper working condition. Unauthorized modifications to the equipment may impair the function and/or safety and affect equipment life.

If you do not understand any part of this manual and need assistance, contact your dealer.

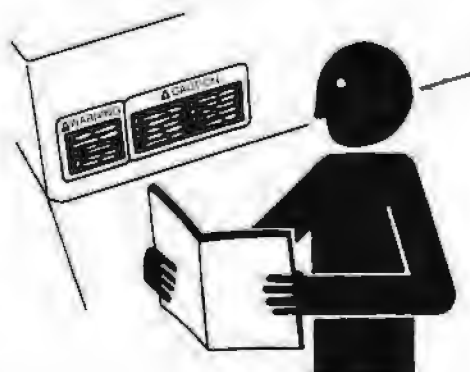

READ OPERATOR'S MANUAL

Read your operator's manual thoroughly to learn how to operate the machine and how to use controls properly. Do not allow anyone to operate this machine without instruction.



USE YOUR TRACTOR OPERATOR'S MANUAL

Always refer to YOUR tractor operator's manual for specific detailed information regarding operation of YOUR equipment.



PREPARE FOR EMERGENCIES

Be prepared if a fire starts.

Keep a first aid kit and fire extinguisher handy.

Keep emergency numbers for doctors, ambulance service, hospital, and fire department near your telephone.

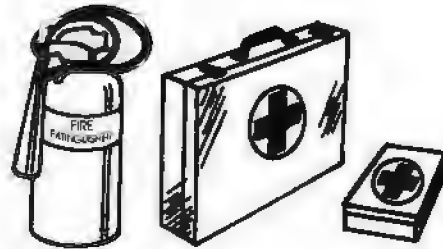

PRACTICE SAFE MAINTENANCE

Understand service procedure before doing work. Keep area clean and dry.

Never lubricate, service, or adjust machine while it is running. Keep hands, feet, and clothing from power-driven parts. Disengage all power and operate controls to relieve pressure. Lower equipment to the ground. Stop tractor engine. Remove the key. Allow machine to cool.

Securely support any elements that must be raised for service work.

Keep all parts in good condition and properly installed. Fix damage immediately. Replace worn or broken parts. Remove any buildup of grease, oil, or debris.



WEAR PROTECTIVE CLOTHING

Wear close fitting clothing and safety equipment appropriate to the job.

Prolonged exposure to loud noise can cause impairment or loss of hearing.

Wear a suitable hearing protective device such as earmuffs or earplugs to protect against objectionable or uncomfortable loud noises.

Operating equipment safely requires the full attention of the operator. Do not wear radio or music headphones while operating machine.

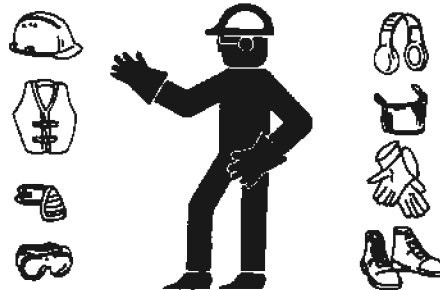

PROTECT AGAINST NOISE

Prolonged exposure to loud noise can cause impairment or loss of hearing.

Wear a suitable hearing protective device such as earmuffs or earplugs to protect against objectionable or uncomfortable loud noises.



SERVICE EQUIPMENT SAFELY

Tie long hair behind your head. Do not wear a necktie, scarf, loose clothing, or necklace when you work near moving parts. If these items were to get caught, severe injury could result.

Remove rings and other jewelry to prevent electrical shorts and entanglement in moving parts.

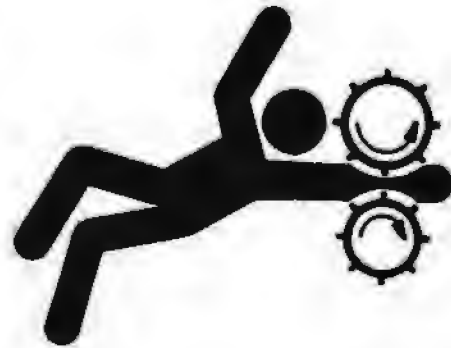

HANDLE CHEMICAL PRODUCTS SAFELY

Direct exposure to hazardous chemicals can cause serious injury. Potentially hazardous chemicals used with this equipment include such items as lubricants, coolants, paints, and adhesives.

A Safety Data Sheet (SDS) provides specific details on chemical products: physical and health hazards, safety procedures, and emergency response techniques.

Check the SDS before you start any job using a hazardous chemical. That way you will know exactly what the risks are and how to do the job safely. Then follow procedures and use recommended equipment.

(See your dealer for SDS's on chemical products used with your merger.)



AVOID HIGH-PRESSURE FLUIDS

Escaping fluid under pressure can penetrate the skin causing serious injury.

Avoid the hazard by relieving pressure before disconnecting hydraulic or other lines. Tighten all connections before applying pressure.

Search for leaks with a piece of cardboard. Protect hands and body from high pressure fluids.

If an accident occurs, see a doctor immediately. Any fluid injected into the skin must be surgically removed within a few hours or gangrene may result. Doctors unfamiliar with this type of injury should reference a knowledgeable medical source.

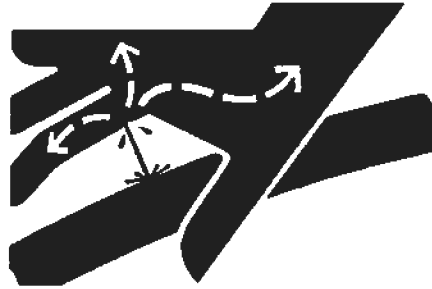

SERVICE ACCUMULATOR SYSTEM SAFELY

Escaping fluid or gas from pressurized hydraulic accumulator systems can cause serious injury. Extreme heat can cause the accumulator to burst, and pressurized lines can be accidentally cut. Do not weld or use a torch near a pressurized accumulator or pressurized line.

Relieve pressure from the hydraulic system before removing accumulator. Never attempt to relieve hydraulic system or accumulator pressure by loosening a fitting.

Accumulators cannot be repaired.



WARNING: USE ONLY DRY NITROGEN TO CHARGE ACCUMULATOR. USE OF ANOTHER GAS CAN RESULT IN AN EXPLOSION CAUSING DEATH AND/OR DAMAGE TO THE MACHINE.

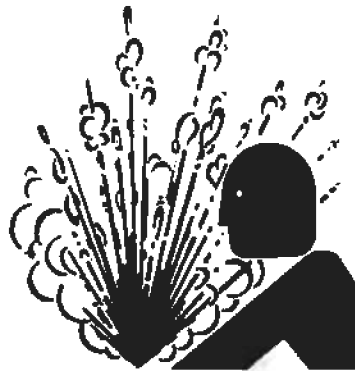

DISPOSE OF WASTE PROPERLY

Improperly disposing of waste can threaten the environment and ecology. Potentially harmful waste used with agricultural equipment include such items as oil, fuel, coolant, brake fluid, filters, and batteries.

Use leakproof containers when draining fluids. Do not use food or beverage containers that may mislead someone into drinking from them.

Do not pour waste onto the ground, down a drain, or into any water source.

Air conditioning refrigerants escaping into the air can damage the Earth's atmosphere. Government regulations may require a certified air conditioning service center to recover and recycle used air conditioning refrigerants.

Inquire on the proper way to recycle or dispose of waste from your local environmental or recycling center, or from your dealer.

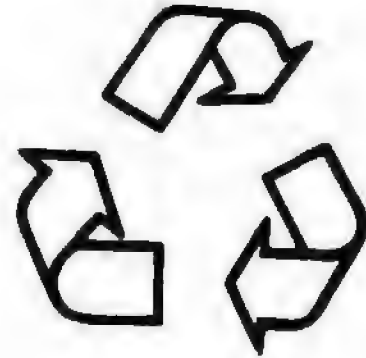

WORK IN VENTILATED AREA

Engine exhaust fumes can cause illness or death. If it is necessary to run an engine in an enclosed area, remove exhaust fumes from the area with an exhaust pipe extension.

If you do not have an exhaust pipe extension, open the doors and get outside air into the area.

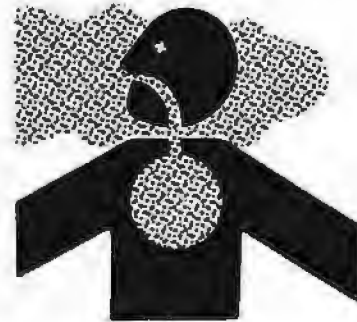

AVOID HEATING NEAR PRESSURIZED FLUID LINES

Flammable spray can be generated by heating near pressurized fluid lines, resulting in severe burns to yourself and bystanders. Do not heat by welding, soldering, or using a torch near pressurized fluid lines or other flammable materials. Pressurized lines can be accidentally cut when heat goes beyond the immediate flame area.

Never weld or cut on a hydraulic oil tank or a structural member used as a hydraulic oil reservoir.



REMOVE PAINT BEFORE WELDING OR HEATING

Avoid potentially toxic fumes or dust.

Hazardous fumes can be generated when paint is heated by welding, soldering, or using a torch.

Remove paint before heating:

- Remove paint a minimum of 101 mm (4 in.) from area to be affected by heating. If paint cannot be removed, wear an approved respirator before heating or welding.
- If you sand or grind paint, avoid breathing the dust. Wear an approved respirator.
- If you use solvent or paint stripper, remove stripper with soap and water before welding. Remove solvent or paint stripper containers and other flammable material from area. Allow fumes to disperse at least 15 minutes before welding or heating.

Do not use chlorinated solvent in areas where welding will take place.

Do all work in an area that is well ventilated to carry toxic fumes and dust away.

Dispose of paint and solvent properly.

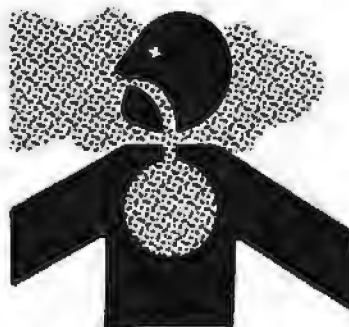

USE PROPER LIFTING EQUIPMENT

Lifting heavy components incorrectly can cause severe injury or machine damage.

Follow recommended procedure for removal and installation of components in the manual.



USE PROPER TOOLS

Use tools appropriate to the work. Makeshift tools and procedures can create safety hazards.

Use power tools only to loosen threaded parts and fasteners.

For loosening and tightening hardware, use the correct size tools. DO NOT use U.S. measurement tools on metric fasteners or metric tools on U.S. measurement fasteners. Avoid bodily injury caused by slipping wrenches.

Use only service parts meeting manufacturer specifications.



PROTECT AGAINST HIGH PRESSURE SPRAY

Spray from high pressure nozzles can penetrate the skin and cause serious injury. Keep spray from contacting hands or body.

If an accident occurs, see a doctor immediately. Any high pressure spray injected into the skin must be surgically removed within a few hours or gangrene may result. Doctor's unfamiliar with this type of injury should reference a knowledgeable medical source.



Safety

STAY CLEAR OF ROTATING DRIVELINES

Entanglement in rotating driveline can cause serious injury or death.

Keep master shield and driveline shields in place at all times. Make sure rotating shields turn freely.

Wear close-fitting clothing. Stop the engine and be sure P.T.O. driveline is stopped before making adjustments, connections, or performing any type service on the engine or P.T.O.-driven equipment.



USE SAFETY LIGHTS AND DEVICES

Slow moving tractors, self-propelled equipment and towed implements or attachments can create a hazard when driven on public roads. They are difficult to see, especially at night. Avoid personal injury or death resulting from collision with a vehicle.

Flashing warning lights and turn signals are recommended whenever driving on public roads. To increase visibility, use the lights and devices provided with your machine. For some equipment, install extra flashing warning lights.

Be sure to observe local laws.

Keep safety items in good condition. Replace missing or damaged items.

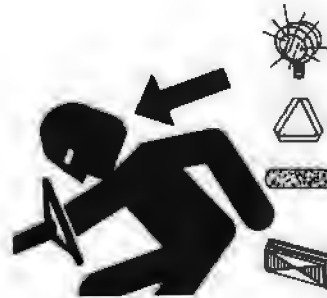

NO RIDERS

Never allow anyone to ride on the machine during operation or transport.



STAY CLEAR OF WIRES

Never fold or unfold wings near overhead wires.

During folding and when in the folded transport configuration, elements of the machine may be as high as:

12 Feet

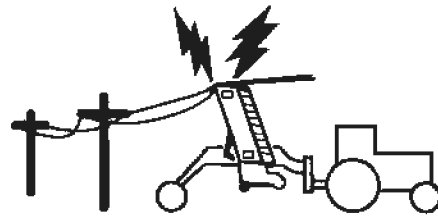

OBSERVE ALL TRAFFIC REGULATIONS

When traveling on public roads observe all traffic regulations in your area, especially the permissible transport dimensions.

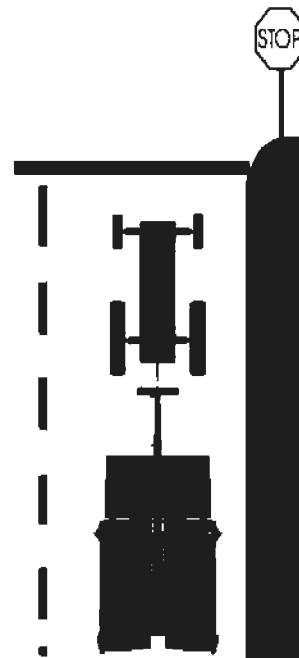

DRIVE AT SAFE SPEEDS

Always drive at speeds which allow complete control under existing field or road conditions.

Trailed implements influence the steering and braking performance of the tow vehicle. Make sure there is sufficient steering and brake capacity.

Use additional caution and reduce speed when towing under adverse surface conditions, when turning, and when on inclines.

OBSERVE MAXIMUM TRANSPORT SPEED

The maximum transport speed for this implement is:

- 20 mph (32 kph)

Some tractors are capable of operating at speeds that exceed the maximum transport speed of this implement. Regardless of the maximum speed capability of the tractor being used to tow this implement, do not exceed the implement's maximum transport speed.

Exceeding the implements maximum transport speed may result in:

- Loss of control of the tractor/implement.
- Reduced or no ability to stop during braking.
- Implement tire failure.
- Damage to the implement or tractor.
- Damage to the property of others.
- Personal injury or death.

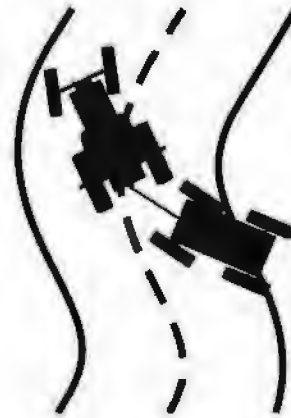

AVOID TIP-OVERS

Use a seat belt when available.

Avoid holes, ditches and obstructions which may cause the machine to tip, especially on hillsides.

Never drive near the edge of a ditch, creek, gully or steep embankment.

Slow down when turning or traveling over rough ground and when turning on hillsides.



KEEP CLEAR OF TINES

Keep clear of the working and danger areas around the machine.

Shut off machine before working on it. Use caution when working on moveable elements of the machine. There are numerous pinch and shearing points.

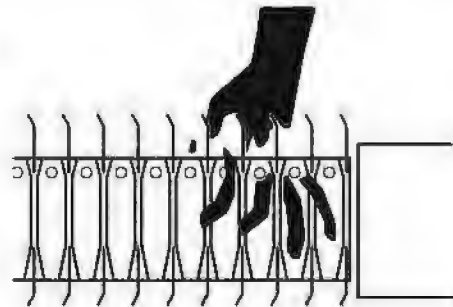

STAY CLEAR OF MACHINE

DO NOT step between the tractor and implement unless the machine is secured against unintentional movement by means of the parking brake or wheel chocks.



PLEASE NOTE:

In order to take the photographs required for this manual some of the shields and guards were removed. H&S Manufacturing does not recommend operating this equipment with any shields and guards removed. Make sure all shields and guards are securely fastened in place before operating this equipment.

CAP SCREW TORQUE VALUES

The specifications below are the torque values for fasteners as it adheres to the SAE torque value standards. All fasteners should be torqued to the proper values found in the figures below unless otherwise specified by the engineering drawing.

Lubed torque would be any fastener that has grease, liquid Loctite, oil, etc. on the threads.

Dry torque would be any fastener which has threads that are clean and dry and do not have any liquid Loctite or grease on them.

Hex Head Fasteners

The figure shown below shows how to determine what grade a fastener is.

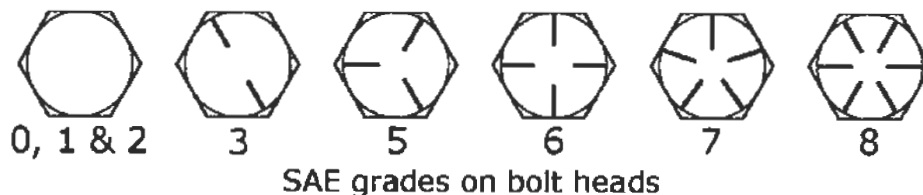

SUGGESTED ASSEMBLY TORQUE VALUES							WORKING TORQUE			
Diam & Thrds Per Inch	SAE GRADE 2 -6"		SAE GRADE 5		SAE GRADE 8		18-8 SS	316 SS	BRASS	SILICON BRONZE
	Dry FT. LB.	LUB FT. LB.	Dry FT. LB.	LUB FT. LB.	Dry FT.LB.	LUB FT LB.	IN LBS	IN LBS	IN LBS	IN LBS
1/4-20	5.5	4.2	8	6.3	12	9	75.2	78.8	61.5	68.6
1/4-28	6.3	4.7	10	7.2	14	10	94.0	99.0	77.0	87.0
5/16-18	11	8	17	13	24	18	132	138	107	123
5/16-24	12	9	19	14	27	20	142	147	116	131
3/8-16	20	15	30	23	45	35	236	247	192	219
3/8-24	23	17	35	25	50	35	259	271	212	240
7/16-14	32	24	50	35	70	50	376	393	317	349
7/16-20	36	27	55	40	80	60	400	418	327	371
1/2-13	50	35	75	55	110	80	517	542	422	480
1/2-20	55	40	85	65	120	90	541	565	443	502
9/16-12	70	55	110	80	150	110	682	713	558	632
9/16-18	80	60	120	90	170	130	752	787	615	697
5/8-11	100	75	150	110	210	160	1110	1160	907	1030
5/8-18	110	85	170	130	240	180	1244	1301	1016	1154
3/4-10	175	130	260	200	380	280	1530	1582	1249	1416
3/4-16	200	140	300	220	420	310	1490	1558	1220	1382
7/8-9	170	125	430	320	600	450	2328	2430	1905	2140
7/8-14	180	140	470	350	670	500	2318	2420	1895	2130
1-8	250	190	640	480	910	680	3440	3595	2815	3185
1-14	280	210	720	540	1020	760	3110	3250	2545	2885

HYDRAULIC FITTING TORQUE SPECIFICATIONS

Tapered Pipe Thread Size - Assembly turns from Finger Tight (TFFT) for Tapered Threads		TFFT
BSPT (Uncommon)	NPTF (Common)	
1/8-28	1/8-27	2 - 3
1/4-19	1/4-18	2 - 3
3/8-19	3/8-18	2 - 3
1/2-14	1/2-14	2 - 3
3/4-14	3/4-14	2 - 3
1-11	1-11 1/2	1.5 - 2.5
1 1/4-11	1 1/4-11 1/2	1.5 - 2.5
1 1/2-11	1 1/2-11 1/2	1.5 - 2.5
2-11	2-11 1/2	1.5 - 2.5



ORB - SAE J1926 Straight Thread Port Assembly Torques													
		Assembly Torque (+10% -0) **If fitting is being torqued into aluminum or brass, subtract 35% from standard torque value**											
		Non-Adjustable				Adjustable				Plugs			
		ORFS		JIC NPT		ORFS		JIC		Hollow Hex		Hex Head	
Dash Size	SAE Size (UN/UNF)	Ft. lbs. (In. lbs.)	Into Alum. Or Brass Ft. lbs. (in. lbs.)	Ft. lbs. (In. lbs.)	Into Alum. Or Brass Ft. lbs. (in. lbs.)	Ft. lbs. (In. lbs.)	Into Alum. Or Brass Ft. lbs. (in. lbs.)	Ft. lbs. (In. lbs.)	Into Alum. Or Brass Ft. lbs. (in. lbs.)	Ft. lbs. (In. lbs.)	Into Alum. Or Brass Ft. lbs. (in. lbs.)	Ft. lbs. (In. lbs.)	Into Alum. Or Brass Ft. lbs. (in. lbs.)
2	5/16-24	-	-	(85)	(55)	-	-	(60)	(39)	(30)	(19.5)	(85)	(55)
3	3/8-24	-	-	(155)	(101)	-	-	(100)	(65)	(55)	(36)	(155)	(101)
4	7/16-20	(310)	(201.5)	(260)	(169)	(180)	(117)	(180)	(117)	(120)	(78)	(260)	(169)
5	1/2-20	(360)	(234)	(280)	(182)	(360)	(234)	(250)	(162.5)	(170)	(110.5)	(280)	(182)
6	9/16-18	(420)	(283)	(350)	(227.5)	(420)	(273)	(350)	(227.5)	(410)	(266.5)	(350)	(175)
8	3/4-16	60	39	(620)	(403)	60	39	(620)	(217)	60	39	(620)	(403)
10	7/8-14	100	65	85	55	100	65	85	55.25	100	65	85	55
12	1 1/16-12	135	88	135	88	135	88	135	88	135	88	135	88
14	1 3/16-12	175	114	175	114	175	114	175	114	175	114	175	114
16	1 5/16-12	200	130	200	130	200	130	200	130	200	130	200	130
20	1 5/8-12	250	162.5	250	162.5	250	162.5	250	162.5	250	162.5	250	162.5
24	1 7/8-12	305	198	305	198	305	198	305	198	305	198	305	198
32	2 1/2-12	375	244	375	244	375	244	375	244	375	244	375	244

HYDRAULIC FITTING TORQUE SPECIFICATIONS

Code 61 and 62 Flange Recommended Bolt Torques

Steps to Properly Assemble the Flange Port Clamping Bolts:

1. Inspect components to ensure that male and female port threads and sealing surfaces are free of burrs, nicks and scratches, or any foreign material.
2. Lubricate the O-ring
3. Position flange and clamp halves
4. Place lock washers on bolts and insert through clamp halves
5. Hand tighten bolts.
6. Torque bolts in diagonal sequence in small increments to the appropriate torque level **refer to the table below.

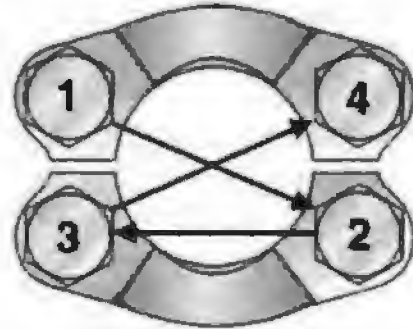

Flange Bolt Tightening Sequence

Code 61						Code 62					
Dash Size	Flange Size	Inch Bolt (SAE J518)	Torque ft. lbs.	Metric Bolt (ISO 6162)	Torque N-m	Dash Size	Flange Size	Inch Bolt (SAE J518)	Torque ft. lbs.	Metric Bolt (ISO 6162)	Torque N-m
8	1/2	5/16-18	17 ± 2	M8	24	8	1/2	5/16-18	17 ± 2	M8	24
12	3/4	3/8-16	31	M10	50	12	3/4	3/8-16	31	M10	50
16	1	3/8-16	31 ± 4.5	M10	50	16	1	7/16-14	52	M12	92
20	1-1/4	7/16-14	52	M12	50	20	1-1/4	1/2-13	77	M14	130
24	1-1/2	1/2-13	77	M12	92	24	1-1/2	5/8-11	155	M16	210
32	2	1/2-13	77	M12	92	32	2	3/4-10	265	M20	400
40	2-1/2	1/2-13	77	M12	92						
48	3	5/8-11	155	M16	210						
56	3-1/2	5/8-11	155	M16	210						
64	4	5/8-11	155	M16	210						
80	5	5/8-11	155	M16	210						

37° Flare (JIC) Assembly Torques and FFWR					
SAE Dash Size	Thread Size	Assembly Torque (+10%-0)		Tube Connection FFWR	Swivel Nut or Hose Connection FFWR
		In. lb.	ft. lb.		
-2	5/16-24	35	3	-	-
-3	3/8-24	65	5	-	-
-4	7/16-20	155	13	2 1/2	2
-5	1/2-20	165	14	2	2
-6	9/16-18	265	22	2	1 1/2
-8	5/8-16	505	42	2	1 1/2
-10	7/8-14	720	60	1 1/2	1 1/2
-12	1 1/16-12	1000	84	1 1/2	1 1/4
-14	1 3/16-12	1200	100	1 1/2	1 1/4
-16	1 5/16-12	1415	118	1 1/2	1
-20	1 5/8-12	2015	168	1	1
-24	1 7/8-12	2340	195	1	1
-32	2 1/4-12	3180	265	1	1
-40	3-12	-	-	1	1

QUICK START GUIDE

Hooking up the Merger

1. When connecting to the tractor raise the hitch just far enough to get jack stand swung up into transport position. This puts the tractors two point at the proper operating height.
2. Once you are hooked to the two point then hook up PTO. There are two different length PTOs for both 1-3/8 and 1-3/4 shaft size. Make sure you have the proper overlap. (At least 3 inch where both shafts are engaged)
3. Next plug in ISOBUS harness to tractor ISOBUS port located on rear of tractor. (IF tractor is not equipped with tractor ISOBUS port you will need to buy and aftermarket adapter to power control box).
4. If you don't have Auxiliary N ISOBUS on tractor (Generally 2016 or newer) you will need to install the control box in the cab.
5. Next plug in light cord which runs the taillights.
6. Now you are ready to run the merger

Operating up the Merger

1. Refer to Operators manual on how to unfold/ fold and operate the merger. There will be two different sections in the operator's manual one for the ISOBUS and one section for optional control box.
2. When you have the merger folded down in operating position you will need to rephase the skid shoes to make sure they are all at the correct height. You can do this by holding the button and lowering them to the ground. Once there are on the ground keep holding the button down for 30 seconds this will rephase the cylinders so that they are all the same height. Now you are ready to go and merge.
3. The following is a chart to get you an idea where to run machine for crop conditions. (You will need to fine tune merger for your crop and field conditions):

Starting and Stopping the PTO

When starting or stopping the PTO The merger and tractor need to be in line or this can cause misalignment

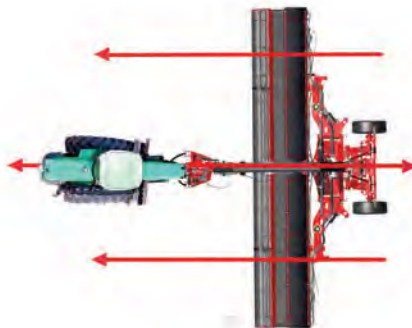

SET-UP & ASSEMBLY

NOTE: Determine right or left side of the Merger by viewing it from the rear. If instructions or parts lists call for hardened bolts, refer to Cap Screw Torque Values chart.

- Check the Merger for proper assembly and adjustment. Make sure that all bolts are tightened.
- Securely retighten after a few hours of operation as bolts can loosen up on new machinery.
- Lubricate the Merger completely (Refer to the Lubrication section in this Manual).



If the merger was shipped w/o the rims/tire assemblies attached, Attached the rims/ tire assemblies, using the lug nuts furnished. Torque the mounting hardware to the correct torque specification. Check the wheel bolts periodically there after.

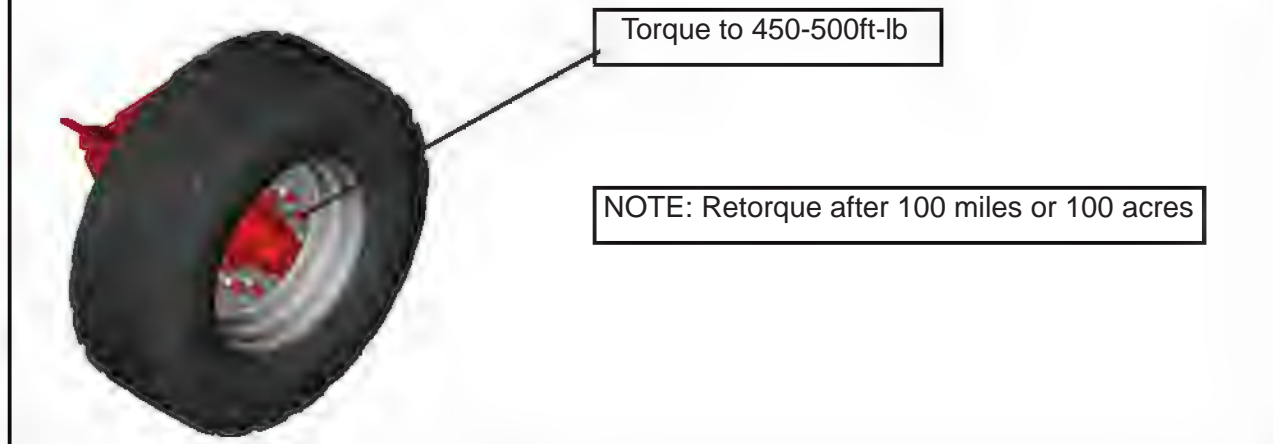

Check tire and inflate to the recommended pressure. (385/65 R22.5)

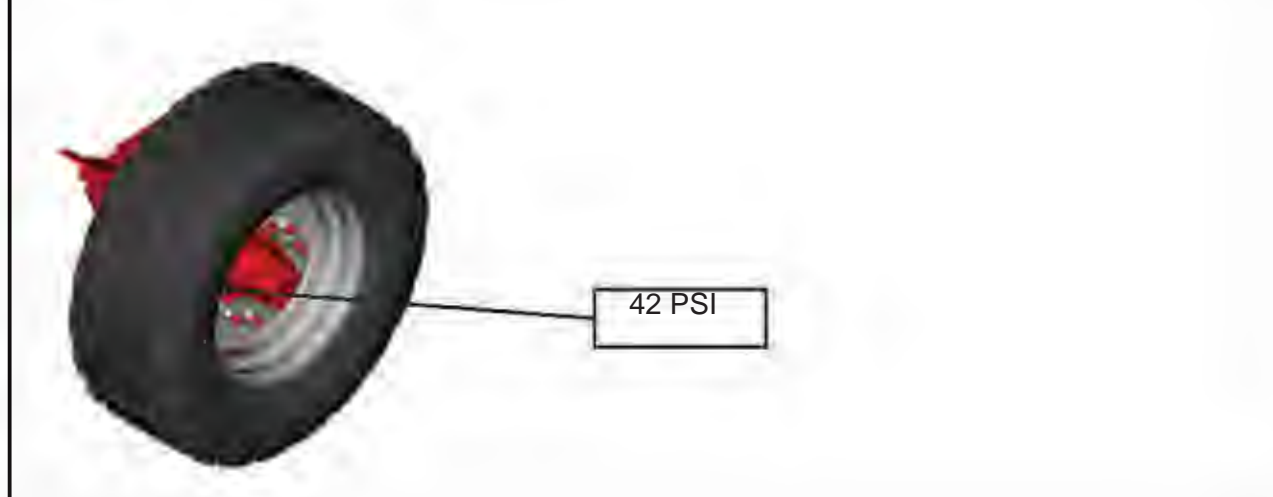

MACHINE PREP & OPERATION

TRACTOR REQUIREMENTS

There are several requirements the tractor must have to ensure efficient operation of the Merger.

1. The tractor must be equipped with a 7-pin connector for proper transport and warning light function.
2. The tractor must be equipped with a 1000 RPM 1-3/8" 21 spline or 1-3/4" 20 spline PTO.
3. The tractor must be equipped with a category 2, 3N or 3 three point hitch (Quick Hitch would be most desirable).
4. The tractor must also be equipped with a 3-pin convenience outlet that is operated by tractor keyed power or keyed power. Note: optional display harness may come with this, but it is not needed.
5. The Merger requires a minimum 150 H.P. tractor, **AND** that has a minimum tractor weight of 12,000 lbs.
6. Iso Requirements - must have rear facing ISOBUS breakaway.
Auxillary Iso-Bus
Optional Display

MAIN TRACTOR PLUG

1. Black (Ground)
2. Red (Work Lights)
3. Yellow (Left Turn)
4. Not Used
5. Green (Right Turn)
6. Brown (Tail Lights)
7. Not Used

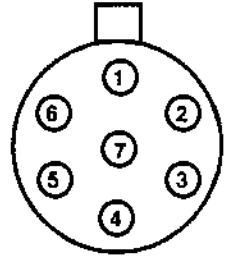

Tractor wiring may differ. Check your tractor manufacturers' electrical diagram to match to the Merger's wiring.

ISOBUS

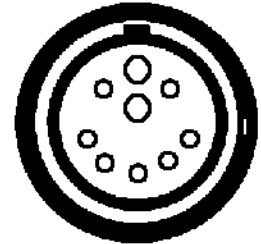

TRACTOR HOOK UP

3-Point

Raise the 3-point hitch just until the jack stand can be swung into the transport position, the 3-point is now at the proper operating height. Correct hitch distance from ground to center of pins is 24" to 26". If the tractor is equipped with a quick coupler make sure the latches are engaged.

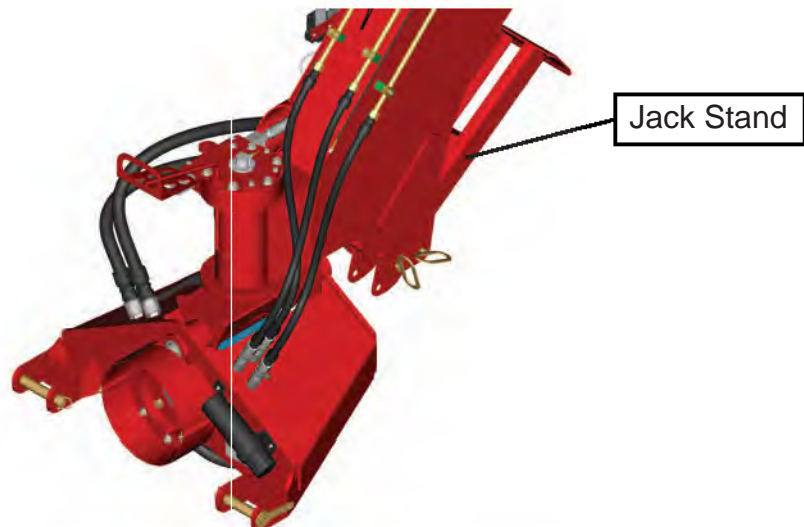

MACHINE PREP & OPERATION

PTO

- The PTO is a direct drive system to the pump.
- Configure the proper PTO length and spline needed for the tractor. Using the two set screws supplied with PTO, connect the PTO shaft to the pump input shaft. The top PTO shield swings back with removal of driver side pin for easy access to PTO set screws. Replace the PTO shield before using the machine.
- Slide the spring loaded locking collar on the PTO yoke rearward and slide the yoke onto the tractor PTO shaft. Release spring loaded collar. Be sure the pins fall into the groove on the tractor PTO shaft and collar snaps forward into position. **CAUTION:** Do not use a steel hammer to aid in joining PTO parts.



**PTO operating speed may vary from from 700 to 1000 RPM
depending on the crop that is being merged**

WARNING: DO NOT RUN THE CROSS-CONVEYOR BELTS WHEN THE *TWIN-FLEX* MERGER IS IN THE TRANSPORT POSITION AS DAMAGE WILL OCCUR WHEN THE BELTS ARE RUN OFF OF CENTER!

Steering Settings

Place a ½” bolt thru the pole hitch location directly over the hitch pivot hole at the very front of the merger to verify center at the hitch. Remove the wires from SV3 and SV4 coils to prevent the computer from compensating the system. Pull the merger outside in the stored position with the PTO on to activate the steering and start making some turns left and right. This will take some time before the air will work its way out of the system. If dog tracking make adjustments to the master cylinder in the front to get the steering to return back to center after a turn. Make 2-1/2 turn into the steering rack from the starting point to get the merger to “center” after a full turn, Lock the jam nut at the master/rack position. Hook CV3 and CV4 back up. Manually override the CV3 valve making the rear axle turn. The axle should at some point stop turning and then return back to center +/- 1/8.” If the axle continues to move all the way to lock, swap CV3 and CV4 wires and repeat test.

MACHINE PREP & OPERATION

TOWING ON THE HIGHWAY

Follow state and local regulations when towing farm equipment on public highways. Never tow the Windrow Merger on a public highway at a speed greater than 20 m.p.h. (32 kph).

1. Before folding, clean excess mud and field debris from the merger.
2. Raise conveyors into the transport position.
3. P.T.O. shaft is properly attached to tractor.
4. Hitch Pins are secured
5. All lights required for road travel are in good working condition and visible.
6. SMV sign is attached.

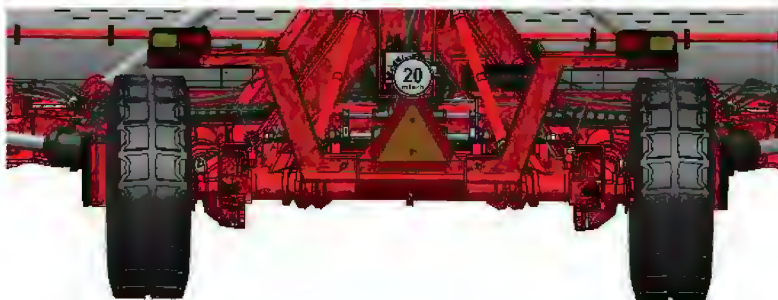

MACHINE PREP & OPERATION

Fuse Functions

Top Fuse Block

Fuse #1- 5 amp

- PLC Power

Fuse #2 – 15

- Soft shoe pressure sensor
- Soft shoe lower pressure
- Skid shoe height sensor
- Optional In cab display
- Right head belt direction
- Right head belt off
- Right head reel speed
- Right head transport sensor

Fuse #3 – 5 Amp

- PLC Power

Fuse # 4 – 15 amp

- Left unfold main line pressure sensor PT1
- Left head unfold
- Left head fold
- Right head lift cylinder unlock SV3
- Left head float pressure sensor B2
- Soft shoe add pressure SV1
- Left head manifold SV1
- Left head manifold CV3

Bottom Fuse Block

Fuse #6 – 15 amp

- Wheel speed sensor
- Rear steering sensor
- Steering corrections SV3 and SV4
- Skid shoe raise and lower SV1A and SV1B
- Right head float sensor B2
- Right head main line pressure PT1

Fuse #5- 15 amp

- Left head belt direction
- Left head belt off
- Left head reel speed
- Left head transport sensor

Fuse #3 – 15 amp

- Right head unfold
- Right head fold
- Left head lift cylinder unlock SV3
- Right head manifold SV1
- Right head manifold CV3

Fuse #1 – 5 amp

- PLC power

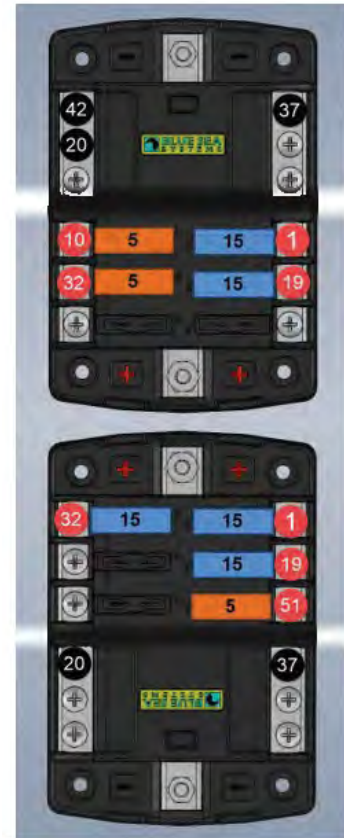

SOFT SHOE™ SUSPENSION SYSTEM

The H&S **SOFT SHOE™** Suspension System is a self-contained hydraulic suspension system that provides the softest merger head footprint in the industry! This is important in many field conditions...wet soils, rough terrain, new seeding, etc.

The **SOFT SHOE™** Suspension System incorporates an additional pump section to the PTO pump assembly, along with computer-controlled logic that self-regulates the nitrogen-charged accumulator head suspension system pressure. The operator controls the desired head suspension system pressure from the remotely-mounted display console. Excess oil from the pump is diverted back to tank through the solenoid manifold assembly. When operator chooses to increase the head suspension system pressure, this reduces the skid shoe weight in the field. Oil is diverted from the accumulator to the two head lift cylinders to “lift” the heads thereby decreasing the amount of weight on the skid shoes. If the operator chooses to decrease the head suspension system pressure, this has the effect of adding skid shoe weight in the field. When this happens, oil is “bled” from the two head lift cylinders which increases the weight of the heads on the skid shoes.

As the merger is operating through the field, the H&S **SOFT SHOE™** Suspension System provides a self-regulating feature that constantly adjusts the weight on the skid shoes. This is accomplished with the computer-controlled logic that constantly senses the hydraulic pressure fluctuations that come with the constant changes in field environments, especially rolling and rough ground conditions. The computer-controlled logic send signals to control manifold solenoids and can do so at a rate of up to 125 signals per second.

What you end up with is a self-monitoring weight transfer system that maintains a constant system pressure throughout the entire 20” of header travel. The H&S **SOFT SHOE™** Suspension System delivers a footprint that reduces field damage from head scuffing and minimizes wear on the skid shoes.

Belts Left



Belts Off



Belts On



Belts Right



Belts Spilt



Both Heads Down



Both Heads Up



Left Head Down



Left Head UP



Right Head Down



Right Head Up



Shoe Down

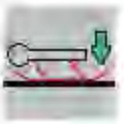

Shoe Up



ISO-BUS DISPLAY

Use to pull up page

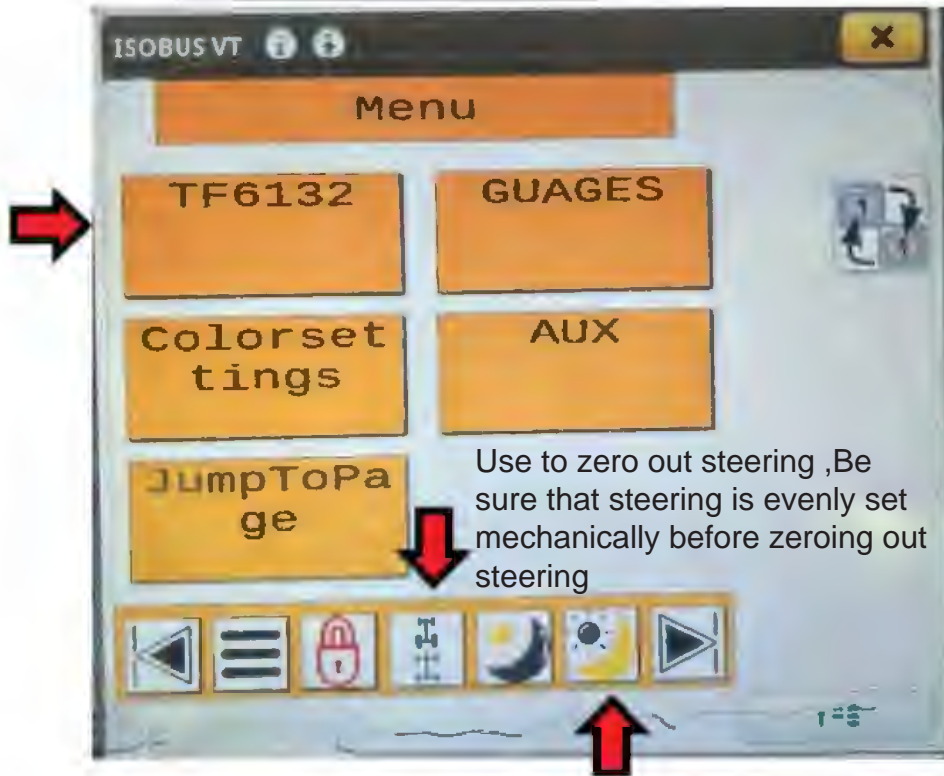

Use to zero out steering ,Be sure that steering is evenly set mechanically before zeroing out steering

Select to enter night-time display mode

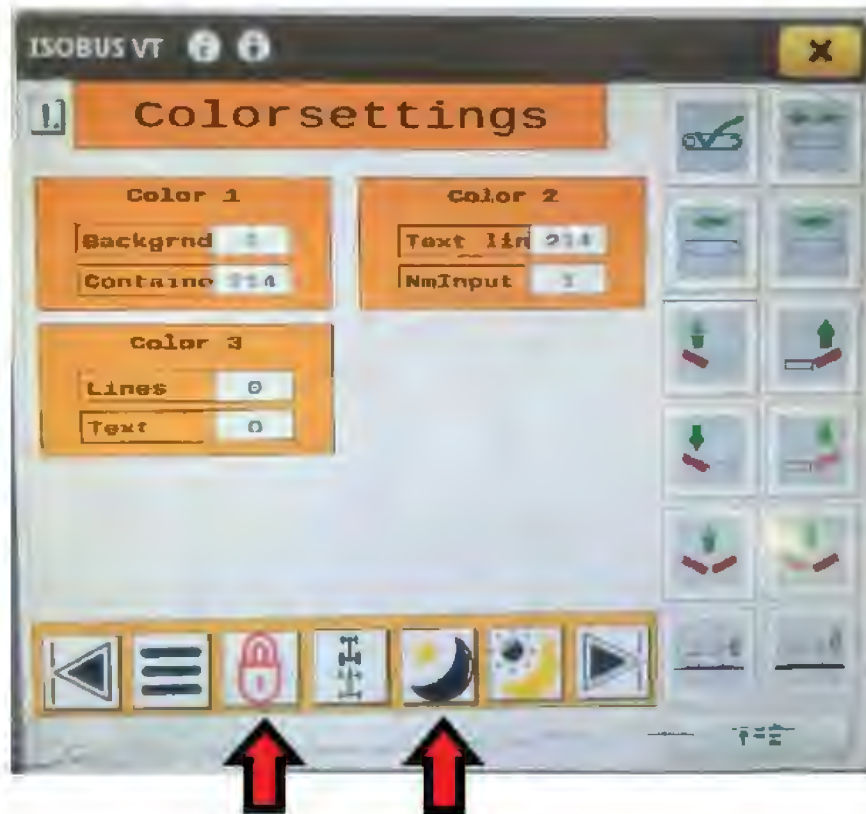

Use the lock to lock in the color scheme

Use to use Day time display mode

ISO-BUS DISPLAY

ISOBUS VT TF6132

FLOAT: 542 PSI
 REEL SPEED: 100 %
 HEAD HEIGHT: 2.40 INCHES
 ACRES L, ACRES R

Spilt Belts
 Right Direction
 Right head up
 Right head down
 Unfold the merger completely
 Lower Skid Shoes

ISOBUS VT TF6132

FLOAT: 542 PSI
 REEL SPEED: 100 %
 HEAD HEIGHT: 2.40 INCHES
 ACRES L, ACRES R

Belts on
 Left Direction
 Left head up
 Left head down
 Fold the merger completely
 Raise Skid Shoes

ISO-BUS DISPLAY

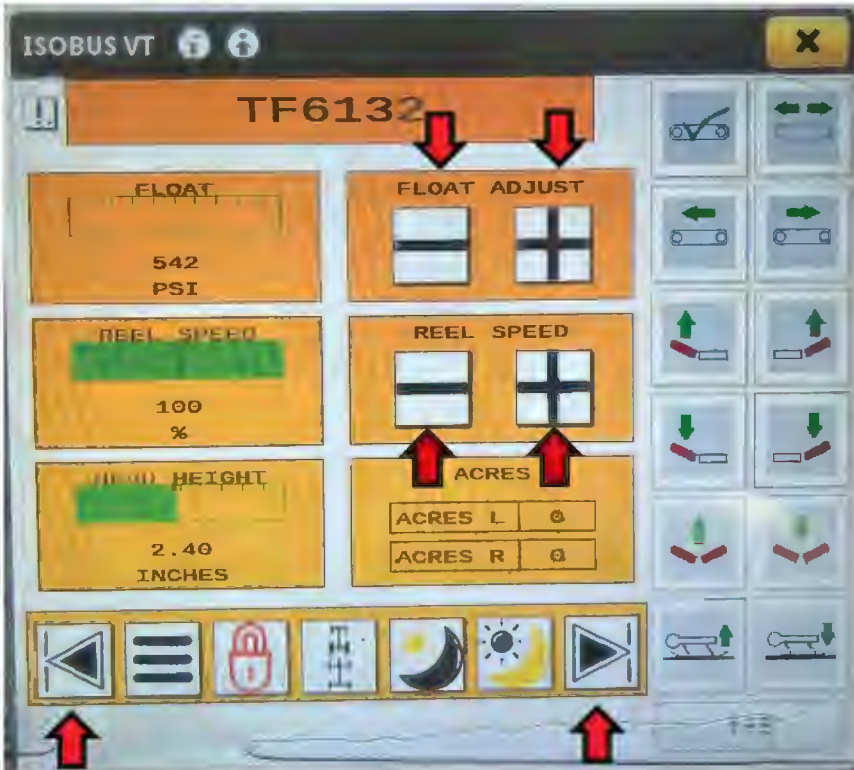

The Black Lines on the Float Is the Target Pressure. The Black Line On The Height Does Not Move, The Green Bar Should Be Above The Black Line.

The Plus and Minus under float adjust are used to raise and lower float pressure

The Plus and Minus under Reel Speed are used to raise and lower reel speed

The left and right arrow keys are used to navigate to the home screen

NOTE: IF the Float pressure is too high the merger head can raise off the ground when Merging.

If the Float Pressure is too low it can cause more field scuffing or merger damage



Use left and right arrows to check your aux screen

ISO-BUS DISPLAY

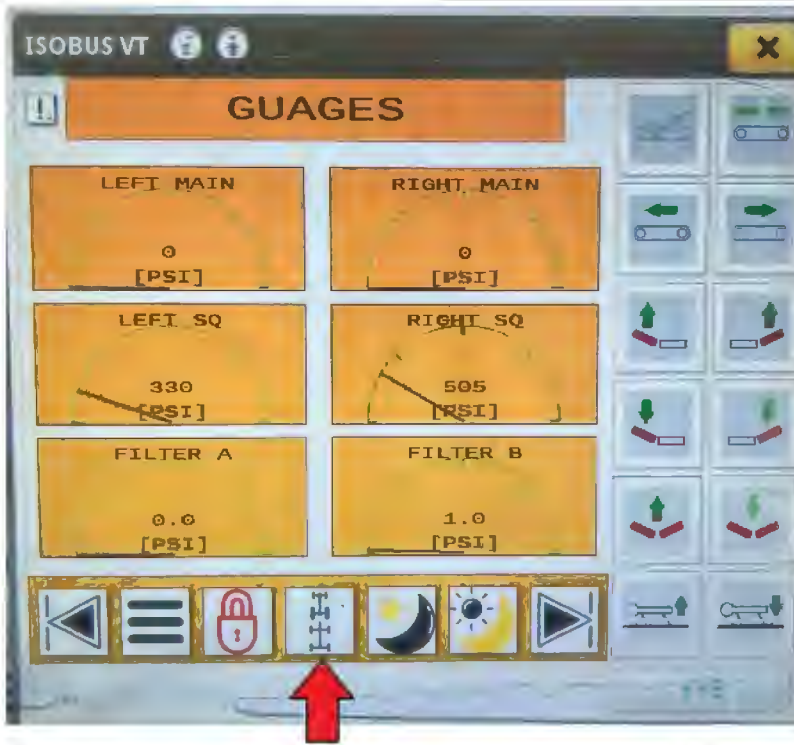

Main Pressure needs to spike at 2000 PSI for 2 seconds to Float

Sequence Pressure needs to be above 300PSI to float

These are the return line pressure guages. This will give you an error

Use The Left and Right arrows to check Pressure Guages

Select and hold for 10 seconds to zero out steering.
Be sure that steering is evenly set mechanically before zeroing out steering. Verify that there is a check mark symbol to signal steering has been zeroed.



Use Right and Left arrows to get to Jump to page.
Click page number you are looking for

CAN-BUS DISPLAY

Both **HEADS**
folding **UP** at the
same time



NOTE: When folding the heads up hold both buttons.



Head Height
UP and **DOWN**

CAN-BUS DISPLAY

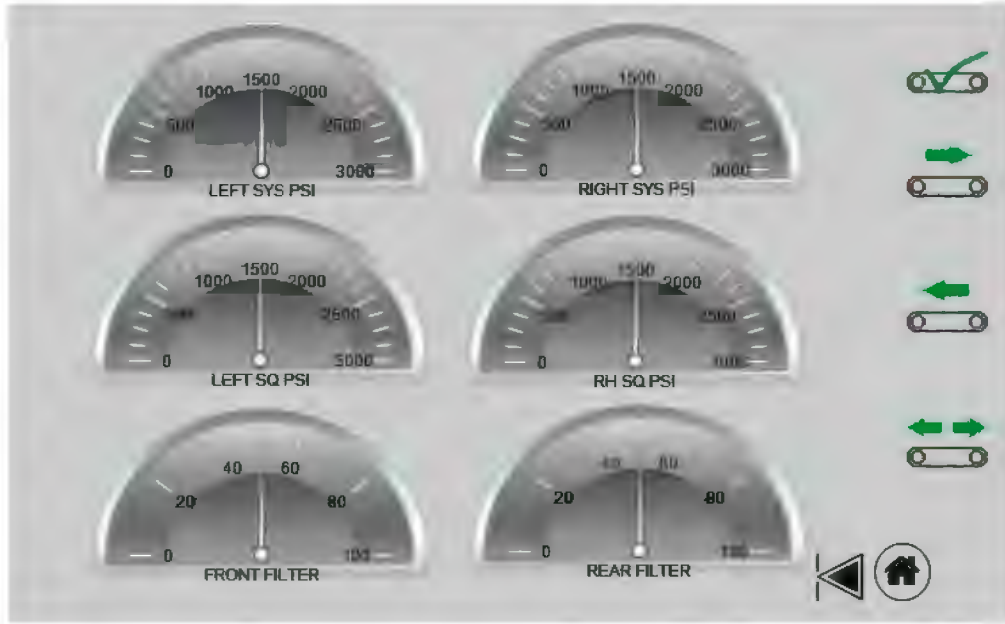

Diagnostic's



Pressure

Pick up Speed

Home Screen

NOTE: If you run too much float pressure the head may not drop to the ground when unfolding.

If you run not enough float pressure the heads could have a gap in between and could leave hay.

ADJUSTMENTS

ACCUMULATOR

Releasing Accumulator Pressure

WARNING!

When making adjustments, the machine will see the new parameter and adjust the machine appropriately. This may cause the machine to move in the direction of the new parameter.

- Ensure that everyone is clear of the machine when making adjustments.
- Ensure that everyone is clear when working on, operating, or moving the Merger.
- When working on high pressure hydraulic circuits, the oil can be under pressure and cut through the skin.

WARNING!

PRESSURE MUST BE BLED FROM THE ACCUMULATOR BEFORE REPAIRING OR REMOVING IT.

1. Remove the **VALVE GUARD & VALVE CAP** as shown in the first picture below.
2. Attach the **GAUGE** to the **VALVE STEM** and turn in the **VALVE THUMB SCREW** to bleed the pressure from the **ACCUMULATOR** as shown in the second picture below.

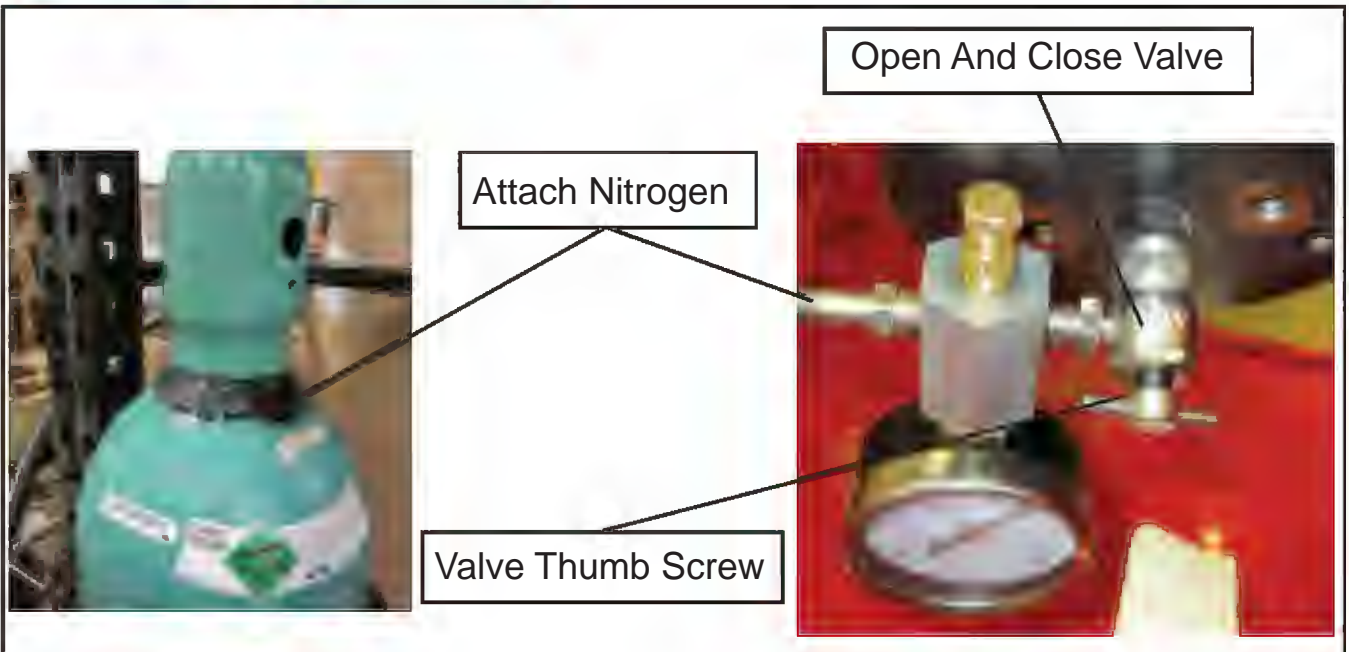
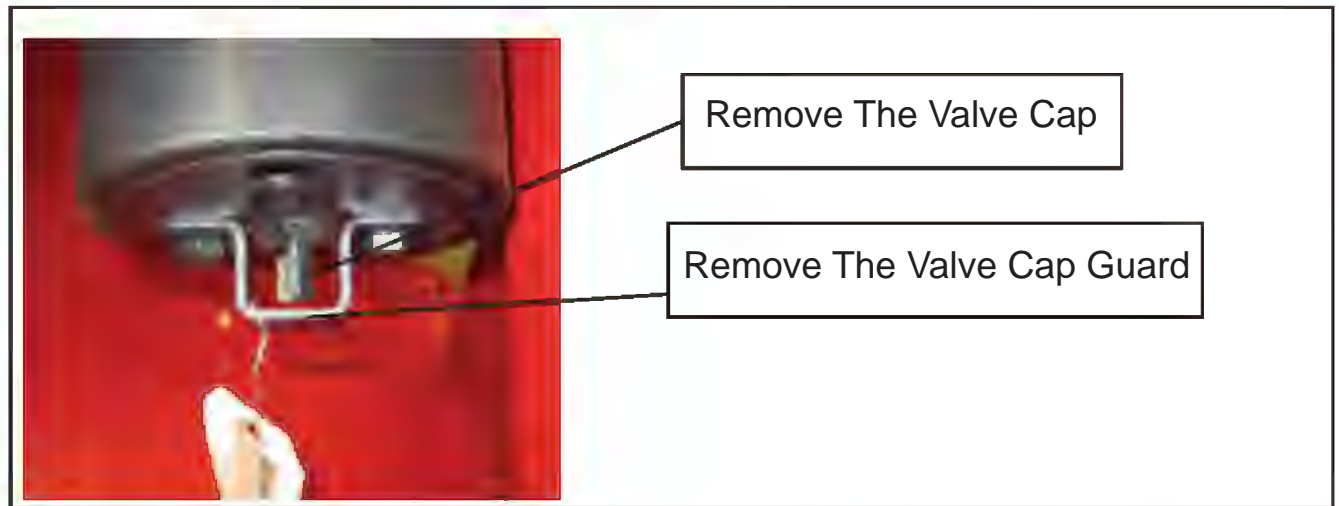

ADJUSTMENTS

To recharge **ACCUMULATOR(S) By A Qualified Professional Or Dealer**, remove **VALVE GUARD** and **VALVE CAP**. Attach Gauge to VALVE STEM (make sure the Valve Thumb Screw is turned out all the way (closed) before attaching). Connect Nitrogen Tank to Gauge inlet. Turn in the Valve Thumb Screw on the Gauge to open the Valve. Open the Valve on the Nitrogen tank to fill the **ACCUMULATOR(S)** to the pressure to 350PSI. Close the Nitrogen Tank Valve and turn the Gauge Valve Thumb Screw all the way out to close it then disconnect the Nitrogen Tank and the Gauge.

Make sure to reattach the valve guard and valve cap.

ADJUSTMENTS

PICKUP SPEED

The pick up speed is adjustable using the manifold on the back of each head. In light crops an operator can slow the pick up speed down while maintaining belt speed. (note lowering PTO rpm will slow both the belt and the pick up reel). Pickup speed may also be adjusted on the touch screen in the cab.

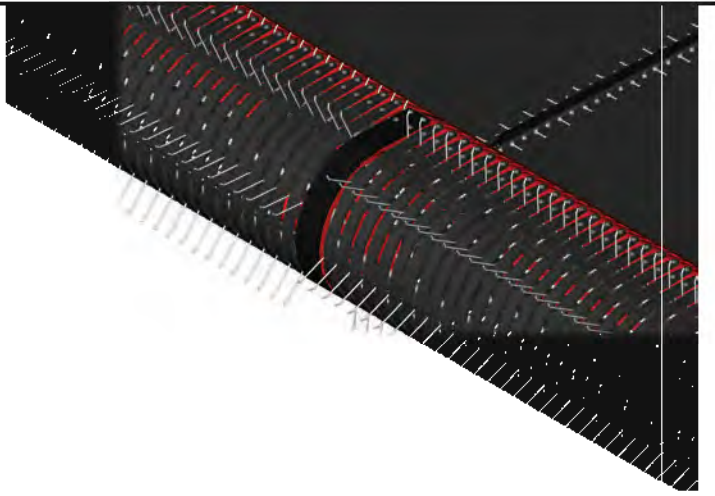

CROSS CONVEYOR SPEED

The cross conveyor speed on the Merger can only be changed by varying the tractor PTO speed. The speed relationship between the pickup and the cross conveyor is preset for an all around optimum performance level.



ADJUSTMENTS

CROSS CONVEYOR BELT ADJUSTMENT

NOTE: Cross conveyor belts should be checked for correct tracking frequently in the first 300 acres, then daily thereafter.

To adjust belt tracking;

1. Slightly loosen the 4 bolts (A).
2. Adjust the jam nuts either way to set the belt tracking (B).
3. Tighten the 4 bolts (A) after the belt tracking is set.

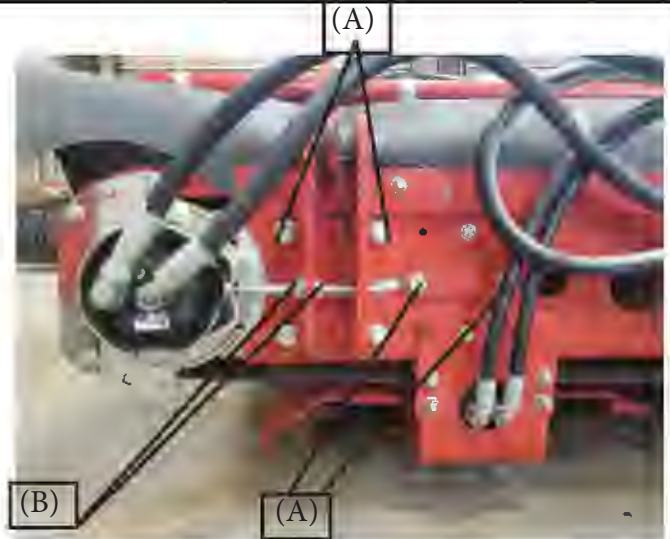

The center adjustments are set at 2 7/8" to square up the center roller.

The outer adjustment starts at 2 7/8", then it is moved to adjust belt tracking. If the belt is tracking rearward, the roller needs to be adjusted out. If the belt is tracking forward, the roller needs to be moved in.

It is easier to adjust one belt at a time with the opposite head in the transport position. When a belt is tracking properly, the center groove will ride in the notch in the roller and the belt will have an audible hum/buzz to it. Be sure to run the belt in both directions with the PTO at 1000 RPM to ensure proper tracking.

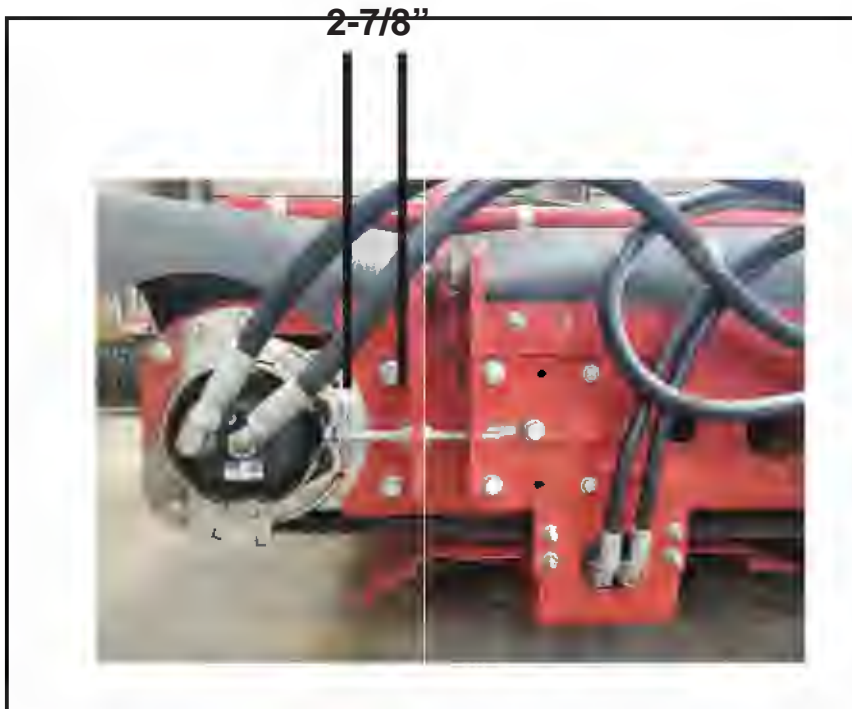

SERVICE

DAILY SERVICE

Cleaning

It is a good practice to clean the entire merger at the end of each day. Getting the chaff and crop off the merger when dry will save the appearance and finish of the merger. It also gives the operator a chance to check the machine up close to keep it operating properly. Before starting to merge each day, make sure to check for crop build-up under the cross conveyor belts and cross conveyor rollers. This is easily accomplished while the merger is in the transport position. If there is build-up it must be removed prior to operation or it could cause cross conveyor belt failure. The best way to do this is with forced air pressure.

Skid Shoes

Clean out the skid shoes at least once a day when the merger is in the transport position. They can become packed with debris and dirt during normal operation. Cleaning is very important for proper skid shoe operation.



Pickups & Hay Strippers

Check the pickup teeth and hay strippers daily that none were broken or damaged by field obstructions to ensure proper field performance.



Oil Fill & Check Plugs

Check the oil level daily by the “Cold Level Check Plug”. If oil cannot be seen at the Cold Level, remove the hydraulic oil fill cap and add oil until oil begins coming out of the cold level check. Note the cap vents at 5 psi so there may be some air pressure when removing the cap.

Note: Belts will shut off when max hot oil of 220 is reached.

120 or higher, check hot fill, 120 or below check cold level..

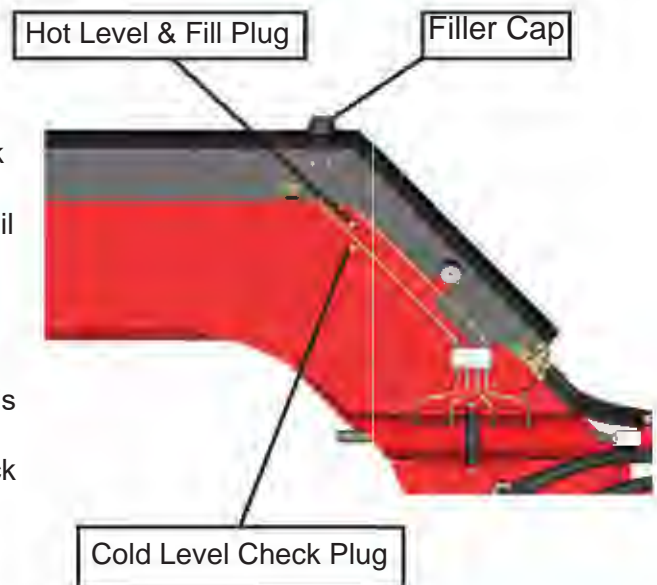

SERVICE

ANNUAL SERVICE

Cam Bearings

Depending on the acres per year, and field conditions, the cam bearing should be inspected annually for wear and replaced when the outer bearing surface no longer has a taper and has become flat or the diameter is 1.95" (1 15/16") or less. Cam bearings can be replaced without removing the tine bar by using the access port designed into the center drive gearbox.

Wear Bearing



New Bearing



Tine Bar Bearing

Tine bar bearings should be inspected annually for wear and replaced when there is 3/16" of up and down movement on the tine bar. The 2 piece design of the tine bar bearing allows them to be easily changed without removing the tine bar. The inner steel sleeve should be replaced after the 2 piece nylon bearing has been replaced twice.



Cross Conveyor Belts

The cross conveyor belts should all be removed at the end of each season and the inner frame work thoroughly cleaned of build-up and debris. This will ensure proper operation the next season.



SERVICE

ANNUAL SERVICE

Oil Filter

The hydraulic oil filter should be changed at least once a year or prior if filter becomes clogged during the season.

To change the filter; remove fill cap and then:

1. Unscrew the filter cover. Located on the of the tank
2. Carefully remove & discard the used filter cartridge.
3. Insert the new oil filter cartridge.
4. Replace filter cover.

Head GearBoxes

Each pickup is powered by a gearbox in the center of the head.

Each center cam gearbox uses 26 ounces of SAE 30W motor oil. The oil in each gearbox should be checked before each crop and changed on an annual basis.

Oil is drained by removing the lower cover. This is accomplished by removing the 4 bolts (A).

When reinstalling cover, inspect the O-ring (PN 82330) for damage and replace as necessary. Ensure that the O-ring is properly seated in its groove when replacing the cover.

Add oil and check at the fill plug (B)

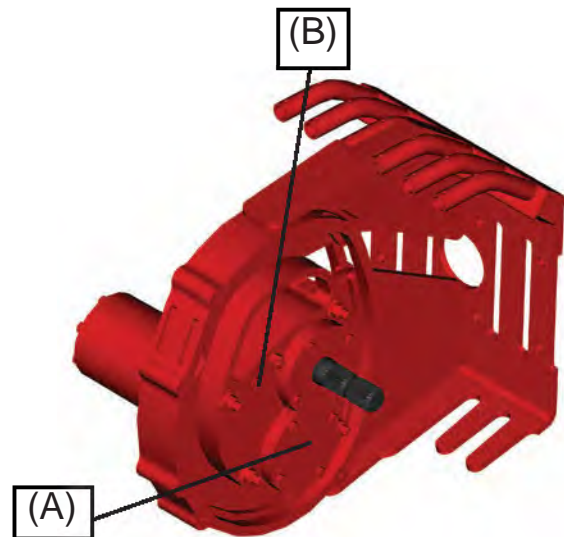

HOSES

HYDRAULIC HOSES

All hydraulic hoses should be inspected for damage and wear once a year or every 350 hours.
All worn and damaged hoses should be replaced.



WARNING: HYDRAULIC FLUID ESCAPING UNDER PRESSURE CAN PENETRATE THE SKIN, CAUSING SERIOUS INJURY. IF ANY FLUID IS ACCIDENTALLY INJECTED UNDER THE SKIN, IT MUST BE SURGICALLY REMOVED BY A DOCTOR WITHIN A FEW HOURS OR GANGRENE CAN RESULT. DOCTORS UNFAMILIAR WITH THIS TYPE OF INJURY SHOULD REFERENCE A KNOWLEDGEABLE MEDICAL SOURCE.



HOSE REPLACEMENTS

All hose replacements can be found in the TF6132 Parts Book on the H&S Portal and can be obtained by contacting your local H&S dealer.

BLOCKAGES

Product flow blockage can occur in any of the conveyors. The blockage will need to be cleared before harvesting can continue.



WARNING: NEVER CLEAR BLOCKAGES WHILE MACHINE IS RUNNING. TRACTOR ENGINE MUST BE OFF. FAILURE TO DO SO CAN CAUSE PERSONAL INJURY OR DEATH.



It may be possible to clear a conveyor blockage by re-versing the conveyor. However, it may be necessary to clear the blockage manually.

Be sure to replace all guards and covers that were re-moved while clearing blockages.

OPTIONS

TFOICC IN CAB DISPLAY



Mount in Cab

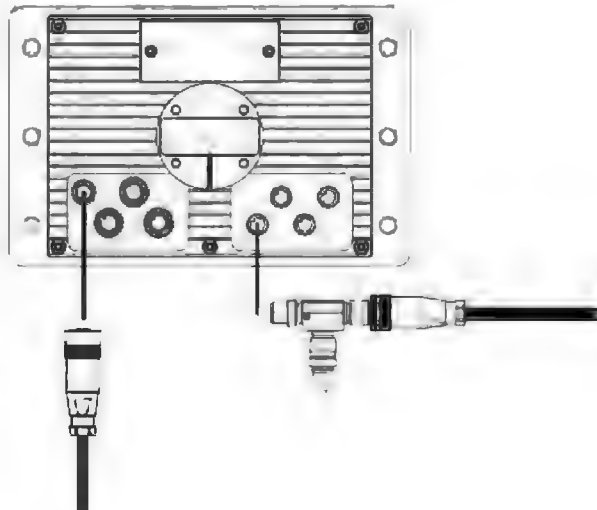

OPTIONS

1-3/8" 1000 RPM Standard Length PTO

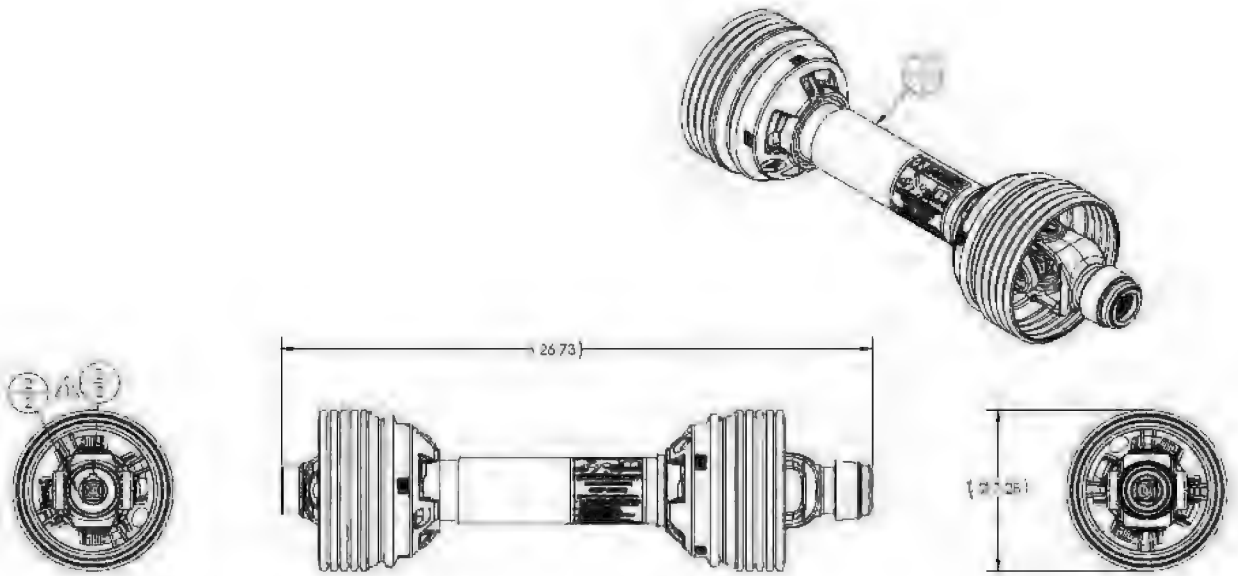

1-3/8" 1000 RPM Long Length PTO

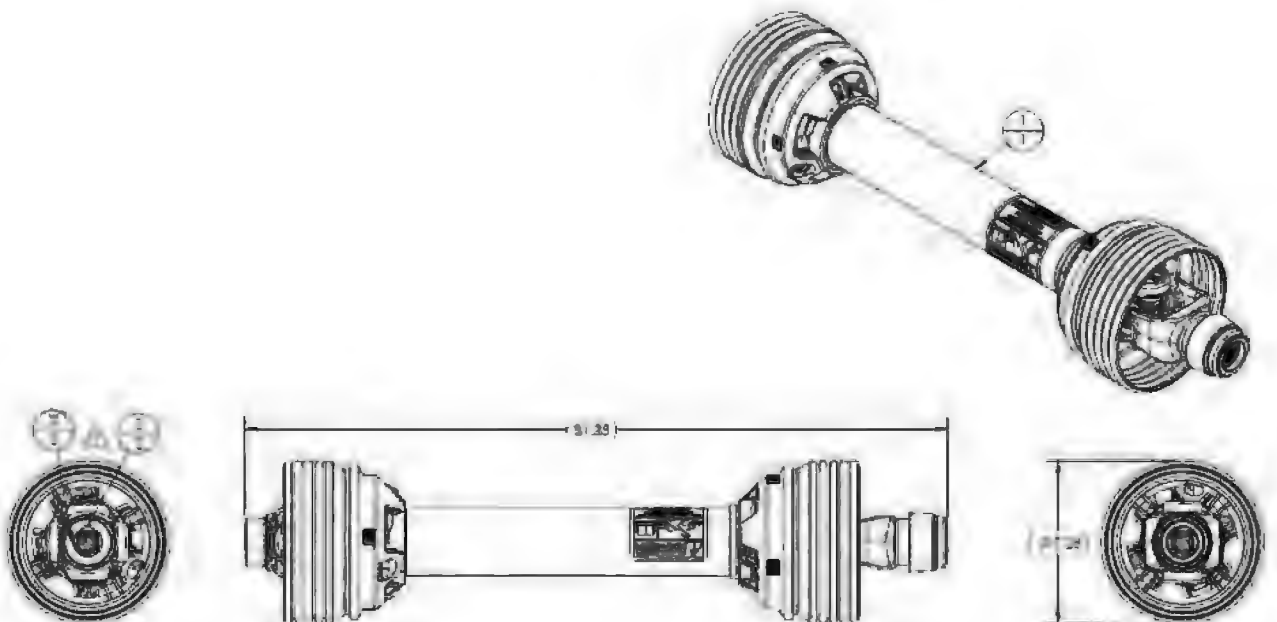

OPTIONS

1-3/4" 1000 RPM Standard Length PTO

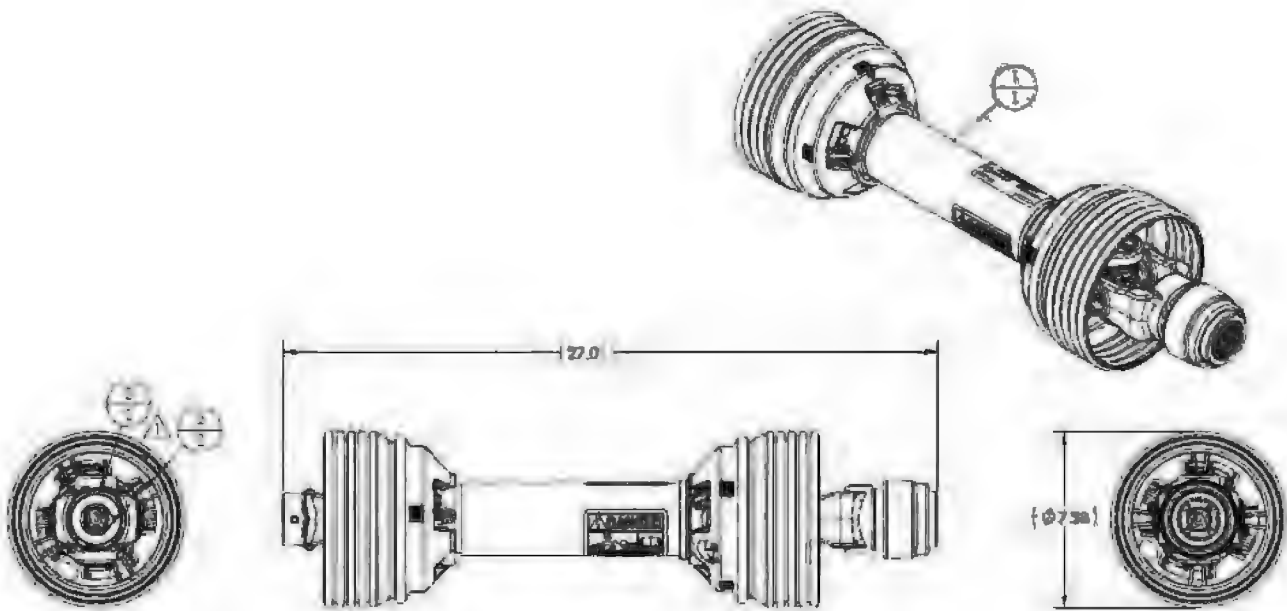

1-3/4" 1000 RPM Long Length PTO

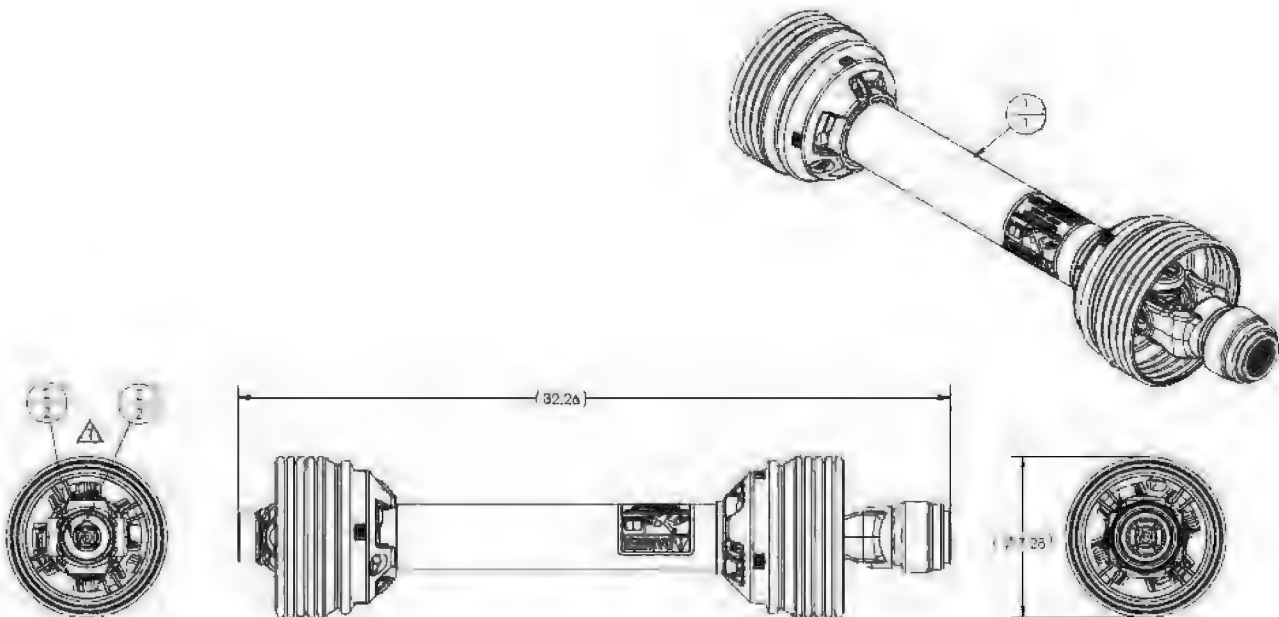

OPTIONS

AUTO GREASE SYSTEM

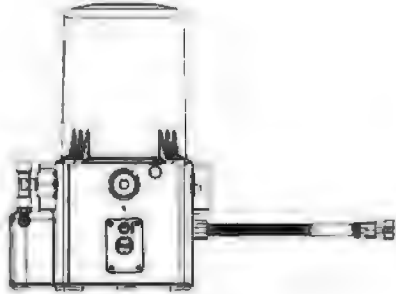

GREASE PUMP



HS102305

NOTE:
BROWN IS FOR GROUND
BLUE IS FOR 5 AMP FUSE

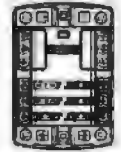

FUSE BLOCK

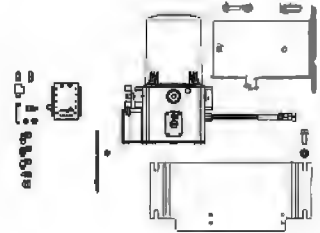
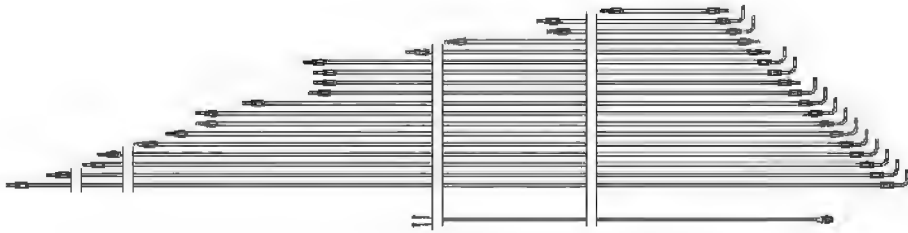

LUBRICATION

GENERAL INFORMATION

IMPORTANT: *Catch and dispose of fluid per local waste disposal regulations whenever service is performed on hydraulic components (valves, cylinders, hoses, etc.) or transmission.*

There are numerous grease fittings on your merger. If these are lubricated properly and often enough, it will prolong the life of the merger. Grease daily during normal use and **before and after storage and after power washing.** Use high-quality grease. **NLGI 2 Grease is recommended.** Make sure grease comes out around the shaft on the sleeve type bearings. On the sealed ball bearings, grease should be added slowly until a slight bead forms at the seals indicating the correct amount of lubricant. Wipe off excess grease to prevent accumulation of grit around the bearings.

For the center cam gearboxes, use SAE30W motor oil. The gearboxes hold 26 ounces of oil.

The tongue reservoir holds 65 gallons of ISO 46 hydraulic oil.



LUBRICATION

One on each wheel hub (80/90 Gear Oil)

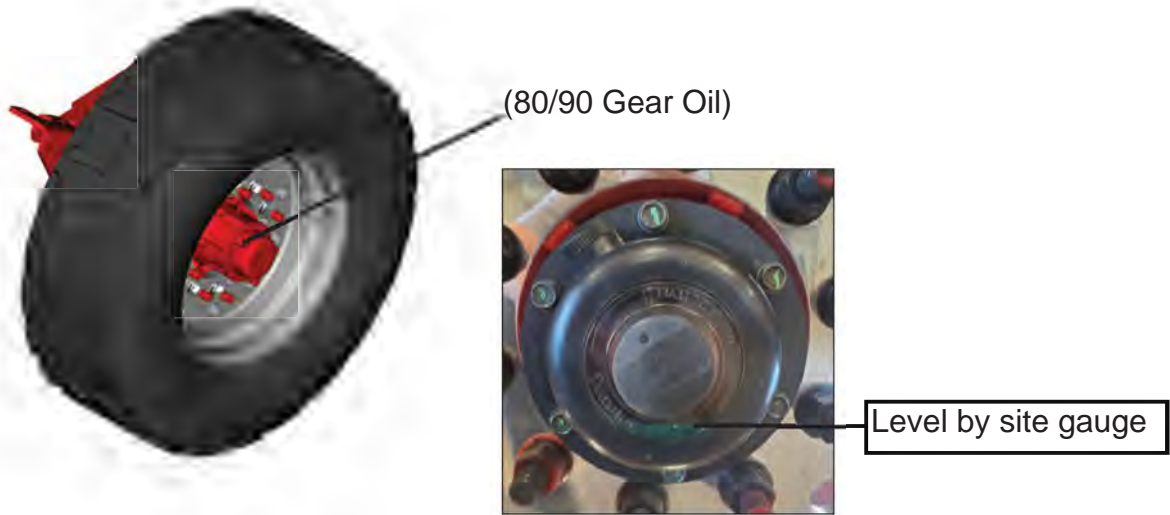

One on each end of each pickup head.

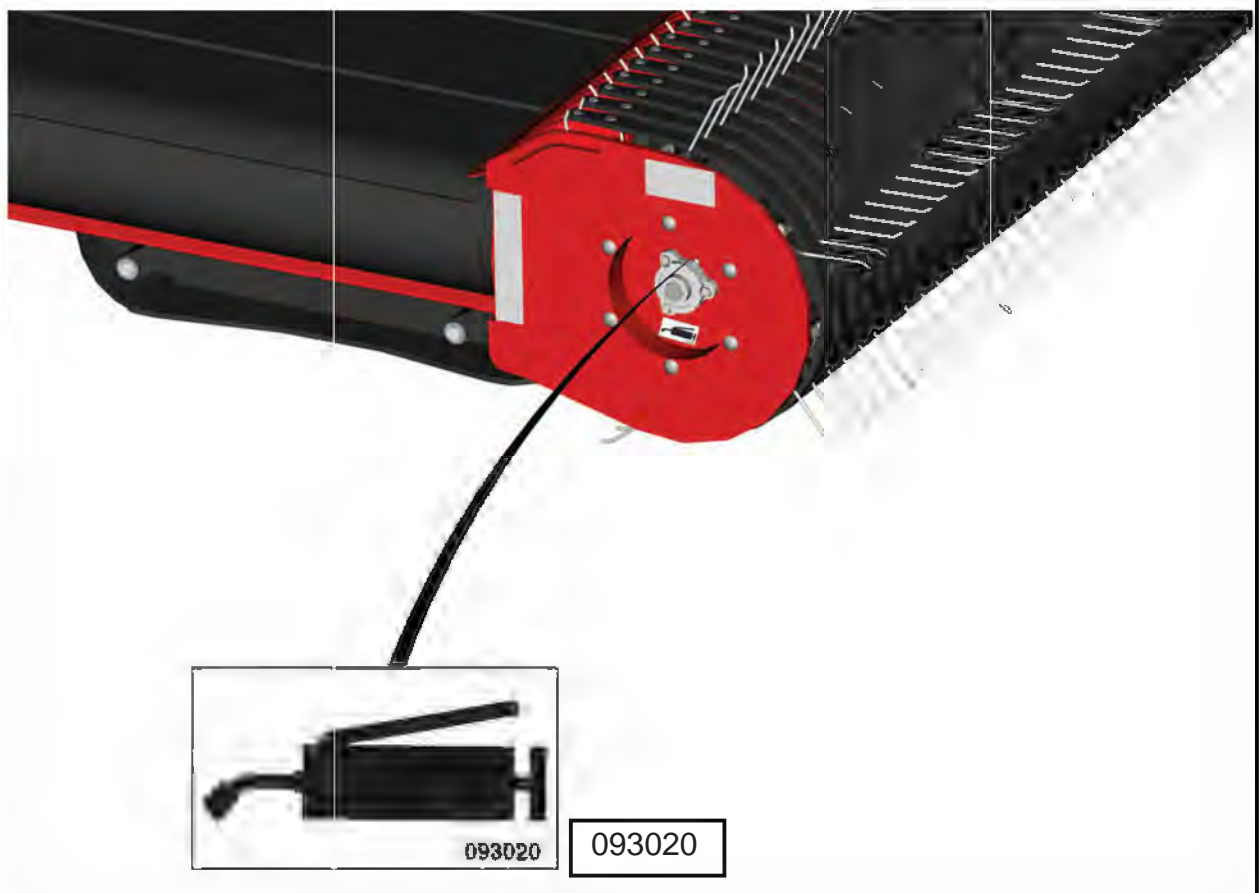

LUBRICATION

One on each head pivot. Grease every 40 hours.

Right Head

Left Head



093020



Grease Annually



093020

LUBRICATION

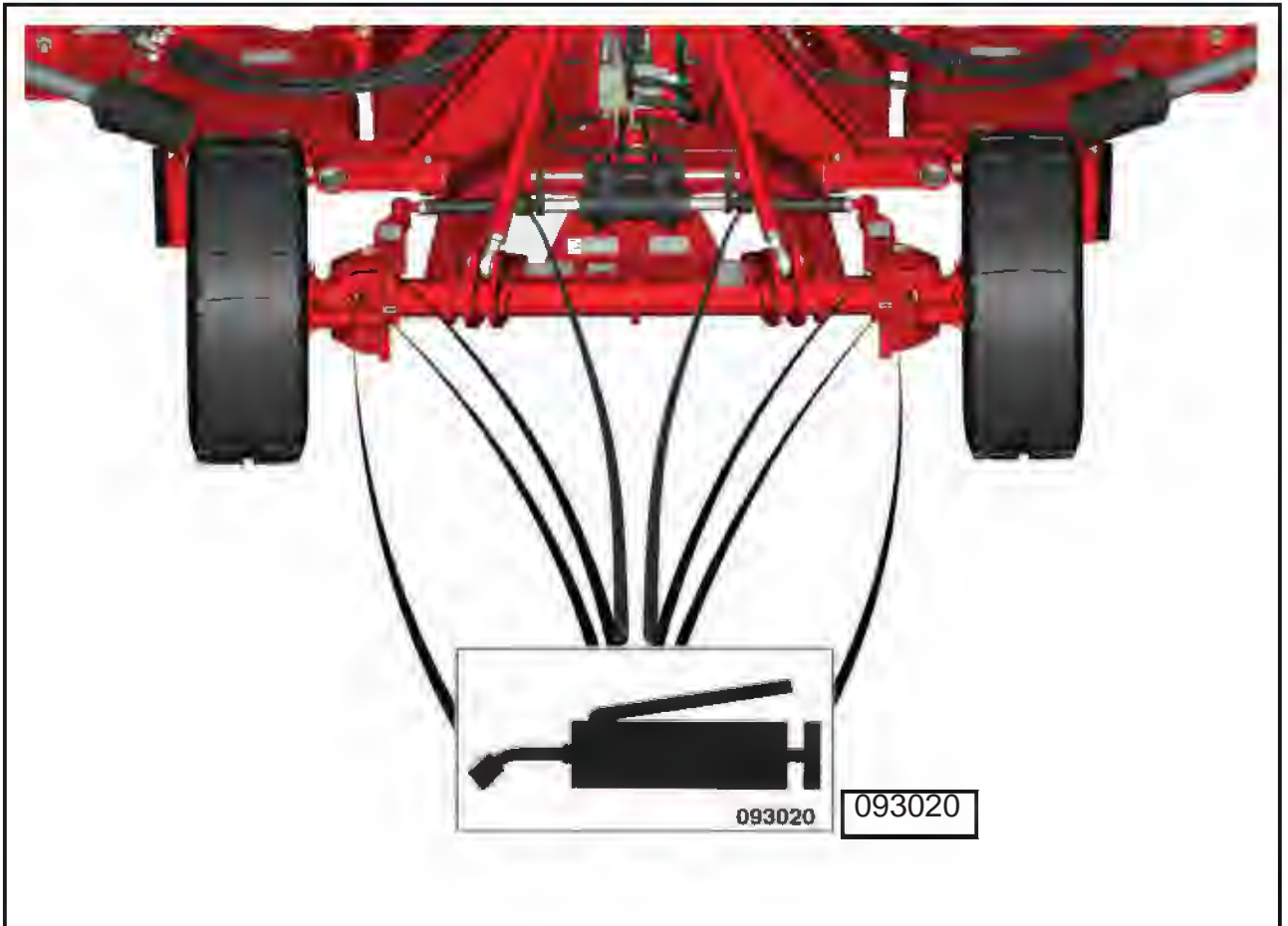
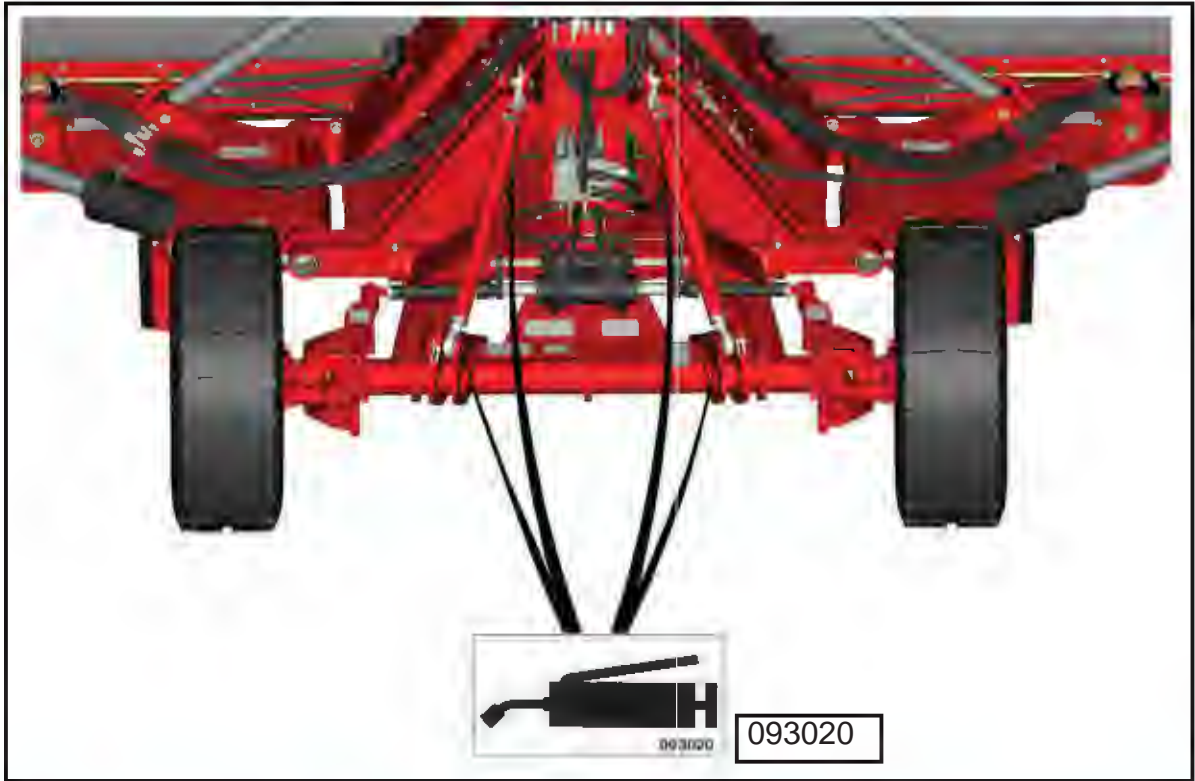

LUBRICATION

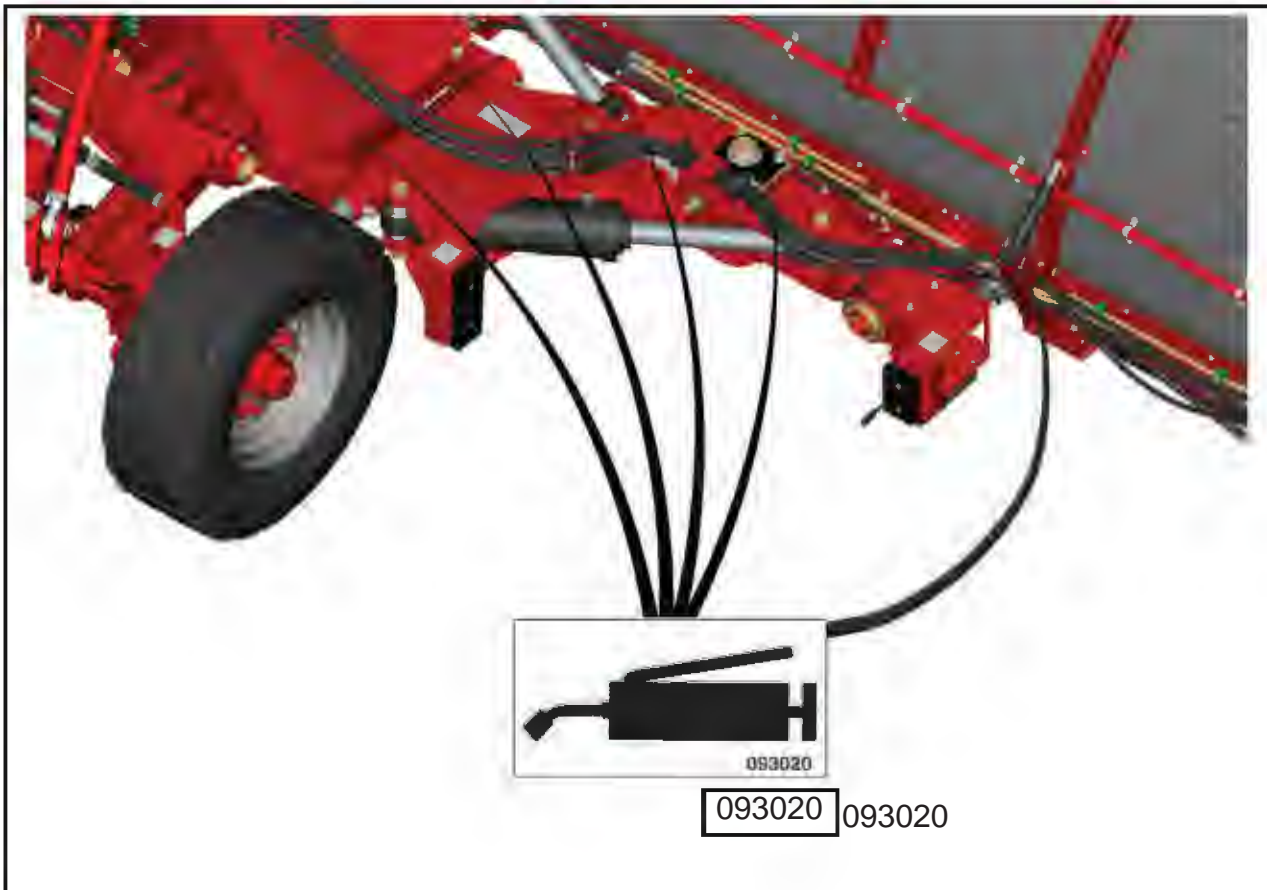

LUBRICATION

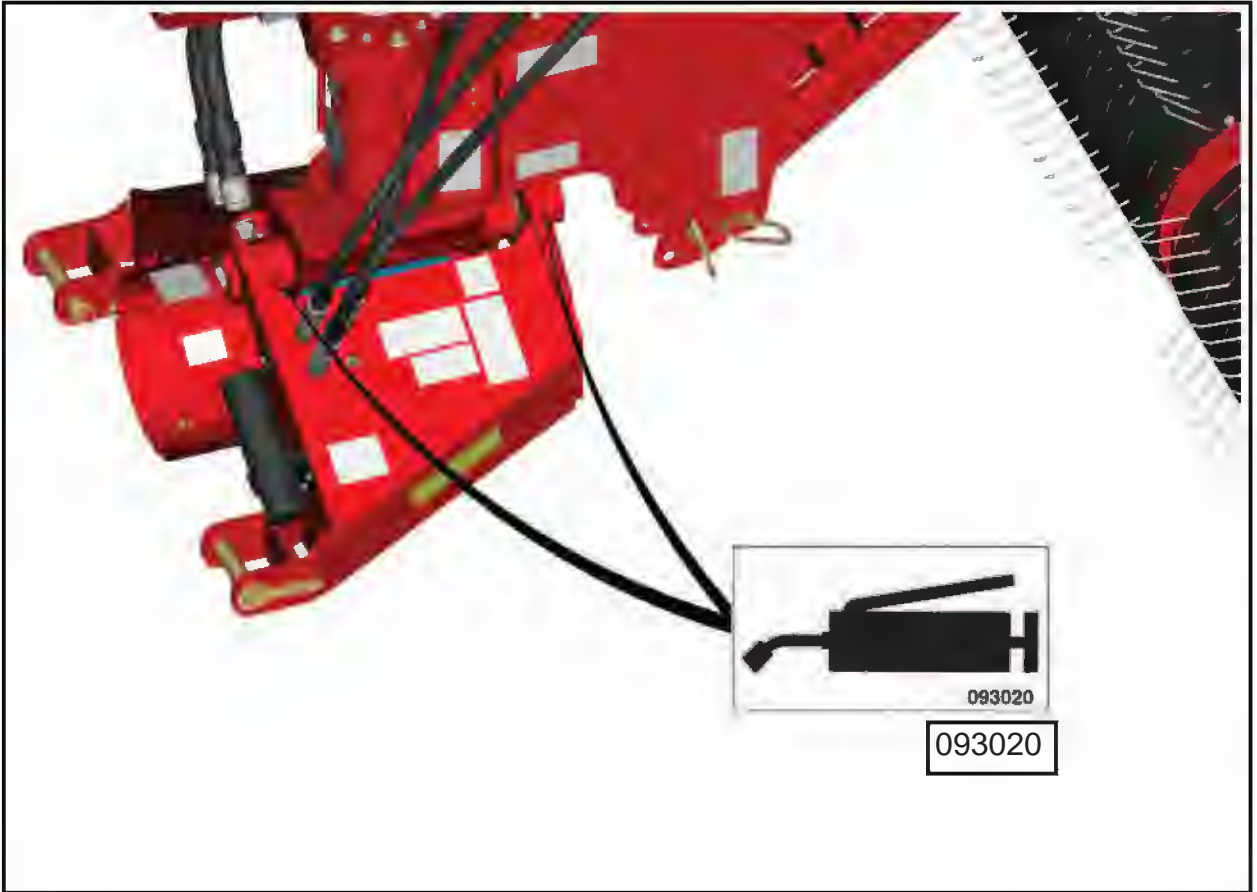

DECAL LOCATION

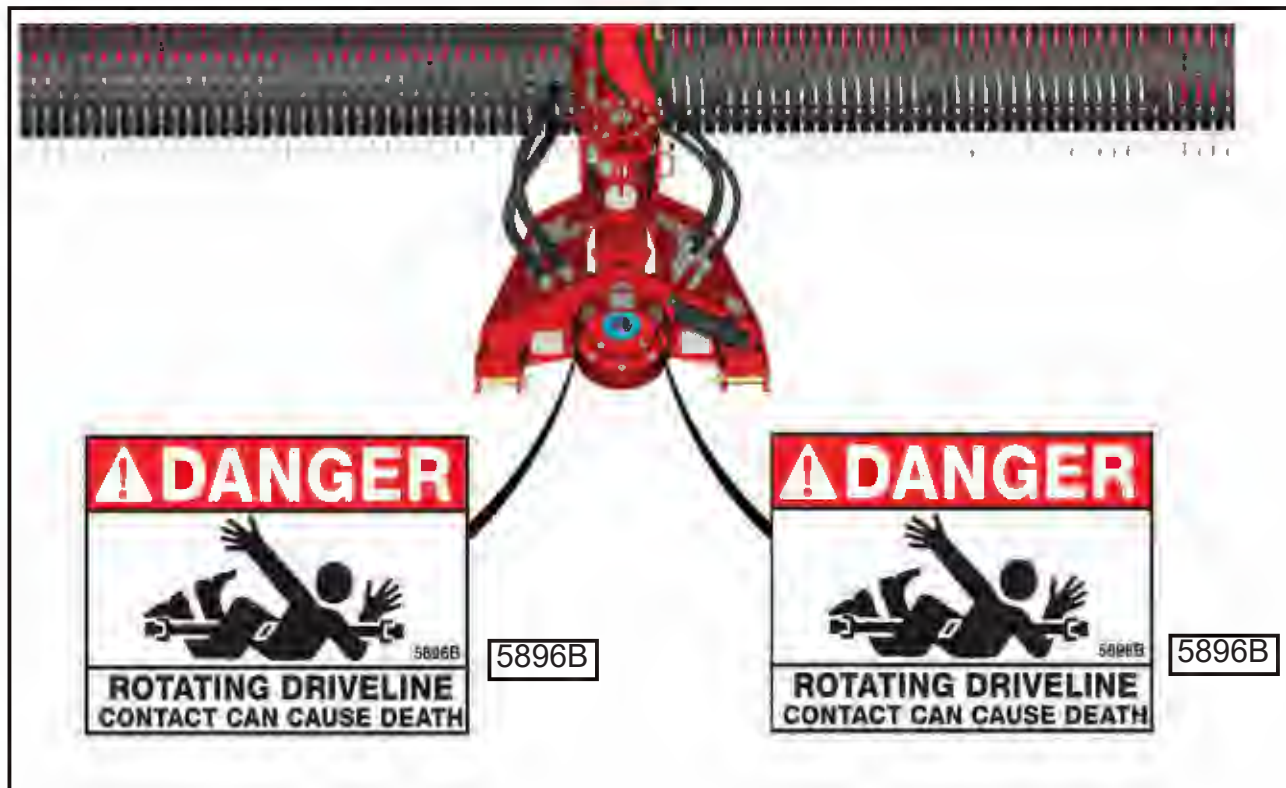

DECAL LOCATION

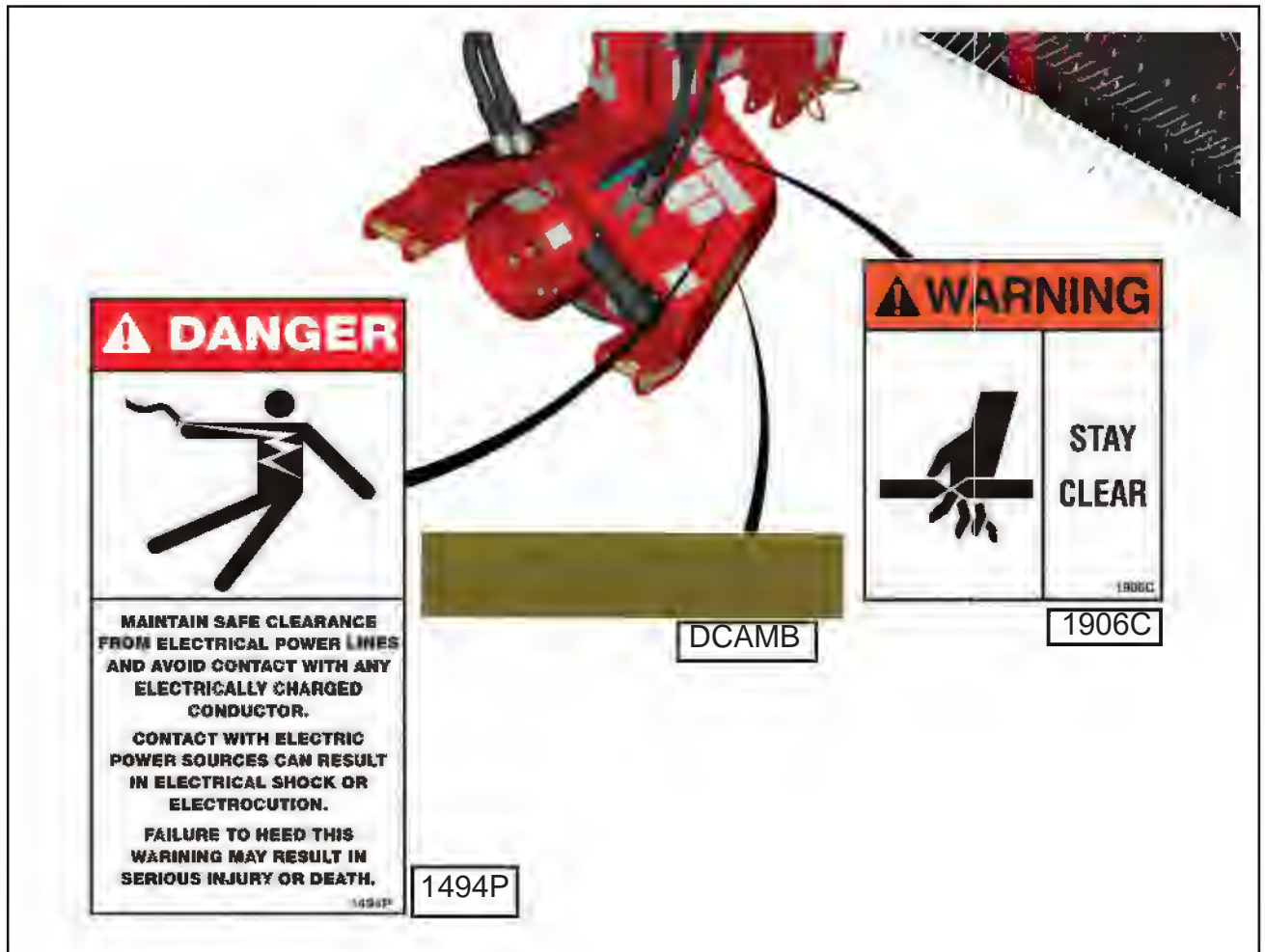

DECAL LOCATION

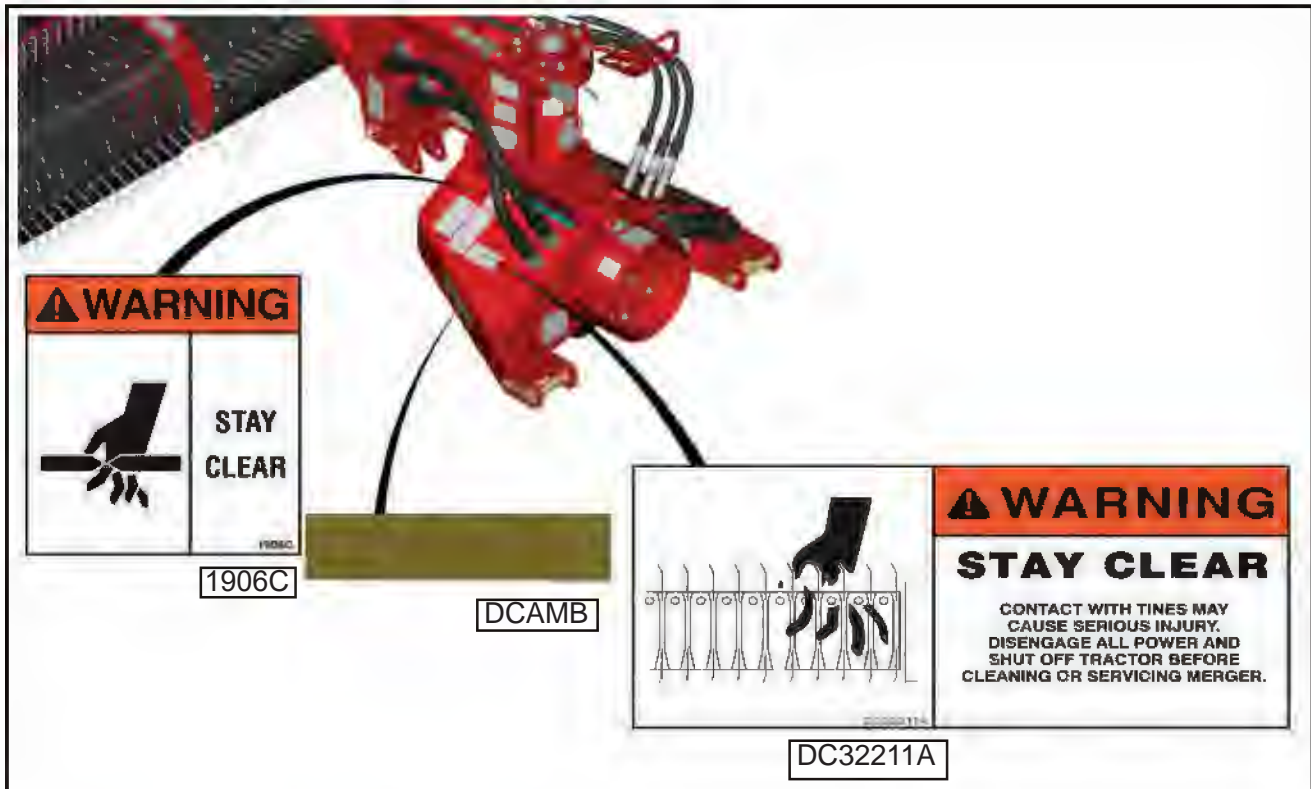

DECAL LOCATION



⚠ WARNING

DO NOT GO NEAR LEAKS

- High pressure oil easily punctures skin causing serious injury, gangrene or death.
- If injured, seek emergency medical help. Immediate surgery is required to remove oil.
- Do not use finger or skin to check for leaks.
- Lower load or relieve hydraulic pressure before loosening fittings.

11599

11599

⚠ DANGER



STAY CLEAR OF MOVING PARTS

FAILURE TO HEED THIS WARNING MAY RESULT IN PERSONAL INJURY OR DEATH

KEEP CLOTHING, YOURSELF AND OTHERS WELL CLEAR.

73101



⚠ DANGER



NEVER ALLOW RIDERS ON THIS MACHINE

82907L

⚠ WARNING

SLAG GENERATED BY HEATING OR CUTTING NEAR PRESSURIZED FLUID LINES CAN PUNCTURE LINES RESULTING IN SEVERE INJURY. NEVER WELD OR CUT ON HYDRAULIC RESERVOIR OR FRAME WORK USED AS A RESERVOIR.

DC32211B

DECAL LOCATION

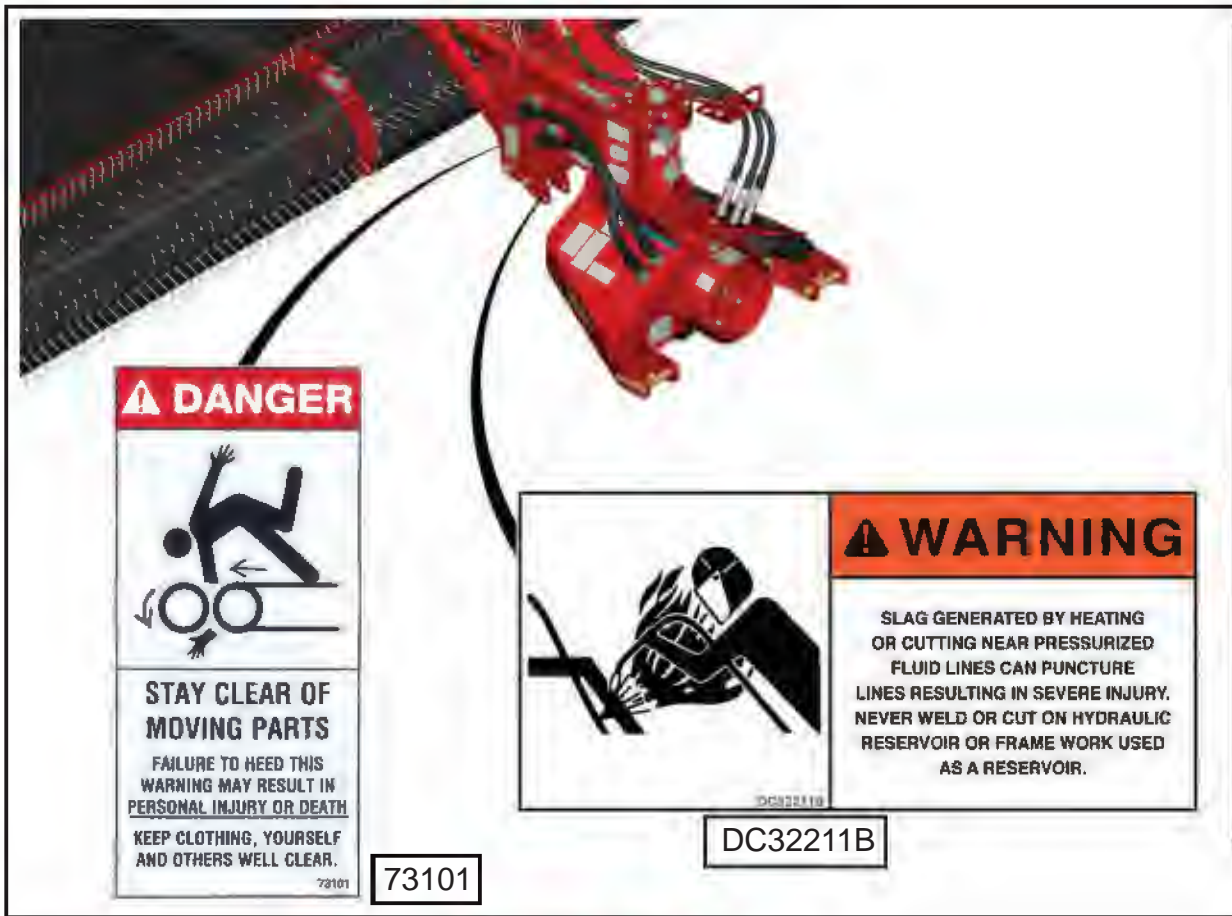

⚠ DANGER



STAY CLEAR OF MOVING PARTS

FAILURE TO HEED THIS WARNING MAY RESULT IN PERSONAL INJURY OR DEATH

KEEP CLOTHING, YOURSELF AND OTHERS WELL CLEAR.

73101



DC32211B

⚠ WARNING

SLAG GENERATED BY HEATING OR CUTTING NEAR PRESSURIZED FLUID LINES CAN PUNCTURE LINES RESULTING IN SEVERE INJURY. NEVER WELD OR CUT ON HYDRAULIC RESERVOIR OR FRAME WORK USED AS A RESERVOIR.

DC32211B



⚠ WARNING

HELP AVOID INJURY

- READ & UNDERSTAND THE OPERATORS MANUAL PROVIDED WITH THIS MACHINE. IF MANUAL IS MISPLACED CONTACT YOUR HES MANUFACTURING DEALER WITH MODEL AND SERIAL NUMBER
- UNDERSTAND ALL SAFETY WARNINGS AND FUNCTION OF CONTROLS.
- KEEP SAFETY DEVICES IN PLACE AND WORKING.
- KEEP YOURSELF AND OTHERS WELL CLEAR OF MOVING PARTS.
- DISCONNECT ALL POWER BEFORE SERVICING OR CLEANING THIS MACHINE.
- DO NOT EXCEED 20 MPH

72203A

⚠ WARNING



STAY CLEAR

1906C

72203A

1906C

DECAL LOCATION

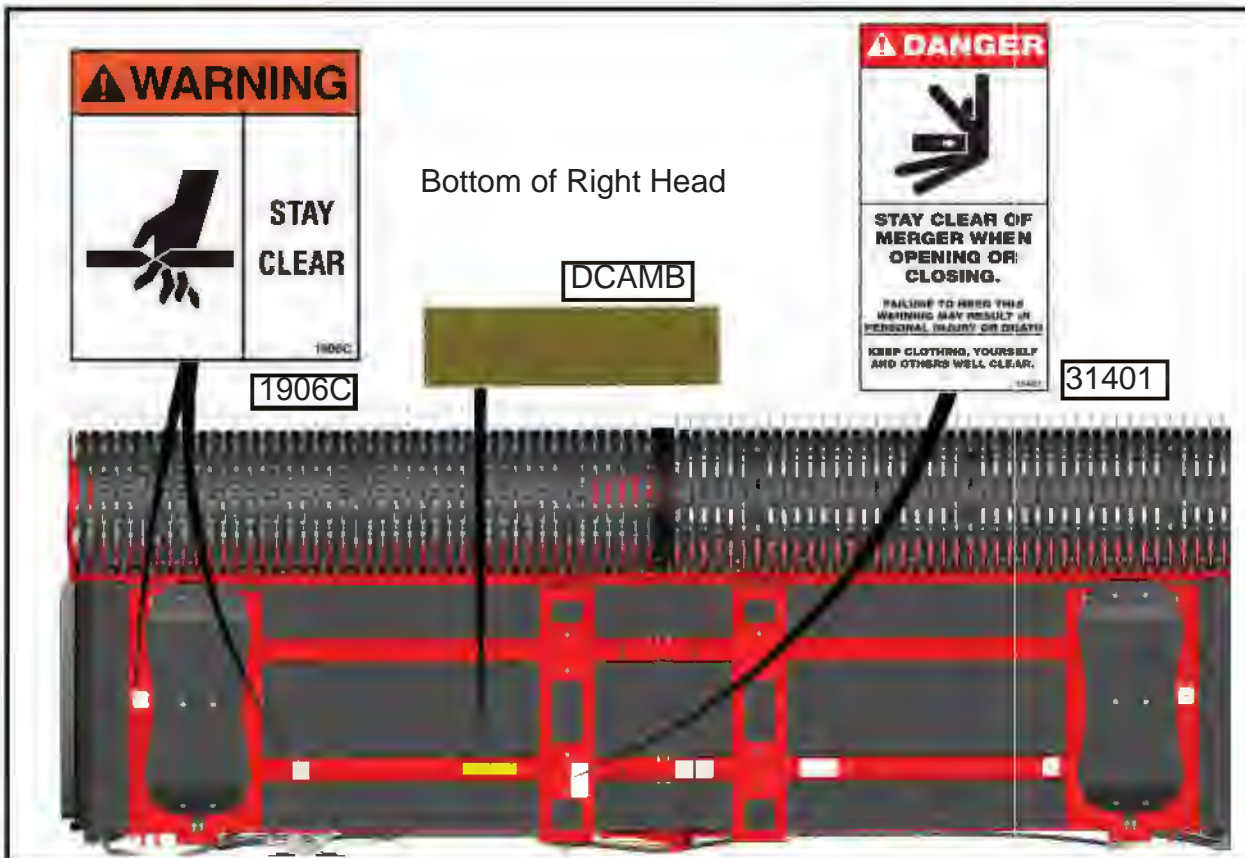

DECAL LOCATION

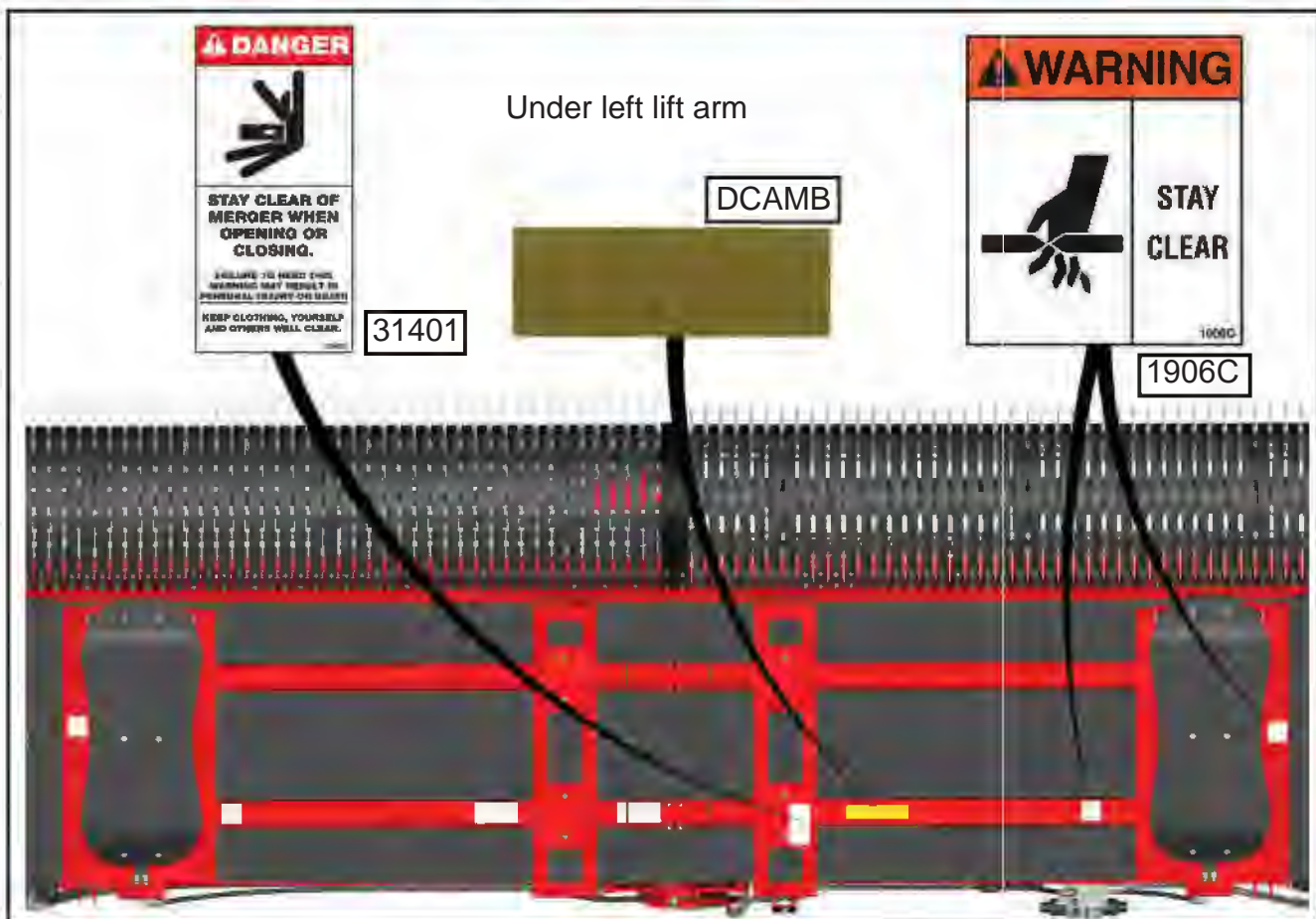
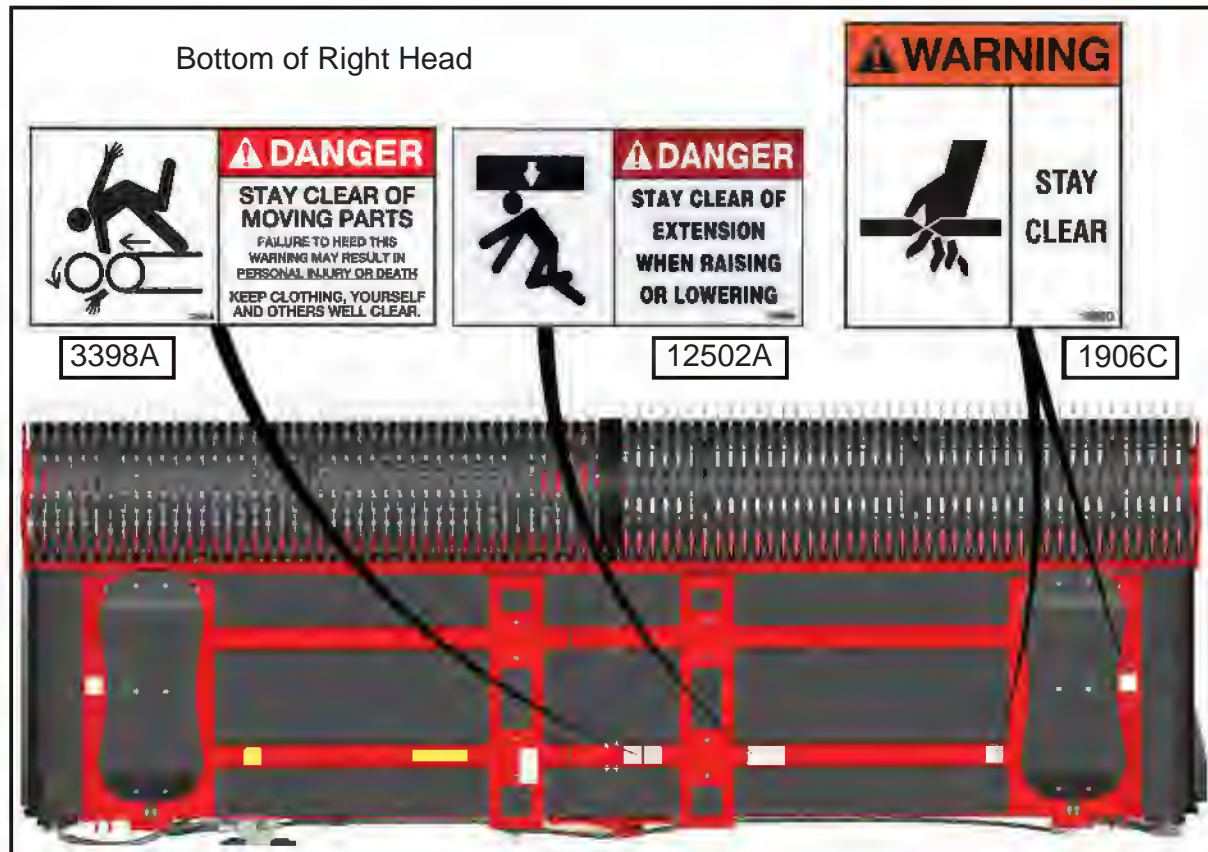

DECAL LOCATION

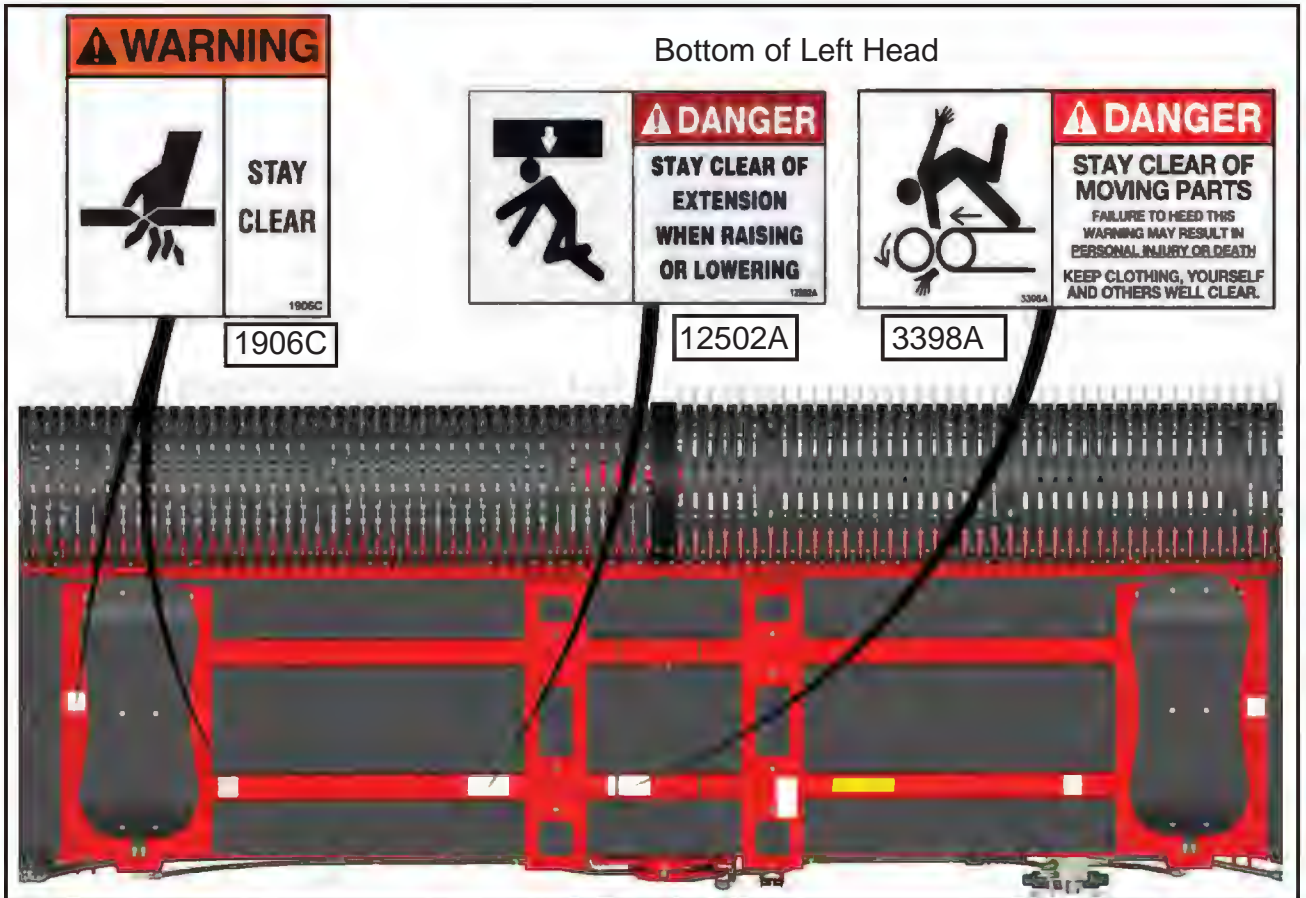

DECAL LOCATION



DECAL LOCATION

Under right lift arm



73101



31401



Under right lift arm



11599

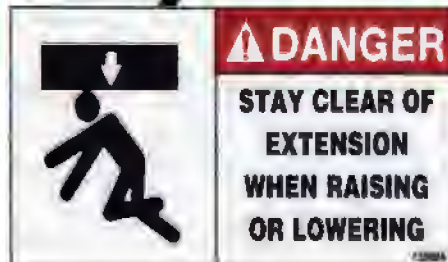

12502A

DECAL LOCATION

Top left lift arm



1906C



Top right lift arm

Top right lift arm



1906C

1906C

DECAL LOCATION

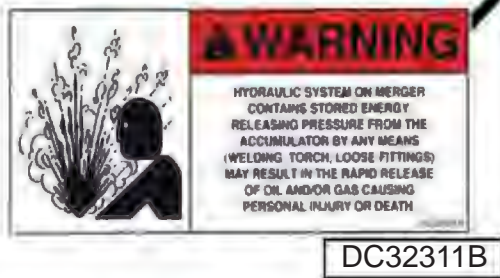

DECAL LOCATION



⚠ WARNING

DO NOT GO NEAR LEAKS

- High pressure oil easily punctures skin causing serious injury, gangrene or death.
- If injured, seek emergency medical help. Immediate surgery is required to remove oil.
- Do not use finger or skin to check for leaks.
- Lower load or relieve hydraulic pressure before loosening fittings.

11599

11599

⚠ DANGER

STAY CLEAR OF MERGER WHEN OPENING OR CLOSING.

FAILURE TO HEED THIS WARNING MAY RESULT IN PERSONAL INJURY OR DEATH

KEEP CLOTHING, YOURSELF AND OTHERS WELL CLEAR.

31401

31401



⚠ WARNING

DO NOT GO NEAR LEAKS

- High pressure oil easily punctures skin causing serious injury, gangrene or death.
- If injured, seek emergency medical help. Immediate surgery is required to remove oil.
- Do not use finger or skin to check for leaks.
- Lower load or relieve hydraulic pressure before loosening fittings.

11599

11599

⚠ DANGER

STAY CLEAR OF MERGER WHEN OPENING OR CLOSING.

FAILURE TO HEED THIS WARNING MAY RESULT IN PERSONAL INJURY OR DEATH

KEEP CLOTHING, YOURSELF AND OTHERS WELL CLEAR.

31401

31401



DECAL LOCATION



DECAL LOCATION

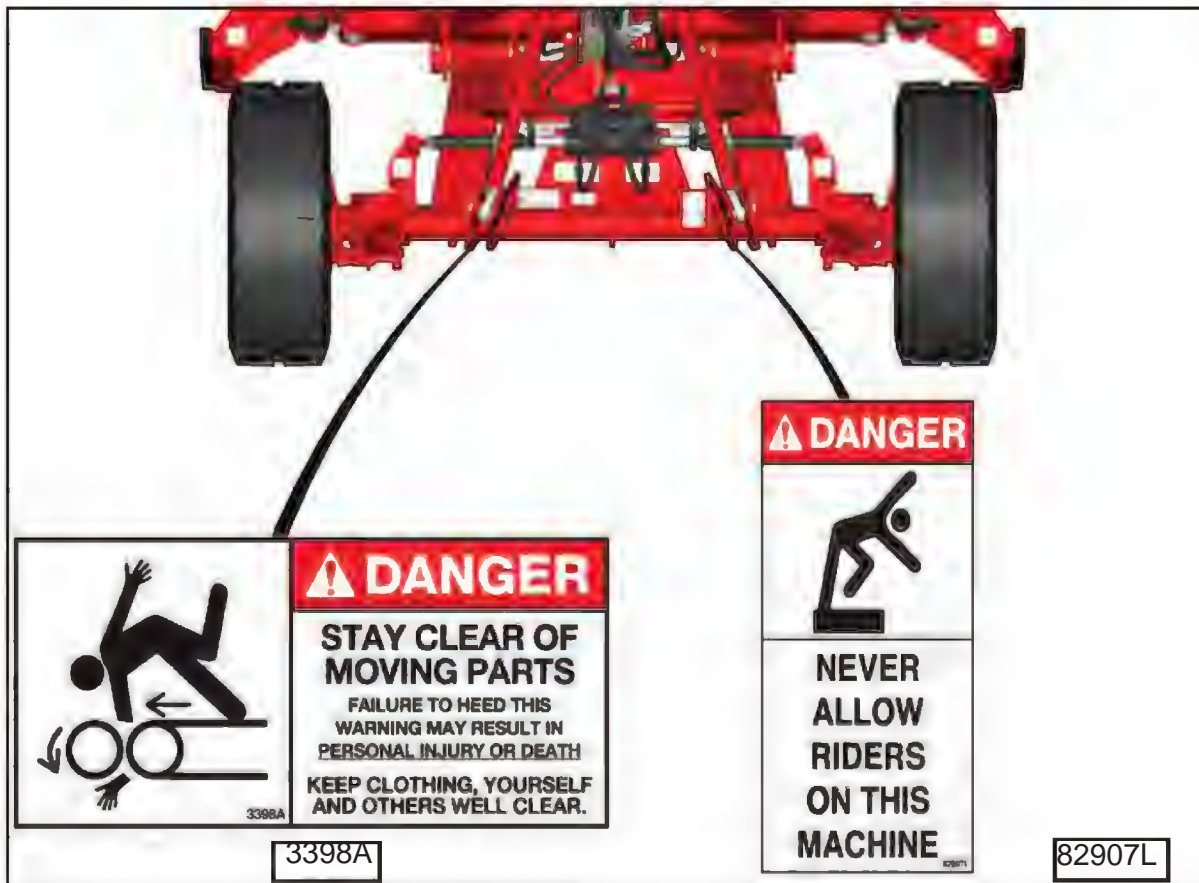

BRANDING LOCATION



BRANDING LOCATION

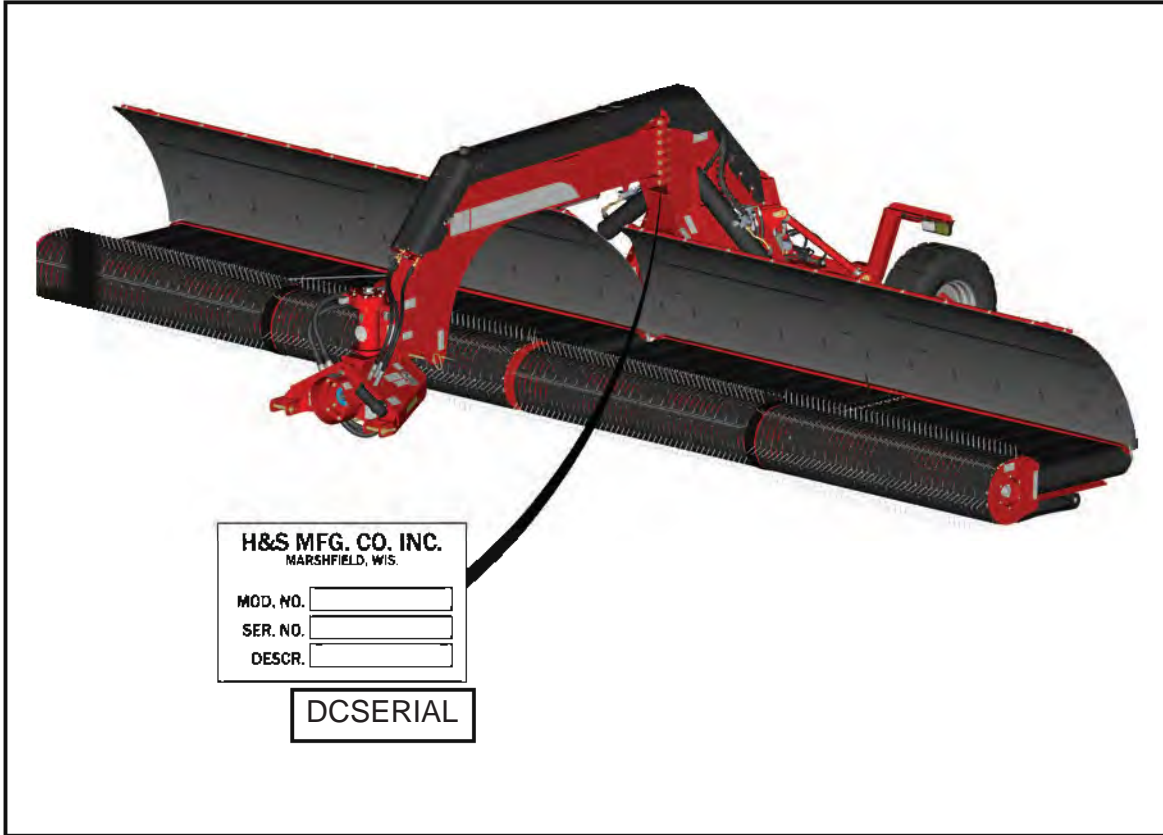

NOISE LEVEL SAFETY

Prolonged exposure to loud noise can cause impairment or loss of hearing.

Wear PPE such as earmuffs or earplugs to protect against objectionable or uncomfortable loud noises.

The following information provides noise levels produced by this machine:

A-weighted emission sound pressure level at the operations station can vary based on the sound proofing contained within the tractor's cab towing the merger..

A-weighted emission sound pressure level at eight positions around machine as indicated in table:

MEASURED SOUND PRESSURE LEVELS dB(A)								
Position								
1	2	3	4	5	6	7	8	Average
2.35	7.06	11.2	17.8	19	16.45	9.95	5.55	11.14375

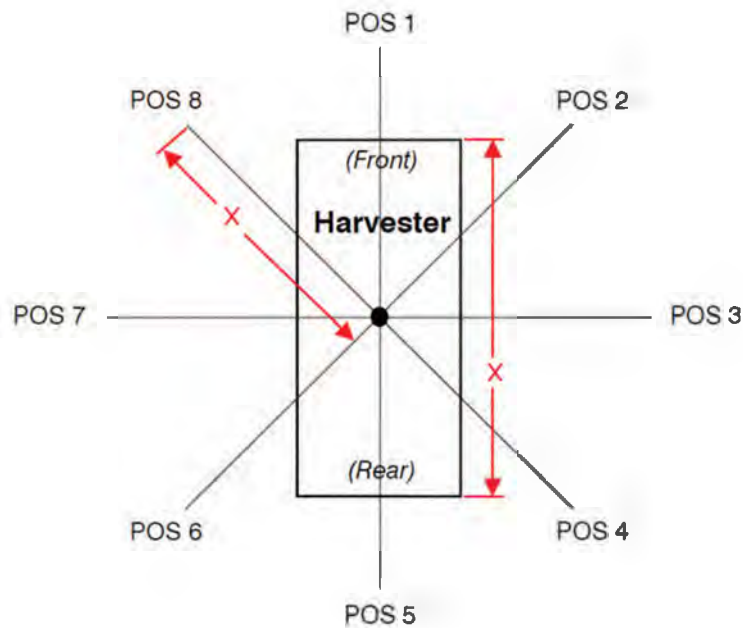

Distance to Positions

Center point of machine to any position is equal to the length of the machine including header.



Manufactured By:

H&S MANUFACTURING CO., INC.

2608 S. HUME AVE. MARSHFIELD, WI 54449

(715) 387-3414 | hsmfgco.com

