

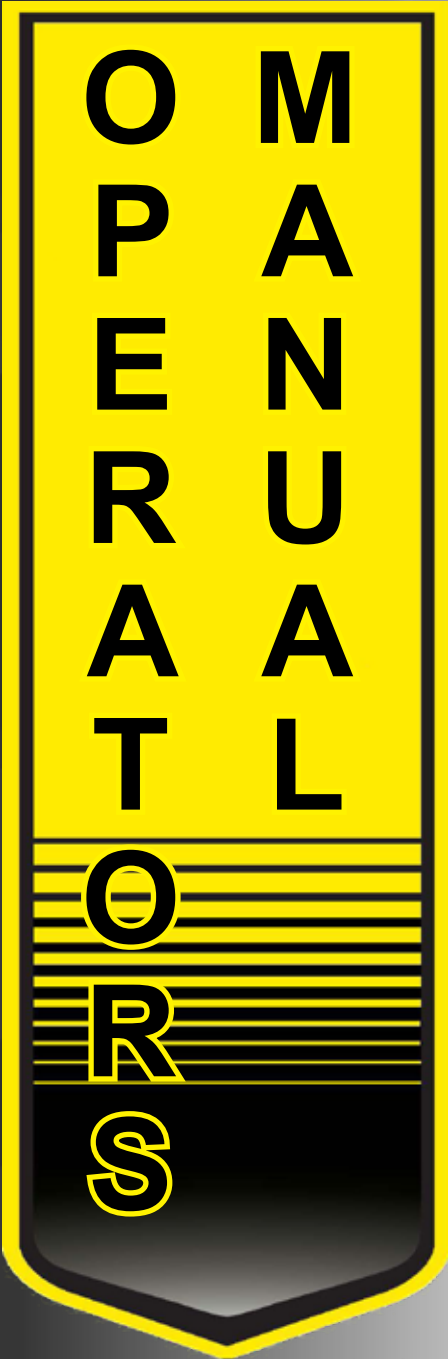

5234
TOP SHOT
SPREADER



WARNING

READ AND UNDERSTAND THIS MANUAL BEFORE OPERATING THIS EQUIPMENT. UNSAFE OPERATION OR MAINTENANCE OF THIS EQUIPMENT CAN RESULT IN SERIOUS INJURY OR DEATH.

Starting Serial #322TS34001

Part#76942

Rev. #04

HSMFG0123

STRONG HERITAGE - STRONG PEOPLE - STRONGER FUTURE

CONTENTS

Warranty	1
Manufacturer's Statement	2
Warranty Registration Form	3
Dealer Pre-Delivery Checklist	5
Dealer Delivery Checklist	7
Safety Information - Be Alert Symbol	9
Explanation of Safety Signs	10
Safety Decals	11-12
Safety Information - Warning - Owner Must Read and Understand	13
Cap Screw Torque Values	14
Hydraulic Torque Specs.	15-16
Set-Up & Assembly	17
Transporting	18
Storage	18
Preparing for Operation	19-20
Operation	21-26
Adjustments	27-28
Service	29-30
Optional Equipment	31
Lubrication Guide	32-35
Decal Location	36-39
Troubleshooting Guide	40
Service Notes	41-42

H&S WARRANTY

H&S Manufacturing Co., Inc. ("H&S") warrants this product to be free from defect in material and workmanship. Except as noted below, this warranty term is twelve (12) months on parts and labor, and twenty-four (24) months on parts only from the date of delivery of the product to the original purchaser by an authorized H&S dealer. Under this warranty, H&S will repair or replace, at its option, any covered part which is found to be defective in material or workmanship during the applicable warranty term. In no case will the covered repair cost of a part or parts exceed the replacement cost of that part. In no case, unless pre-authorized by H&S, will a component be replaced versus repaired unless the cost of labor and parts exceeds 75% of the cost of a new component. Warranty repairs must be performed by H&S or a dealer authorized by H&S to sell and/or service the product involved, and will use only new or remanufactured parts or components furnished by H&S. Any warranty repairs needing to be performed by a third party must be pre-authorized by H&S. Standard freight costs will be covered by H&S for any part used to make a warrantable repair, any form of express freight will not be covered unless pre-authorized by H&S. This warranty includes approved parts and labor to repair the product but does not include, and the purchaser is responsible for, any service call and/or transportation of the product to and from the dealer's place of business, for any costs related to travel, for any premium charged for overtime labor requested by the purchaser, and for any service work not directly related to any defect covered under this warranty.

This warranty includes only those components of the product manufactured by H&S. Warranty for any component not manufactured by H&S including, but not limited to, engines, batteries, tires, rims, hydraulic motors, pumps, etc. are covered by the warranty, if any, provided separately by their respective manufacturers. H&S reserves the right to request the return of any failed component.

This warranty in all its parts is extended solely to the original purchaser of the product, is terminated upon any subsequent transfer or sale from or by the original purchaser, and extends no third party benefits or rights whatsoever.

The warranty term for any product used in any for hire, rental fleet or rental application, is limited to six (6) months from the date of delivery of the product to the original purchaser by an authorized H&S dealer.

This warranty does not include: (1) Any product that has been altered or modified in ways not approved by H&S; (2) Depreciation or damage caused by normal wear, use for which the product was not designed, misuse, improper or insufficient maintenance, improper operation, accident or failure to follow the product Operator's Manual recommendations and product decal recommendations; (3) Normal maintenance parts and service; (4) Repairs made with parts other than those available from H&S or performed by anyone other than H&S or a dealer authorized by H&S to sell and/or service the product involved.

To secure warranty service the purchaser must report the product defect to a dealer authorized by H&S to sell and/or service the product involved within the applicable warranty term together with evidence of the warranty start date and make the product available to that dealer within a reasonable period of time.

For these warranty terms to be in effect the selling authorized H&S dealer and/or the customer must submit the warranty registration to H&S.

THERE ARE NO WARRANTIES WHICH EXTEND BEYOND THE DESCRIPTION ON THE FACE OF THIS WARRANTY. H&S and the companies affiliated with it make no warranties, representations, or promises, express or implied, as to the performance or freedom from defect of its products other than those set forth above and NO IMPLIED WARRANTY OF MERCHANTABILITY, FITNESS OR FITNESS FOR A PARTICULAR PURPOSE IS MADE. IN NO EVENT WILL THE DEALER, H&S OR ANY COMPANY AFFILIATED WITH H&S BE LIABLE FOR INCIDENTAL OR CONSEQUENTIAL DAMAGES. The ONLY REMEDY the purchaser has in connection with the breach of performance of any warranty on H&S products are those set forth above.

The selling dealer has no authority to make any representation or promise on behalf of H&S, or to modify the terms or limitations of this warranty in any way.

12/20/22

MANUFACTURER'S STATEMENT

Congratulations on your selection of an H&S product. Your new H&S product has been manufactured of the finest quality materials and components. The performance you receive from your machine is largely dependent upon how well you read, understand this manual, and apply this knowledge. There is a right and a wrong way to do everything. Please do not assume that you know how to operate and maintain your machine before reading this manual carefully. Keep this manual available for ready reference. We are very appreciative of your patronage.

H&S reserves the right to make changes or add improvements to its products at any time without incurring any obligation to make such changes to products previously manufactured. Specifications, statements and descriptions of products contained in this publication are subject to change without prior notification.

WARRANTY REGISTRATION

- Date of Purchase: _____
- Purchaser Name: _____
- Street Address: _____
- City: _____
- State: _____ Zip: _____
- Phone Number: _____
- E-mail Address: _____
- Product: _____
- Model Number: _____
- Serial Number: _____
- You have received the Operator's Manual for this product. Yes _____ No _____
- Interested in receiving the H&S E-mail Newsletter? Yes _____ No _____

-
- Dealer Name: _____
 - Street Address: _____
 - City: _____
 - State: _____ Zip: _____
 - Signature: _____

- All fields must be filled out to ensure prompt notification of product and/or warranty updates.

**Please mail the completed WARRANTY REGISTRATION FORM to:
H&S Manufacturing Co., Inc.
2608 S. Hume Ave.
Marshfield, WI 54449**

Intentionally Left Blank

DEALER PRE-DELIVERY CHECKLIST

AFTER COMPLETION, DEALER SHOULD REMOVE AND RETAIN FOR RECORDS

After the **TOP SHOT** has been completely set up, check to be certain it is in correct operating order before delivering to the customer. The following is a list of points to inspect. Check off each item as you have made the proper adjustments and found the item operating satisfactorily.

- TOP SHOT** was not damaged in shipment. Check for dents and loose or missing parts. Report damage immediately to H&S Manufacturing Co., Inc.
- All bolts and fasteners are tight.
- TOP SHOT** has been correctly assembled according to instructions in this manual. Wheel nuts and all other fasteners are tightly secured.
- All grease fittings have been lubricated. Gearboxes are filled to proper levels if applicable. See Lubrication Chapter of this manual for details.
- Hoses and fittings are properly attached and there are no visible leaks.
- Guards and shields are secure.
- Wheels are properly mounted.
- Tires are inflated to correct pressure.
- Chain tension is properly adjusted. See Adjustment Chapter of this manual.
- Decals are in place and legible.

Connect the *TOP SHOT* onto a proper horsepower 540 RPM or 1000 RPM (if applicable) tractor and attach the PTO. Connect the lights. Run the *TOP SHOT* and make sure all components operate properly.

- PTO guard turns freely.
- Discharge door operates smoothly.
- Main Auger operates up and down smoothly.
- Hydraulic system does not leak under pressure.
- Lights and wiring functioning properly.
- Electronic Scale (if provided) operates properly.
- Implement and all components are functioning properly.

Inspection Date _____ Model Number _____

Serial Number _____

Dealer's Name _____

Signature of Pre-Delivery Inspector _____

(Remove Dealer File Copy At Perforation)

Intentionally Left Blank

DEALER DELIVERY CHECKLIST

AFTER COMPLETION, DEALER SHOULD REMOVE AND RETAIN FOR RECORDS

This checklist that follows is an important reminder of valuable information that should be passed on to the customer at the time this machine is delivered.

Check off each item as you explain it to the customer.

This delivery checklist, when properly filled out and signed, assures the customer that the Pre-Delivery Service was satisfactorily performed.

- Explain to the customer that the Pre-Delivery Inspection was made.
- Explain to the customer all the safety precautions they must exercise when operating this unit.
- Explain to customer that regular lubrication is required for proper operation and long life of machine. Show customer the Lubrication Chapter of the Operator's Manual.
- Give the customer the Operator's Manual and make sure they read and understand all operating and service instructions.
- Record model and serial number on this page and page 38 of this Operator's Manual.
- Have customer sign a completed "Warranty Registration" and mail it promptly.

(Remove Dealer File Copy At Perforation)

Date Delivered _____

Dealer's Name _____

By _____

Signature of Original Buyer _____

Note: Warranty is not valid until warranty card is completed and returned to H&S Mfg. Co., Inc.

Intentionally Left Blank

SAFETY INFORMATION



**BE
ALERT!**

**YOUR SAFETY
IS INVOLVED.**

THIS SYMBOL IS USED THROUGHOUT THIS BOOK WHENEVER YOUR PERSONAL SAFETY IS INVOLVED. TAKE TIME TO BE CAREFUL. REMEMBER: THE CAREFUL OPERATOR IS THE BEST OPERATOR. MOST ACCIDENTS ARE CAUSED BY HUMAN ERROR. CERTAIN PRECAUTIONS MUST BE OBSERVED TO PREVENT THE POSSIBILITY OF INJURY OR DAMAGE.

H&S MANUFACTURING CO., INC.

SAFETY INFORMATION

Keep signs in good condition. Immediately replace any missing or damaged signs.

RECOGNIZE SAFETY INFORMATION

This is the safety alert symbol. When you see this symbol on your machine or in this manual, be alert to the potential for personal injury.

Follow recommended precautions and safe operating practices.



UNDERSTAND SIGNAL WORDS

A signal word - DANGER, WARNING, or CAUTION - is used with the safety alert symbol. DANGER identifies the most serious hazards.

Safety signs with signal word DANGER or WARNING are typically near specific hazards.

General precautions are listed on CAUTION safety signs.



WARNING



CAUTION



FOLLOW SAFETY INSTRUCTIONS

Carefully read all safety messages in this manual, and all safety signs on your machine. Follow all recommended precautions and safe operating procedures.

OBSERVE MAXIMUM TRANSPORT SPEED

The maximum transport speed for this implement is 32 km/h (20 mph).

Some tractors are capable of operating at speeds that exceed the maximum transport speed of this implement. Regardless of the maximum speed capability of the tractor being used to tow this implement, do not exceed the implement's maximum transport speed.

Exceeding the implement's maximum transport speed can result in:

- * Loss of control of the tractor/implement combination
- * Reduced or no ability to stop during braking
- * Implement tire failure
- * Damage to the implement structure or its components

Use additional caution and reduce speed when towing under adverse surface conditions, when turning, and when on inclines.

Do not attempt transport if the fully loaded implement weighs more than 1.5 times the weight of the tractor.

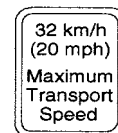

SAFETY INFORMATION



⚠ DANGER

STAY CLEAR OF EXPELLER WHEN ROTATING OR IF TRACTOR IS RUNNING. FAILURE TO HEED THIS WARNING WILL RESULT IN SERIOUS INJURY OR DEATH. KEEP CLOTHING, YOURSELF AND OTHERS WELL CLEAR.

111209B



⚠ DANGER

KEEP OUT

DISENGAGE ALL POWER AND SHUT OFF TRACTOR ENGINE BEFORE ATTEMPTING TO ENTER OR CLEAN SPREADER. FAILURE TO HEED THIS WARNING WILL RESULT IN SERIOUS INJURY OR DEATH.

111209C



⚠ WARNING

DO NOT GO NEAR LEAKS

- High pressure oil easily punctures skin causing serious injury, gangrene or death.
- If injured, seek emergency medical help. Immediate surgery is required to remove oil.
- Do not use finger or skin to check for leaks.
- Lower load or relieve hydraulic pressure before loosening fittings.

11599



⚠ WARNING

DO NOT OPERATE THIS EQUIPMENT IF THIS DECAL IS EXPOSED. REPLACE SAFETY SHIELDS.

1494A



⚠ WARNING

DO NOT REMOVE SHIELDS MOVING PARTS INSIDE

1494B

⚠ DANGER



STAY CLEAR OF BEATER IF TRACTOR OR PTO IS RUNNING.

MANURE AND FOREIGN OBJECTS CAN BE THROWN CONSIDERABLE DISTANCES.

FAILURE TO HEED THIS WARNING MAY RESULT IN PERSONAL INJURY OR DEATH.

KEEP CLOTHING, YOURSELF, AND OTHERS WELL CLEAR.

58703

⚠ WARNING



CRUSHING HAZARD

TO PREVENT SERIOUS INJURY OR DEATH:

KEEP HANDS AND BODY OUT OF HITCH AREA WHEN TOWING VEHICLE.

KEEP BODY CLEAR OF CRUSH POINT BETWEEN TOWING VEHICLE AND LOAD.

KEEP FEET AND LEGS CLEAR FROM UNDER TONGUE AREA IN CASE OF POSSIBLE JACK FAILURE.

82602

⚠ WARNING

HELP AVOID INJURY

- READ & UNDERSTAND THE OPERATORS MANUAL PROVIDED WITH THIS MACHINE. IF MISPLACED CALL H & S MANUFACTURING AT 715-387-3414 WITH MODEL AND SERIAL NUMBER.
- UNDERSTAND ALL SAFETY WARNINGS AND FUNCTION OF CONTROLS.
- KEEP SAFETY DEVICES IN PLACE AND WORKING.
- KEEP YOURSELF AND OTHERS WELL CLEAR OF MOVING PARTS.
- DISCONNECT ALL POWER BEFORE SERVICING OR CLEANING THIS MACHINE.
- DO NOT EXCEED 20 MPH

72203A

SAFETY INFORMATION

! DANGER



**ROTATING DRIVELINE CONTACT CAN CAUSE DEATH
KEEP AWAY!**

DO NOT OPERATE WITHOUT-

- ALL DRIVELINE, TRACTOR AND EQUIPMENT SHIELDS IN PLACE.
- DRIVELINES SECURELY ATTACHED AT BOTH ENDS.
- DRIVELINE SHIELDS THAT TURN FREELY ON DRIVELINE.

1494L

! CAUTION



PINCH POINT

51010

! DANGER



NO STEP-STAY CLEAR

9194A

! CAUTION



**PINCH POINT,
TO AVOID HAND INJURY
USE CAUTION WHEN
CLOSING SHIELD**

111209A

! DANGER



ROTATING DRIVELINE CONTACT CAN CAUSE DEATH

5896B

! DANGER



NEVER ALLOW RIDERS ON THIS MACHINE

9194B

! WARNING



DO NOT CLEAN OR WORK ON THIS MACHINE WITHOUT FIRST DISENGAGING POWER AND SHUTTING OFF TRACTOR ENGINE.

1494J

! WARNING

DO NOT REMOVE SHIELDS ROTATING PARTS INSIDE

11210B

ATTENTION

TORQUE SPECIFICATION FOR HUBS WITH 3/4-16 FLANGE NUTS IS 375-425 FT.-LBS.

THIS TORQUE IS FOR UNLUBRICATED THREADS. THIS TORQUE IS NEEDED FOR THE HUBS TO CARRY THE RATED CAPACITY. IT IS VERY IMPORTANT TO FOLLOW THIS SPECIFICATION WHEN MOUNTING TIRE AND WHEEL ASSEMBLIES ON HUBS

022310

TRACTORS:

This Operator's Manual uses the term "Tractor" when identifying the power source.



TO PREVENT SERIOUS INJURY OR DEATH

BEFORE YOU ATTEMPT TO OPERATE THIS EQUIPMENT, READ AND STUDY THE FOLLOWING INFORMATION. IN ADDITION, MAKE SURE THAT EVERY INDIVIDUAL WHO OPERATES OR WORKS WITH THIS EQUIPMENT, WHETHER FAMILY MEMBER OR EMPLOYEE, IS FAMILIAR WITH THESE SAFETY PRECAUTIONS.

KNOW HOW TO STOP **TOP SHOT** BEFORE STARTING IT.

If the **TOP SHOT** becomes clogged or for servicing, stop the tractor engine, remove ignition key and allow all mechanisms to stop. Before cleaning or working on the **TOP SHOT**, detach the PTO shaft, and completely disengage the tractor hydraulics.

DO NOT attempt to perform maintenance or repair with tractor running, and PTO, and hydraulic hoses connected to the tractor.

DO NOT step up on the **TOP SHOT** at any time while in operation.

NEVER manually feed material into the expeller.

DO NOT allow minors to operate or be near the **TOP SHOT**.

DO NOT ALLOW PERSONNEL OTHER THAN THE QUALIFIED OPERATOR NEAR THE TOP SHOT.

STAY CLEAR of discharge expeller when in operation.

Keep hands, feet, and clothing away from all moving parts when the **TOP SHOT** is in operation.

Loose or floppy clothing should not be worn by the operator.

Be sure the **TOP SHOT** is clear of people, tools, and other objects before engaging PTO.

DO NOT step over PTO shaft: Stay clear of PTO at all times.

NEVER start the **TOP SHOT** until all guards and safety shields are secured in place.

NEVER operate the **TOP SHOT** with a PTO speed greater than the recommended PTO RPM.

STAY CLEAR of hydraulic lines, they may be under extreme pressure or heat.

H&S Mfg. Co. always takes the operator and their safety into consideration and guards exposed moving parts for their protection. However, some areas cannot be guarded or shielded in order to assure proper operation. In addition, the operator's manual and decals on the **TOP SHOT** itself warn you of further danger and should be read and observed closely.

Study The Above Safety Rules
ATTENTION - BE ALERT - YOUR SAFETY IS INVOLVED

CAP SCREW TORQUE VALUES

The specifications below are the torque values for fasteners as it adheres to the SAE torque value standards. All fasteners should be torqued to the proper values found in the figures below unless otherwise specified by the engineering drawing.

- Lubed torque would be any fastener that has grease, liquid Loctite, oil, etc. on the threads.
- Dry torque would be any fastener which has threads that are clean and dry and do not have any liquid Loctite or grease on them.

Hex Head Fasteners

The figure shown below shows how to determine what SAE grade a fastener is.

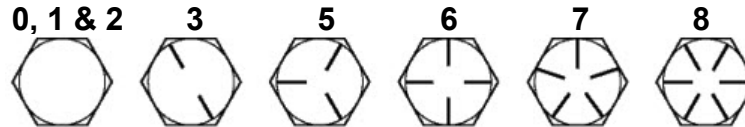

SUGGESTED ASSEMBLY TORQUE VALUES							WORKING TORQUE			
SAE GR. 2-6"		SAE GR. 5		SAE GR. 8			18-8 SS	316 SS	Brass	Silicon Bronze
Dia. & Thrds. per inch	Dry Ft. Lbs.	Lube Ft. Lbs.	Dry Ft. Lbs.	Lube Ft. Lbs.	Dry Ft. Lbs.	Lube Ft. Lbs.	Inch Lbs.	Inch Lbs.	Inch Lbs.	Inch Lbs.
1/4-20	5.5	4.2	8	6.3	12	9	75.2	78.8	61.5	68.6
1/4-28	6.3	4.7	10	7.2	14	10	94.0	99.0	77.0	87.0
5/16-20	11	8	17	13	24	18	132	138	107	123
5/16-28	12	9	19	14	27	20	142	147	116	131
3/8-16	20	15	30	23	45	35	236	247	192	219
3/8-24	23	17	35	25	50	35	259	271	212	240
7/16-14	32	24	50	35	70	50	376	393	317	349
7/16-20	36	27	55	40	80	60	400	418	327	371
1/2-13	50	35	75	55	110	80	517	542	422	480
1/2-20	55	40	85	65	120	90	541	565	443	502
9/16-12	70	55	110	80	150	110	682	713	558	632
9/16-18	80	60	120	90	170	130	752	787	615	697
5/8-11	100	75	150	110	210	160	1110	1160	907	1030
5/8-18	110	85	170	130	240	180	1244	1301	1016	1154
3/4-10	175	130	260	200	380	280	1530	1582	1249	1416
3/4-16	200	140	300	220	420	310	1490	1558	1220	1382
7/8-9	170	125	430	320	600	450	2328	2430	1905	2140
7/8-14	180	140	470	350	670	500	2318	2420	1895	2130
1-8	250	190	640	480	910	680	3440	3595	2815	3185
1-14	280	210	720	540	1020	760	3110	3250	2545	2885

HYDRAULIC FITTING TORQUE SPECIFICATIONS

Tapered Pipe Thread Size - Assembly turns from Finger Tight (TFFT) for Tapered Threads		TFFT
BSPT (Uncommon)	NPTF (Common)	
1/8-28	1/8-27	2 - 3
1/4-19	1/4-18	2 - 3
3/8-19	3/8-18	2 - 3
1/2-14	1/2-14	2 - 3
3/4-14	3/4-14	2 - 3
1-11	1-11 1/2	1.5 - 2.5
1 1/4-11	1 1/4-11 1/2	1.5 - 2.5
1 1/2-11	1 1/2-11 1/2	1.5 - 2.5
2-11	2-11 1/2	1.5 - 2.5



ORB - SAE J1926 Straight Thread Port Assembly Torques													
		Assembly Torque (+10% -0) **If fitting is being torqued into aluminum or brass, subtract 35% from standard torque value**											
		Non-Adjustable				Adjustable				Plugs			
		ORFS		JIC NPT		ORFS		JIC		Hollow Hex		Hex Head	
Dash Size	SAE Size (UN/UNF)	Ft. lbs. (In. lbs.)	Into Alum. Or Brass Ft. lbs. (in. lbs.)	Ft. lbs. (In. lbs.)	Into Alum. Or Brass Ft. lbs. (in. lbs.)	Ft. lbs. (In. lbs.)	Into Alum. Or Brass Ft. lbs. (in. lbs.)	Ft. lbs. (In. lbs.)	Into Alum. Or Brass Ft. lbs. (in. lbs.)	Ft. lbs. (In. lbs.)	Into Alum. Or Brass Ft. lbs. (in. lbs.)	Ft. lbs. (In. lbs.)	Into Alum. Or Brass Ft. lbs. (in. lbs.)
2	5/16-24	-	-	(85)	(55)	-	-	(60)	(39)	(30)	(19.5)	(85)	(55)
3	3/8-24	-	-	(155)	(101)	-	-	(100)	(65)	(55)	(36)	(155)	(101)
4	7/16-20	(310)	(201.5)	(260)	(169)	(180)	(117)	(180)	(117)	(120)	(78)	(260)	(169)
5	1/2-20	(360)	(234)	(280)	(182)	(360)	(234)	(250)	(162.5)	(170)	(110.5)	(280)	(182)
6	9/16-18	(420)	(283)	(350)	(227.5)	(420)	(273)	(350)	(227.5)	(410)	(266.5)	(350)	(175)
8	3/4-16	60	39	(620)	(403)	60	39	(620)	(217)	60	39	(620)	(403)
10	7/8-14	100	65	85	55	100	65	85	55.25	100	65	85	55
12	1 1/16-12	135	88	135	88	135	88	135	88	135	88	135	88
14	1 3/16-12	175	114	175	114	175	114	175	114	175	114	175	114
16	1 5/16-12	200	130	200	130	200	130	200	130	200	130	200	130
20	1 5/8-12	250	162.5	250	162.5	250	162.5	250	162.5	250	162.5	250	162.5
24	1 7/8-12	305	198	305	198	305	198	305	198	305	198	305	198
32	2 1/2-12	375	244	375	244	375	244	375	244	375	244	375	244

HYDRAULIC FITTING TORQUE SPECIFICATIONS

Code 61 and 62 Flange Recommended Bolt Torques

Steps to Properly Assemble the Flange Port Clamping Bolts:

1. Inspect components to ensure that male and female port threads and sealing surfaces are free of burrs, nicks and scratches, or any foreign material.
2. Lubricate the O-ring
3. Position flange and clamp halves
4. Place lock washers on bolts and insert through clamp halves
5. Hand tighten bolts.
6. Torque bolts in diagonal sequence in small increments to the appropriate torque level **refer to the table below.

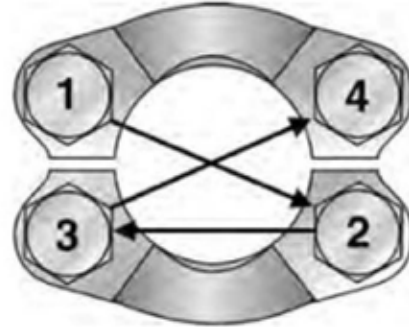

Flange Bolt Tightening Sequence

Code 61						Code 62					
Dash Size	Flange Size	Inch Bolt (SAE J518)	Torque ft. lbs.	Metric Bolt (ISO 6162)	Torque N-m	Dash Size	Flange Size	Inch Bolt (SAE J518)	Torque ft. lbs.	Metric Bolt (ISO 6162)	Torque N-m
8	1/2	5/16-18	17 ± 2	M8	24	8	1/2	5/16-18	17 ± 2	M8	24
12	3/4	3/8-16	31	M10	50	12	3/4	3/8-16	31	M10	50
16	1	3/8-16	31 ± 4.5	M10	50	16	1	7/16-14	52	M12	92
20	1-1/4	7/16-14	52	M12	50	20	1-1/4	1/2-13	77	M14	130
24	1-1/2	1/2-13	77	M12	92	24	1-1/2	5/8-11	155	M16	210
32	2	1/2-13	77	M12	92	32	2	3/4-10	265	M20	400
40	2-1/2	1/2-13	77	M12	92						
48	3	5/8-11	155	M16	210						
56	3-1/2	5/8-11	155	M16	210						
64	4	5/8-11	155	M16	210						
80	5	5/8-11	155	M16	210						

37° Flare (JIC) Assembly Torques and FFWR					
SAE Dash Size	Thread Size	Assembly Torque (+10%-0)		Tube Connection FFWR	Swivel Nut or Hose Connection FFWR
		In. lb.	ft. lb.		
-2	5/16-24	35	3	-	-
-3	3/8-24	65	5	-	-
-4	7/16-20	155	13	2 1/2	2
-5	1/2-20	165	14	2	2
-6	9/16-18	265	22	2	1 1/2
-8	3/4-16	505	42	2	1 1/2
-10	7/8-14	720	60	1 1/2	1 1/2
-12	1 1/16-12	1000	84	1 1/2	1 1/4
-14	1 3/16-12	1200	100	1 1/2	1 1/4
-16	1 5/16-12	1415	118	1 1/2	1
-20	1 5/8-12	2015	168	1	1
-24	1 7/8-12	2340	195	1	1
-32	2 1/2-12	3180	265	1	1
-40	3-12	-	-	1	1

SET-UP & ASSEMBLY



WARNING: Some photographs used in the following pages show guards or shields removed for clarification. Never operate machine until these guards or shields are in proper operating position.

NOTE: Determine right or left side of the Manure Spreader by viewing it from the rear. If instructions or parts lists call for hardened bolts, refer to the Cap Screw Torque Values page to identify.

WHEELS & TIRES

The **TOP SHOT** may be shipped without the wheels/tires installed.

1. Attach the wheels with tires using the lug nuts furnished and torque the mounting hardware to the appropriate torque listed in the Service Chapter. Check wheel bolts periodically thereafter.
2. Inflate the tires to the appropriate pressure listed in the Service Chapter.
3. Check the **TOP SHOT** for proper assembly and adjustment and make sure that all bolts are tightened.
4. Securely retighten after a few hours of operation, as bolts can loosen up on new machinery.
5. Lubricate the **TOP SHOT** completely.

TRANSPORTING

TRANSPORT LIGHTING & REFLECTORS

Transport lighting with a 7-pin plug is standard equipment on all **TOP SHOT** Models. The lighting system is to be connected to the 7-pin power receptacle (per SAEJ560B) on your tractor. If your tractor is not equipped with the proper receptacle, see your tractor dealer for details. Red reflective safety decals and a SMV sign are on the rear of the tank for safety.

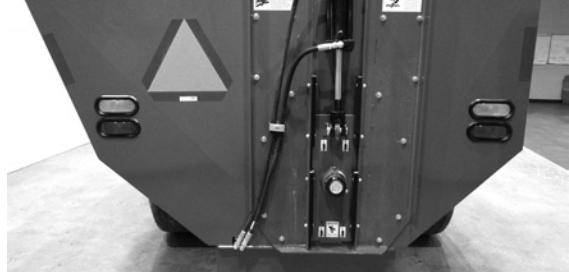

SAFETY CHAIN (Optional)

Follow state and local regulations regarding use of a safety chain and transport lighting when towing farm equipment on public highways. A proper safety chain should be used to retain the safety connection between the towing and towed machines, in the event of separation of the primary attaching system. Check with local law enforcement agencies for your own particular regulations. Unless otherwise prohibited, use a slow-moving vehicle emblem. Never tow the **TOP SHOT** on a public highway at a speed greater than 20 mph (32 kph).

As required or when desired, the **TOP SHOT** can be equipped with a safety chain for travel on public highways.

1. Chain is sufficiently slack to allow turns and movements of either the tractor or the **TOP SHOT**, without placing tension on the chain.
2. Chain is of sufficient strength to hold the decoupled implement (and its load) and tow it to the shoulder.

TOWING ON HIGHWAY

To view beyond the back of the larger trailer-mounted **TOP SHOT** when transporting the unit on a public highway, consider obtaining and installing a rearview mirror on your tractor with a wide load mounting bracket.

STORAGE

Because the **TOP SHOT** is likely to be used year-round, it should be in ready-to-operate condition at all times. Several provisions have been designed into the **TOP SHOT** to enable it to be used in cold, moderate, and warm outside temperatures. The most important factor for continuous proper operation is lubrication. When operating the **TOP SHOT** in freezing temperatures, the unit should be stored inside, if possible. Refer to Operation Chapter for special operating procedures in freezing temperatures.

PREPARING FOR OPERATION

PREPARING TOP SHOT

Properly lubricate the **TOP SHOT**, check automatic oiler level, and fill if necessary before operating. Refer to Lubrication Section of this Operator's Manual for locations.

If the **TOP SHOT** is going to be operated in freezing temperatures, review and comply with recommendations in the Operation Chapter under the Winter Operation section.

Proper operation of a loaded **TOP SHOT** requires a tractor with sufficient horsepower to run the PTO and proper size to counterbalance the weight of a loaded **TOP SHOT**.

TRACTION CONNECTIONS

Tractor Hitch

1. The hitch of the **TOP SHOT** is designed for a standardized tractor hitch. Adjust the drawbar so that it is 13 to 17 inches above the ground.
2. Extend or shorten it so that the horizontal distance from the end of the tractor power takeoff shaft to the center of the hitch pin hole is 15-3/4" for 1000 RPM PTO as shown in drawing. An improperly located hitch point may cause damage to the universal joints of the power takeoff.
3. Secure the drawbar so that the hitch pin hole is directly below the power drive line. Fasten the **TOP SHOT** to the tractor drawbar with an appropriate hitch pin with safety locking device. After the connection is made, remove the hitch jack and secure it to the "Storage Position" on the left side of the Spreader.

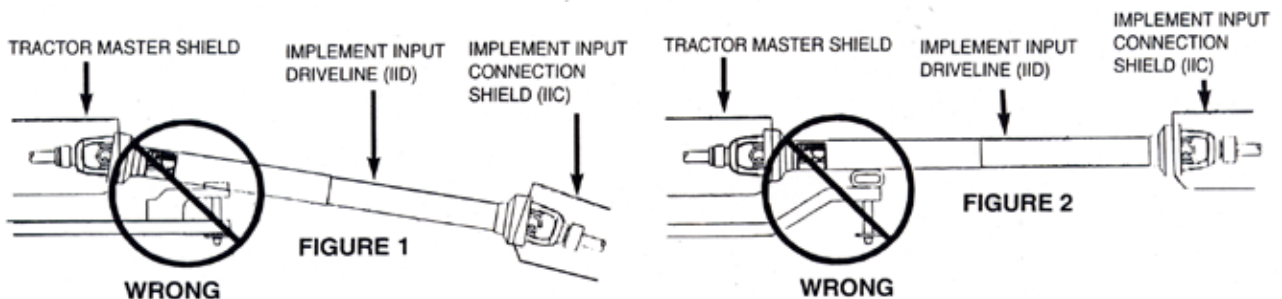
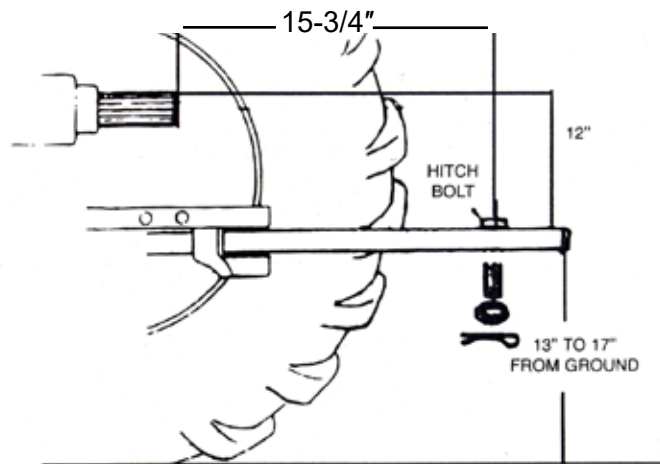

If the **TOP SHOT** is attached to a tractor with a clevis hitch (hammer-strap) style drawbar, the hammer-strap must be removed to prevent damage to the IID guarding and the IID telescoping members. [See Figure 1]

If the **TOP SHOT** is attached to a tractor with an offset in the drawbar, be certain it is in the down position to prevent damage to the IID guarding and the IID telescoping members. [See Figure 2]

PREPARING FOR OPERATION

PTO

The **TOP SHOT** is equipped with a constant velocity telescoping PTO drive shaft. This constant velocity capability results in a smooth, quiet running drive line without power fluctuation. The **TOP SHOT** can only be properly hooked-up to a tractor which has PTO and hitch dimensions conforming to ASAE Standard S203. Horsepower required may vary according to the consistency of material to be spread, ground speed, and terrain. To prevent damage to the telescoping PTO drive, DO NOT allow the tractor's rear tires to make contact with the PTO or **TOP SHOT** while making sharp turns. Be careful when pulling the **TOP SHOT** with a tractor that is equipped with dual rear tires.

NOTE: *The maximum joint angle must not exceed 80° whether in operation or not. Any angle greater than 80°, will result in damage to the joint. For continuous operation, the maximum joint angle must be limited to 35°. Any continuous operation at angles greater than 35° will shorten joint life.*

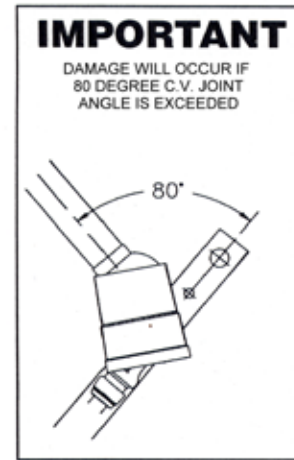

Attach the **TOP SHOT** PTO to the tractor PTO shaft locking it into position and check distance by the following:

1. Maintain a straight alignment between the **TOP SHOT** and the tractor.
2. Maintain a distance of 6"- 12" between the top of the tractor drawbar and the center of the tractor PTO. An 8" distance is standard.

After the correct distance is obtained, slide back the coupler lock and attach the PTO drive to the tractor PTO shaft. Make sure that the coupler locks onto the PTO shaft; slide it back and forth until it locks.

NOTE: *Do NOT attempt to use a hammer to help in attaching the PTO drive connection.*

NOTE: *Remove the tractor 3-point quick hitch if the tractor is equipped with one. Tractor 3-point arms must be removed or positioned so they do not come in contact with the **TOP SHOT** tongue or PTO. Failure to heed will cause damage and void the warranty.*

Hydraulics

The **TOP SHOT** requires a 6-hose hook-up:
- 2 hoses for raising/lowering the main auger.
- 2 hoses for opening/closing the discharge door.
- 2 hoses for operating the discharge deflector.

Optional:

- 2 hoses for the optional lid.

Before starting the tractor, make sure each set of hydraulic hoses connects to the appropriate set of remote outlets on the tractor. Operate the tractor valve to fill the hydraulic lines and operate the cylinders. Add hydraulic fluid to the tractor system, as required.



OPERATION

EMERGENCY SHUTDOWN

In case a foreign object becomes lodged in the expeller or auger area, disengage the PTO. Stop the tractor engine, remove ignition key, and allow all mechanisms to stop before cleaning or working on the machine. If an object is lodged inside the tank, block-up the discharge gate and raise the conveyor auger before attempting to remove the object.

GENERAL INFORMATION

Check entire **TOP SHOT** carefully before first operation. Tighten bolts and set screws that might have come loose in shipping. Lubricate as explained in the Lubrication Chapter in this manual.

H&S **TOP SHOTS** feature a large tank, forward right side discharge expeller, hydraulically controlled discharge gate, and conveyor auger. **TOP SHOTS** are designed and constructed to handle a wide variety of waste material types including liquids, semi-liquids, and limited solid material. Many potential spreading problems can be avoided if the following guidelines are established and met:

NOTE: *To prevent damage to the expeller, auger, and drive line, foreign objects such as stones, timber, or metal should never be placed into the **TOP SHOT** tank.*

1. In winter or freezing temperatures, make sure the auger and expeller are free to rotate and that the discharge gate moves freely before loading the **TOP SHOT** and applying PTO power.
2. The discharge gate must be closed before loading.
3. The auger is completely lowered before loading.
4. When loading packed material into the **TOP SHOT** with a loader bucket, try to break up any large chunks.
5. Material which is too thick or solid to flow should only be heaped on the rear 2/3 of the **TOP SHOT**.
6. When hauling extremely heavy materials with a large portion of dirt, it may be necessary to reduce the load size to prevent excessive shear bolt breakage. Do not use extra sideboards. Do not overload the **TOP SHOT**. Overloading decreases spreading effectiveness.
7. Liquid or semi-liquids that flow will self-level, allowing the **TOP SHOT** to be filled to a level such that sloshing or splashing material will be contained.

NOTE: *Expeller feeding will diminish as bridging occurs. To counteract bridging, completely raise, and lower the auger back down immediately. This operation will help to break-up the bridging.*

OPERATION

APPLICATION RATE

The side discharge style **TOP SHOT** features a hydraulically operated discharge gate to control the material flow out of the tank and into the expeller. Several factors influence the rate of discharge and the spread pattern. These factors include: ground speed, type or consistency of discharge material, PTO RPM, and discharge gate opening. Depending on your application requirements and the type of material being spread, a full range of patterns can be obtained. A discharge gate indicator provides a continuous visual display of the gate opening.

FIELD OPERATION

The **TOP SHOT** is "direct drive" which begins to operate immediately when the PTO is engaged. Drive disengagement is made by shutting-off the tractor PTO. It is important that the PTO is engaged at low tractor RPM. Torque limiting overload protection on the PTO is provided for both the main auger and the expeller. For proper operation, establish and maintain the proper driveline alignment and tractor hookup. Before loading material, adjust the hitch clevis to your tractor in order to obtain a level or forward attitude of the **TOP SHOT** tank. Refer to the Preparing For Operation Chapter for additional details.

If the **TOP SHOT** is going to be operated in freezing temperatures, review and comply with recommendations in Winter Operation.

WINTER OPERATION

When loading and spreading material during winter or in freezing temperatures, the following recommendations apply:

1. After the **TOP SHOT** is unloaded and will not be used for some time, follow the EMERGENCY SHUTDOWN PROCEDURE, then scrape away any solid material remaining on the inside of the tank or Expeller area.
2. Park the **TOP SHOT** with the auger fully raised, the discharge gate fully raised and blocked. Position the jack height so that liquids will run forward to the discharge opening.
3. Before loading the **TOP SHOT** again, unblock the discharge gate and engage the expeller to make sure that it is free to rotate. Then, slowly lower the auger to the bottom of the tank and cycle the discharge gate a few times.

NOTE: To eliminate freeze-up in the area under the expeller, open the expeller pan by pushing the trip handle forward, the pan will release. Before resuming operation, close the pan.

NOTE: The pan can be removed after release of the trip handle by lifting it out of the U-Shaped slots on each side of the pan if freeze-up problems persist in this area.



OPERATION

UNLOADING & SPREADING

Packed Material

To unload and spread packed material and prevent unnecessary stress on the drive line components, observe the following guidelines:

1. Make sure the auger is completely lowered.
2. Engage the tractor PTO at as low an RPM as possible. Then, slowly bring the PTO up to the rated RPM.
3. Raise the discharge gate until it is about 1/3 open.
4. Select the desired tractor gear and begin spreading. To achieve the desired coverage, adjust the discharge gate and/or travel speed.
5. When spreading material which is susceptible to bridging, the auger should be cycled up and down, frequently, to provide a more consistent feeding of material into the expeller.

NOTE: Do NOT exceed the 1000 RPM operating speed.

OVERLOAD PROTECTION

The **TOP SHOT** is equipped with a Torque Limiting / Overrunning Clutch. If the torque limiter releases, stop all operation and follow the EMERGENCY SHUTDOWN PROCEDURE.

The following are probable causes for torque limiting clutch disengagement:

1. A foreign object is present in the expeller.
2. Overfeeding of the expeller due to improper discharge gate adjustment.
3. Gate is being raised when spreading liquid material before expeller is up to operating speed.

OPERATION

DRIVE CHAIN TOLERANCES

Drive chains must be kept in adjustment within the following tolerances:

Jackshaft Chain Spring Length - 9 ¾" to 10 ¼"

Auger Chain Spring Length - 13 ½" to 14"

Expeller Drive Chain Deflection - 1/2" to 3/4"

AUGER & EXPELLER SPEED OPTIONS

TOP SHOTS are factory equipped with drive components selected to provide the best possible performance for processing basic material and manure types available. In certain materials, conveying and spreading performance can be improved by altering the speeds of the auger, the expeller, or both.

ADJUSTABLE EXPELLER SHIELD

The **TOP SHOT** features a hydraulic adjust expeller deflector shield to direct material and provide the best possible performance for delivery of material. The deflector shield requires (1) set of tractor remotes to operate.



OPERATION

CONTROLS & SAFETY EQUIPMENT

TOP SHOTS are provided with several features for operator safety and convenience.

Guards & Shields

Whenever possible and without affecting the operation of the *TOP SHOT*, guards, shields and/or hinged shields have been used on this equipment to protect potentially hazardous areas. In many places, decals are also provided to warn of potential dangers as well as to display special operation procedures.



Auger Control

TOP SHOTS have a hydraulically controlled raise/lower main auger to overcome material bridging when unloading hard-packed waste material. The auger can be hydraulically raised from the tractor seat as necessary. An auger height indicator, visible from the tractor seat, allows the operator to monitor the auger height. When the unit is parked overnight in freezing temperatures, raise the main auger to prevent the auger from freezing against the bottom of the tank.



Discharge Gate Control

The *TOP SHOT* has a hydraulically controlled discharge gate with indicator to regulate the amount of material being discharged. In freezing temperatures, leave the discharge gate partially opened when the unit is parked overnight to prevent the gate from freezing against the bottom of the opening. A discharge gate height indicator visible from the tractor seat allows the operator to monitor the gate opening.

OPERATION

Jack

A jack is furnished with the **TOP SHOT** to support the machine when the tractor is disconnected and to adjust the hitch clevis to the tractor drawbar for hookup. The jack should never be used to support a loaded **TOP SHOT**.



When the jack is not being used to support the **TOP SHOT**, it should be relocated to the "storage" position located on the left side of the **TOP SHOT** as shown.



Safety Chain

As required or when desired, the **TOP SHOT** should be equipped with a safety chain for transporting the unit on a public highway. Refer to the Transport Chapter for details.

Telescoping PTO Drive

The telescoping PTO drive is designed to rotate freely inside the drive shield tubes and is provided with a spring-loaded locking collar on one end to positively lock the drive connection onto the tractor PTO shaft. Depress the locking collar, against the spring tension, and slide the yoke onto tractor PTO shaft. Release the locking collar and move the yoke ahead or back until the lock engages into the groove on the shaft.

NOTE: *When the spreader is not attached to the tractor, the PTO Drive can be conveniently supported by the chain provided as shown. This position is used only when the **TOP SHOT** is NOT in operation. Never transport the **TOP SHOT** with the PTO in this position.*



TRANSPORT LIGHTING

Connect the transport lighting cord that is standard equipment on all **TOP SHOT** models to the lighting system 7 pin power receptacle (per SAEJ560B) on your tractor. If your tractor is not equipped with the proper receptacle, see your tractor dealer for details.



ADJUSTMENTS

DRIVE CHAIN IDLERS

Expeller Drive Chain Idler

The expeller drive chain is tensioned with an adjustable sprocket idler. The chain is properly tensioned when the chain can be deflected 1/2" to 3/4" (13 to 19 mm) with hand pressure.

NOTE: *If an idler fails to maintain proper tension, replace the worn chain.*

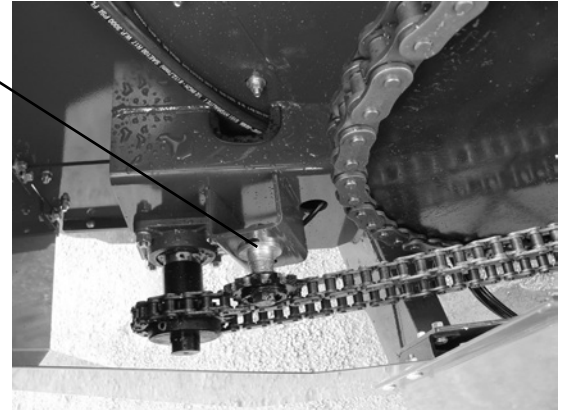

Shield open for viewing

Auger Drive Chain Idlers

The jackshaft and auger drive chain tighteners are spring loaded.

Use the eye bolt adjustment to achieve a spring length of 9 3/4" to 10 1/4" on the initial reduction auger drive chain.

The auger final drive chain tension device uses an eye bolt, and S-hook to accomplish adjustment. With the auger in its lowest position, use the eye bolt to achieve a spring length of 13 1/2" to 14" on the final drive chain for obtaining the specified tension.

NOTE: *If an idler fails to maintain proper tension, replace the worn chain.*

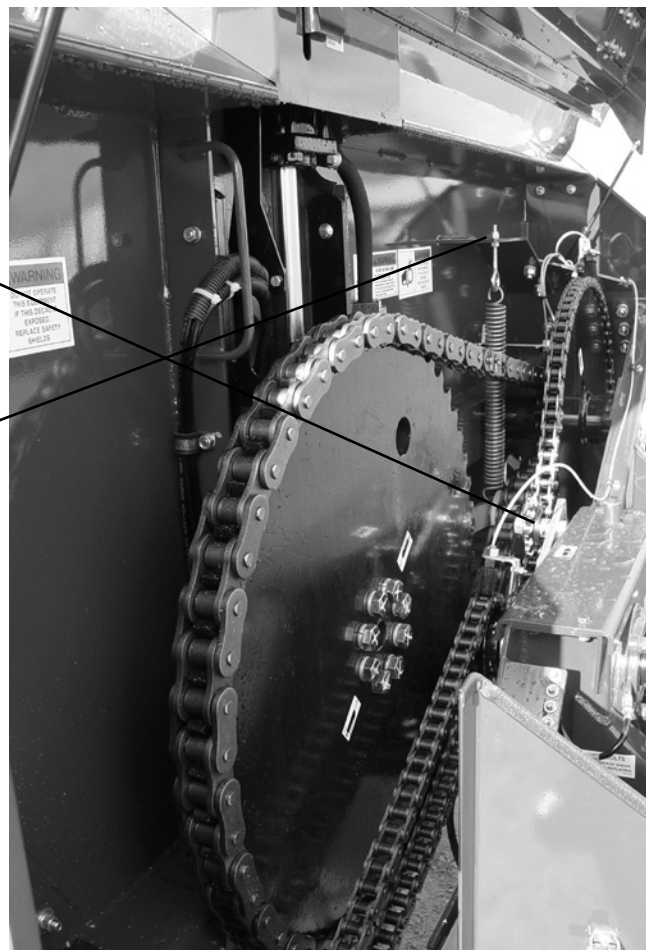

Shield open for viewing

ADJUSTMENTS

FRONT & REAR AUGER SLIDES

The front and rear auger slide assemblies are retained by adjustment plates with diagonal slots. To adjust, loosen retaining hardware and drive the plates downward with a hammer until the slide assembly is snug against the tank, then retighten the retaining hardware. Grease the slide assembly to ensure a leak-free seal.



DISCHARGE GATE

The discharge gate is retained by adjustable angles that secure the gate to the tank through diagonal slots. To adjust, loosen retaining hardware and drive the angles downward with a hammer until the discharge gate is snug against the tank, then retighten the retaining hardware. Grease the discharge gate to ensure a leak-free seal.



SERVICE

EXPELLER

Periodically inspect the expeller teeth for wear or damage. Damaged, broken, or missing expeller teeth will cause excessive machine vibration. Consult with your local H&S dealer for additional ordering information.

AUGER & EXPELLER SPEED OPTIONS

The expeller input drive sprocket can be changed by raising the auger and then removing the indicated sprocket which is retained by a snap ring and set screws.

The auger input drive sprocket change requires removal and disassembly of input shaft.

NOTE: *When making sprocket changes, some chain length modifications may be required depending on the condition of the chain and size of the sprocket installed.*

OVERLOAD PROTECTION

When the torque limiting clutch disengages, stop all operation and follow the EMERGENCY SHUTDOWN PROCEDURE and proceed as follows:

1. Disengage the PTO.
2. If an object is lodged in the discharge door opening or inside the tank, raise the discharge door, then raise the main auger.
3. Shut off tractor and remove key.
4. Trip the expeller pan to clear any material or objects.
5. Remove any foreign objects from the discharge door opening or inside the tank
6. Close the main shield and resume operation.

IMPORTANT: *When resuming operation, place the tractor throttle at idle before engaging the PTO.*

SERVICE

TIRES & WHEELS

Check the tire pressure after every 10 hours of operation. Tires should be inflated to the appropriate pressure listed in the table.

<u>Tire</u>	<u>Pressure</u>
21.5L x 16.1 – 18 Ply	44
445/65R22.5	85
49x19x20	80
700/50x22.5	41

Wheel lug torque should be checked after every 50 hours of operation and tightened to the appropriate torque.

Wheel bolts must be tightened between 375-425 ft/lbs of torque.

WHEEL BEARING LUBRICATION, CLEAN & RE-PACK INSTRUCTIONS

Grease wheel bearings as needed depending on amount of travel.

Annually disassemble and clean parts in a solvent. Pack bearings with a high grade grease. Reassemble, and tighten nut until a slight drag is felt when wheel is turned. Back nut off and insert cotter pin into first hole that you see as you back the nut off, bend cotter pin over and reinstall cap.

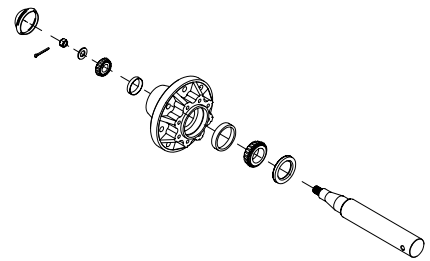

FOLLOW THE INSTRUCTIONS ABOVE FOR GREASEABLE HUBS, AND BELOW FOR OIL BATH HUBS!

WHEEL HUB - OIL BATH

OIL ASSEMBLY - DO NOT GREASE!

Follow the steps below when installing a new seal or adjusting the hub tightness.

1. Wipe the rubber seal with oil before installing.
2. Assemble as shown in the picture.
3. Torque the spindle nut to 110 ft. lbs. while rotating the hub to seat in the bearing assembly.
4. Loosen the spindle nut and re-torque to 70 ft. lbs. while rotating the hub.
5. Loosen the spindle nut to no more than 30 degrees to install the spring pin.
6. With the hub horizontal, remove the plastic cap and fill the hub cavity to the fill line with Casrtol Hyspin VG46 hydraulic oil. Replace the plastic cap.

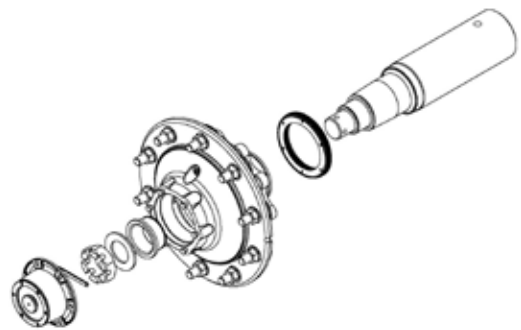

OPTIONAL EQUIPMENT

NOTE: The optional features & accessories listed in this chapter are shipped with separate instruction for installation, as applicable.

AUGER SPEED OPTIONS

Several different drive sprockets are available to change auger speeds to various spreading needs. Sprockets are available as service parts.

EXPELLER SPEED OPTIONS

Several different drive sprockets are available to change expeller speeds to various spreading needs. Sprockets are available as service parts.

SAFETY CHAINS

An appropriate-sized safety chain to accommodate the potential weight of the loaded **TOP SHOT** is available.

ELECTRONIC SCALES & COMPONENTS

Model: Digi-Star GT400

An optional factory installed Digi-Star GT400 scale is available for accurate weight measurement for each load spread. The 5-point weighbar system features 3 modes: Net, Tare and Gross.

Model: Digi-Star NT460

An optional factory installed Digi-Star NT460 scale system is available for accurate weight measurement and displaying actual tons per acre. The Indicator has GPS capability and stores pounds of manure spread on individual fields.



DISCHARGE DEFLECTOR ELECTRIC VALVE

An electric valve for the discharge deflector hydraulic cylinder is available as an option if there are not 3 remotes available on the tractor. This valve is combined with the discharge door hydraulic circuit and operated with a switch to change operation between the 2 operations.

HYDRAULIC OPENING/LOCKING LID

The optional Hydraulic Opening Lid can be installed on the 5242. The lid can be installed as right or left side opening. A third tractor remote is needed to open and close the lid. After the lid is hydraulically closed, activate the electrical toggle switch with the remote lever activated to hydraulically rotate the lock clamp bar over the 4 pins.

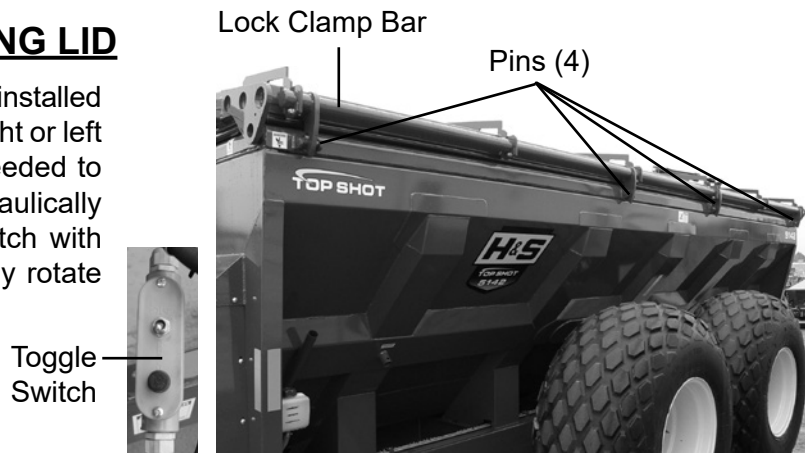

LUBRICATION

GREASING

There are numerous grease fittings on the **TOP SHOT** that must be lubricated properly and often with a high-quality grease. Replace any missing or plugged grease fittings. Become familiar with all lubrication points and establish a routine to ensure complete lubrication of the **TOP SHOT**.

Wipe dirt from the fittings before greasing to prevent the dirt from being forced into the bearing or pivot. Grease should come out around the shaft on sleeve type bearings. On the sealed ball bearings, grease should be added slowly until a slight bead forms at the seal indicating the correct amount of lubricant. To minimize dirt build-up, avoid excessive greasing. After greasing, wipe off the excess grease from around the outside of the bearings to prevent the accumulation of chaff and grit.

*NOTE: Grease all fittings at the intervals of operation listed before and after storing the **TOP SHOT**. Use a good grade of Lithium-base grease.*

GENERAL INFORMATION

IMPORTANT: *Catch and dispose of fluid per local waste disposal regulations whenever service is performed on hydraulic components, valves, cylinders, hoses, etc.*

PTO ASSEMBLY

Keep the male and female shafts of the PTO well-lubricated and free-sliding. Failure to observe this precaution will result in excessive pressure being required to collapse or extend the assembly while subject to operating torque. This excessive force may damage the main shaft bearings. Never lubricate the shield surfaces. The shield surfaces must be kept dry, as dirt accumulation on them will cause the shields to bind and not rotate. Dented or damaged PTO shields will also result in excessive force being applied against the jackshaft. Damaged shields also cause difficulty when installing the assembly. If at any time the shields do not turn freely, they should be checked to determine the cause, and repaired or cleaned. To avoid damage to the main drive bearings, avoid turning sharp corners while PTO is running. Start and Stop PTO slowly to avoid damage to the drive line.

GEAR BOX

To check the oil level on the gear box, remove the CHECK LEVEL PLUG on the back side of the gear box to see if the oil level is at the bottom of the hole. If oil is needed to bring the oil level to the check level, remove the VENT FILL PLUG to add 80W-90 oil.

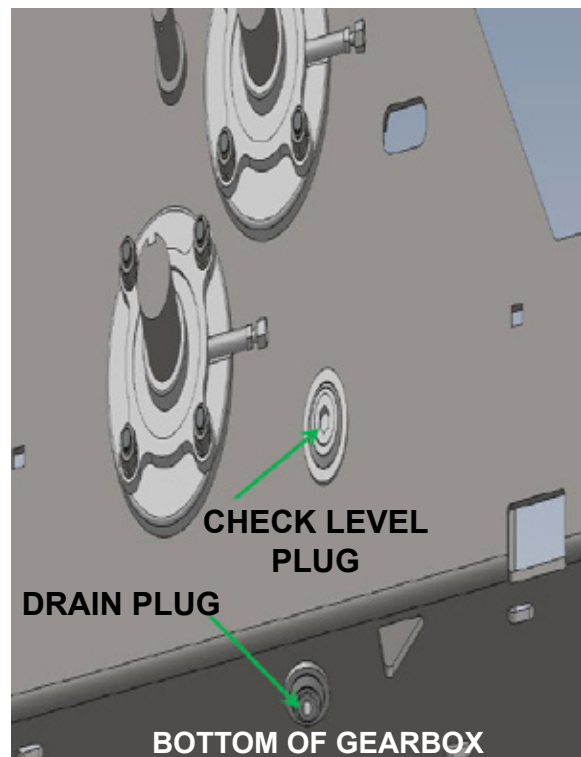
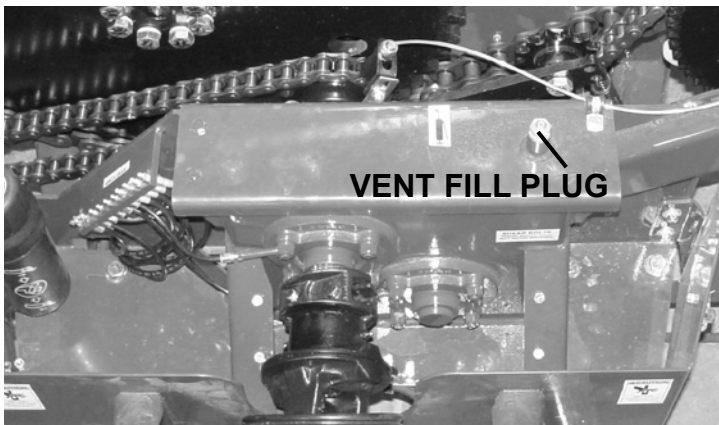

LUBRICATION

DRIVE CHAINS

The drive chains are lubricated by a automatic chain oiler using 10W-30 oil. Any time that the discharge door is raised, a specified amount of oil is sent to the brushes on each of the chains. The oiler is adjustable to set the amount that is being discharged. This will extend the life of the drive chains. Keeping the chains aligned with sprockets will also lengthen the life of the sprockets and drive chains.

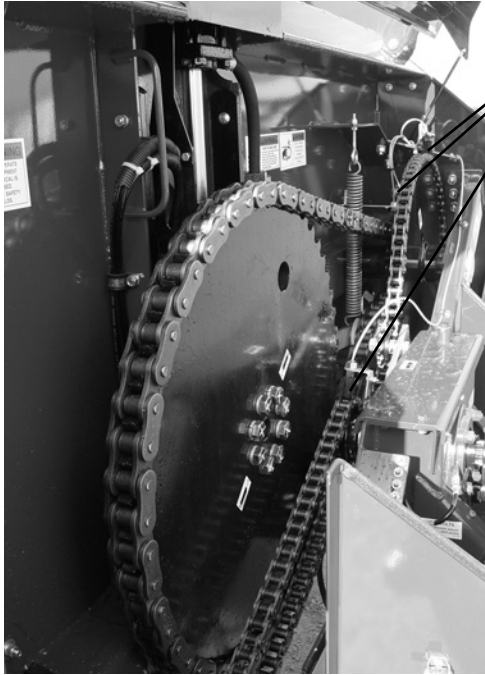

Oiler brushes on all chains.



The oiler reservoir is located on the left front side by the scraper holder and jack storage position.

CYLINDERS

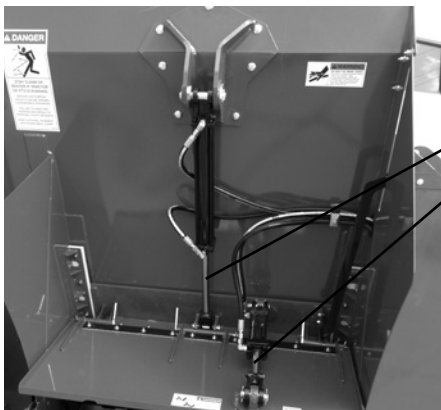

The discharge gate control cylinder shaft, discharge door deflector shield cylinder shaft and both front and rear main auger cylinders should also be frequently coated with a rust preventative spray or lubricate since the cylinder shaft may remain extended when not being used for a period of time.



LUBRICATION

Grease Fitting Locations - Grease Every 10 Hours (or Daily)

1. Main Auger Thrust Washer
2. Main Auger Front Bearing
3. Front Auger Slide Plate (4 Remote Zerks)
4. Auger Jackshaft (Zerk in Sprocket Hole)
5. 2 Idler Arms (1 Zerk on each)
6. Gearbox Bearings (4 Remote Zerks)
7. Front Expeller Bearing (1 Remote Zerk)

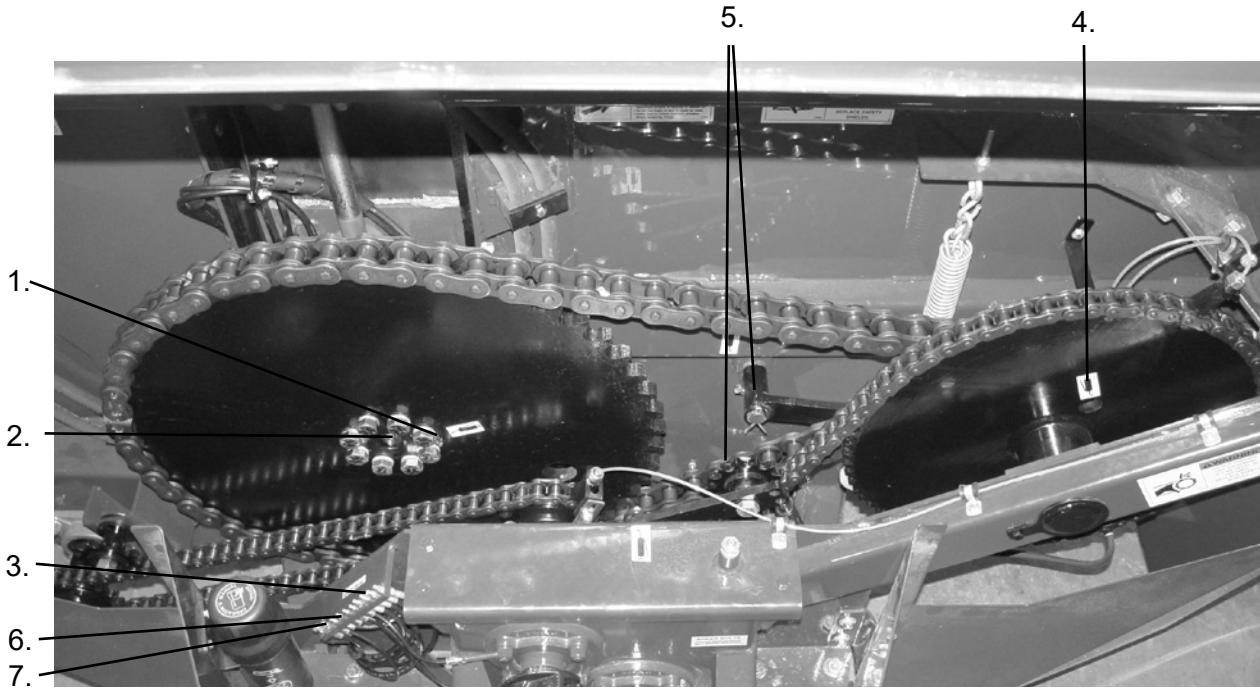

LUBRICATION

Grease Fitting Locations - Grease Every 10 Hours (or Daily)

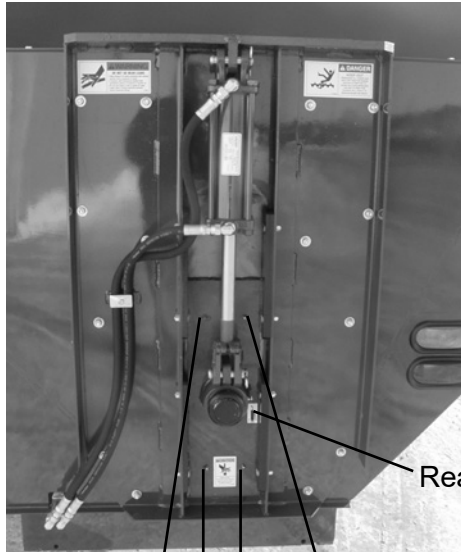

Rear Auger Slide Plate (4 Zerks)

Rear Auger Bearing

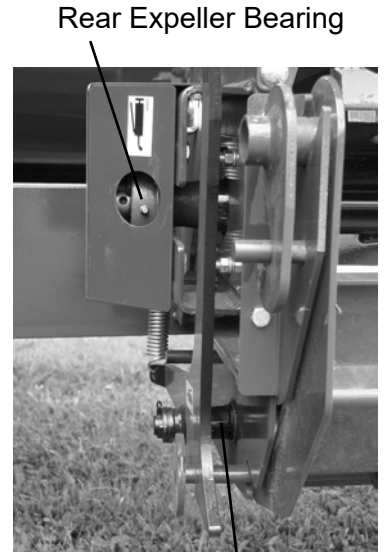

Expeller Pan Release Pivot

WHEEL BEARING LUBRICATION - GREASEABLE HUBS

Grease wheel bearings on the hub zerk as needed depending on amount of travel.

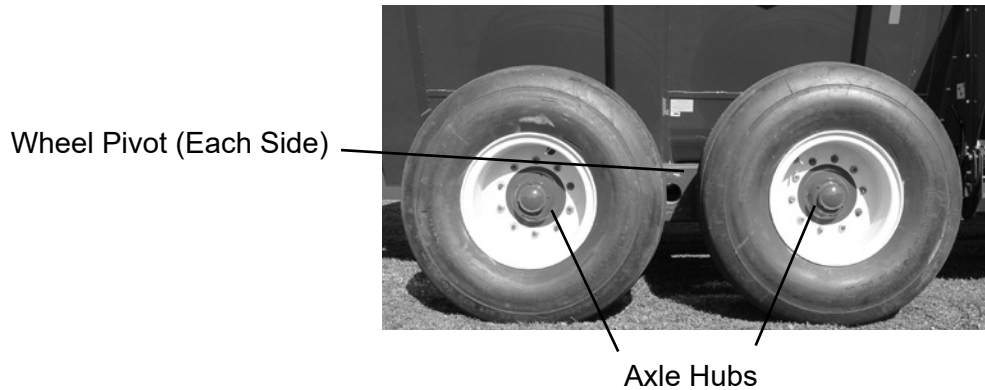

FOLLOW THE INSTRUCTIONS ABOVE FOR GREASEABLE HUBS, AND BELOW FOR OIL BATH HUBS!

WHEEL HUBS - OIL BATH

With the hub horizontal, remove the plastic cap and fill the hub cavity to the fill line with Casrtol Hyspin VG46 hydraulic oil. Replace the plastic cap.



DECAL LOCATION

Your H&S **TOP SHOT** was manufactured with operator safety in mind. Located on the **TOP SHOT** are various decals to aid in operation, and to warn of danger or caution areas. Pay close attention to all the decals on your **TOP SHOT**.



DO NOT REMOVE ANY OF THESE DECALS. IF DECALS ARE LOST, DAMAGED, OR IF YOUR TOP SHOT IS REPAINTED, REPLACE DECALS. REMEMBER: DECALS ARE FOR YOUR PROTECTION AND SAFETY.

Listed below are the decals on your **TOP SHOT**. These decals may be ordered individually by part number, or by ordering as a complete set.

<u>Part #</u>	<u>Quantity</u>	<u>Description</u>
311	1	Patent Decal
1494A	3	Do not operate this machine if this decal is exposed. Replace safety shields
1494B	2	Do not remove shields - moving parts inside
1494J	1	Do not clean or work on the machine without first disengaging power
1494L	1	Rotating driveline
3494A	1	Remote Grease Decal
5896B	3	Rotating driveline
8515	1	Degree of Angle Decal-PTO Shaft
9194A	4	No step - stay clear
9194B	1	Never Allow Riders on this Machine
11210A	1	Discharge gate opening decal
11210B	1	Do not remove shields
11599	5	Do not go near leaks
32320	1	Spiral Decal for Main Auger Shaft-Rear
51010	4	Pinch Point
54033	1	Made in USA 3"
66076	1	Located Behind Shield
71064	2	H&S/ Right and Left/ Side Badge Decal
71071	2	H&S/ TOP SHOT /Model # Decal-Side
71088	1	H&S/ TOP SHOT /Model Decal
71092	1	Model # Decal Front
71094	1	H&S/ TOP SHOT /Front Decal
71188B	1	Jack Storage Position
72203A	1	Help avoid injury - Read and understand the operators manual
82602	2	Crushing Hazard
84044	1	FEMA Decal
84045	1	H&S - Since 1967
86060	2	Stay Clear of Beater
022310	2	Attention - Wheel Torque
081312	1	Located behind sprocket
093020	17	Grease zerk decal
093366	1	Operators Manual
102196	1	Lube-CV Joint
111209A	2	Pinch Point
111209B	3	Stay clear of expeller when rotating or if tractor is running
111209C	4	Keep Out - Disengage all power and shut off tractor engine
11211176	2	Shear Bolts - Remove broken shear bolt before replacing
DCAMB	8	Amber Reflector
DCRED	3	Red Reflector
LW112901	1	Auger Height Indicator Decal
TFM97	1	SMV Decal

DECAL LOCATION



DECAL LOCATION

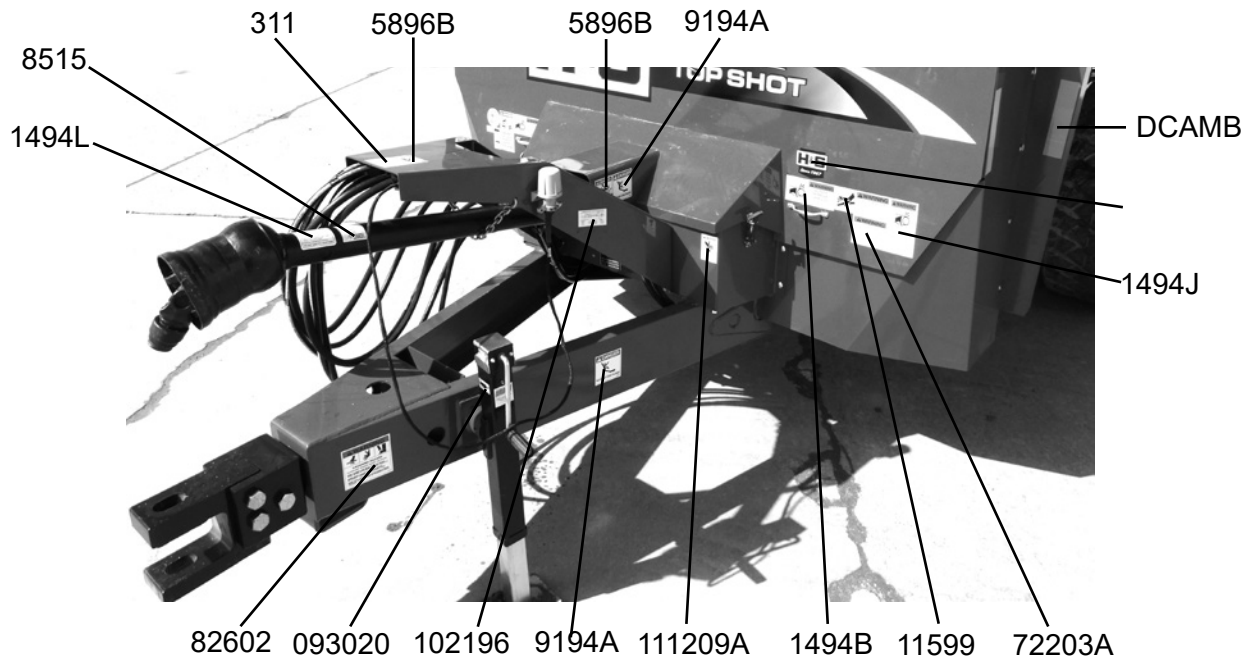
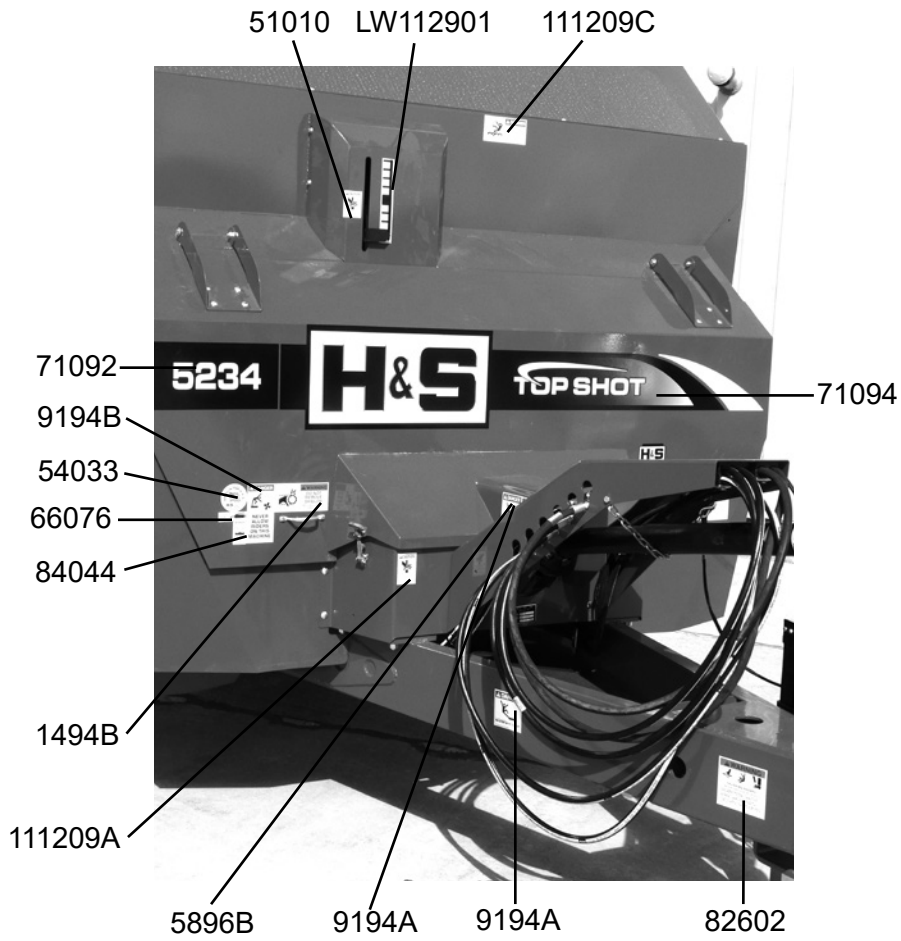

DECAL LOCATION

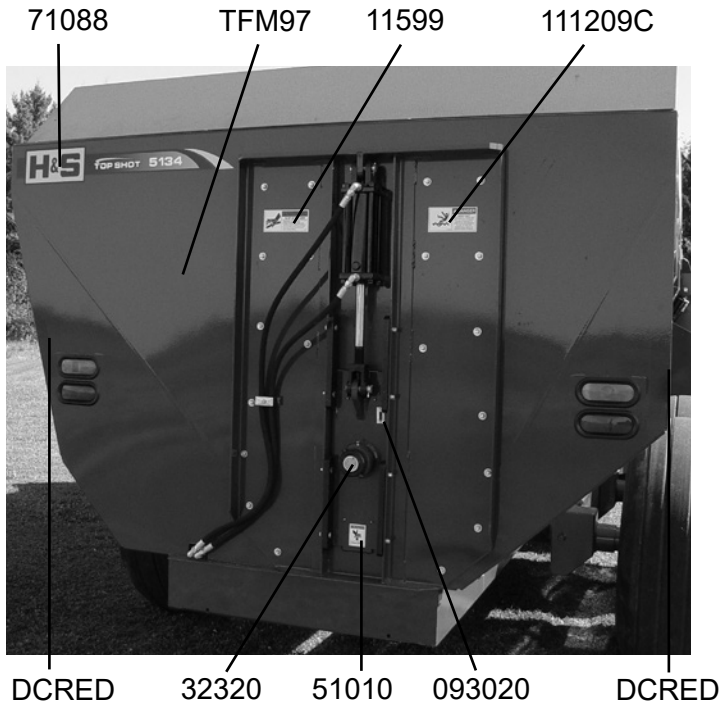
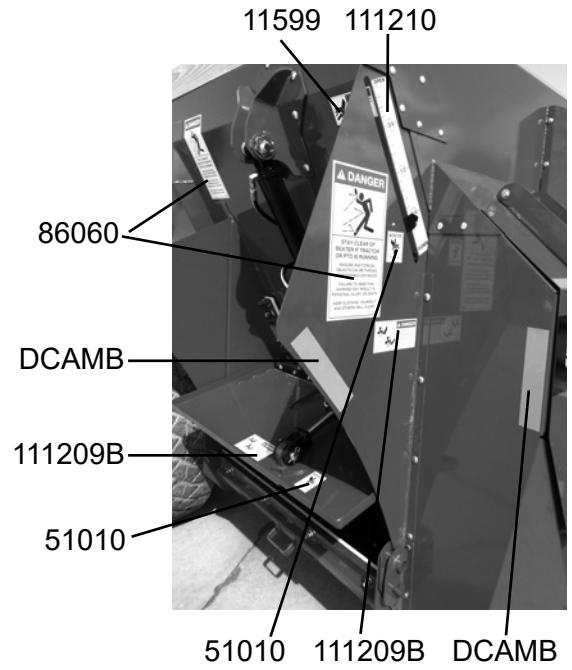
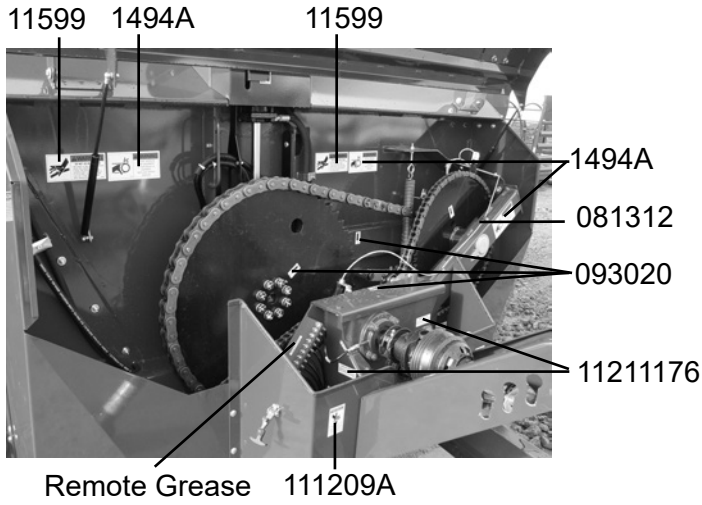

TROUBLESHOOTING

NOTE: This *Troubleshooting Chapter* presents problems, causes and suggested remedies beyond the extent of loose, worn or missing parts and it was developed with the understanding that the machine is in otherwise good operating condition.

1. Material NOT discharging from the expeller.	<ul style="list-style-type: none"> • Discharge gate is NOT open. • Expeller is not operating. • Expeller is obstructed. • Auger is NOT turning. 	<ul style="list-style-type: none"> • Open gate. • See item #3. • Activate gate to free obstruction. • See item #2.
2. Chains are jumping drive sprocket teeth.	<ul style="list-style-type: none"> • Inadequate chain tension • Sprocket teeth or chains excessively worn. 	<ul style="list-style-type: none"> • Adjust chain tension. See details in Adjustments Chapter. • Replace sprocket or chain.
3. Excessive chain and/or sprocket wear.	<ul style="list-style-type: none"> • Sprockets are NOT properly aligned. • Inadequate chain tension. 	<ul style="list-style-type: none"> • Re-align sprockets. • See item #6.
4. Drive chain(s) will NOT stay properly tensioned.	<ul style="list-style-type: none"> • Tensioner spring(s) NOT properly adjusted. • Idler pivot arm(s) binding. • Tensioner spring(s) broken or stretched. 	<ul style="list-style-type: none"> • Adjust tensioner spring(s). • Lubricate idler arm(s) to pivot freely. • Replace spring(s).
5. Uniformity of spread or discharge rate not acceptable.	<ul style="list-style-type: none"> • Difficult to spread material. 	<ul style="list-style-type: none"> • Change expeller or auger speed sprockets.
6. Auger will not turn.	<ul style="list-style-type: none"> • Drive chain not on sprocket. 	<ul style="list-style-type: none"> • Reinstall/replace chain. Sprockets MUST be properly aligned.
7. Expeller not turning	<ul style="list-style-type: none"> • Drive chain not on sprocket. 	<ul style="list-style-type: none"> • Reinstall/replace chain. Sprockets MUST be properly aligned.

H&S MFG. CO.

products approved

for the

FEMA SEAL OF QUALITY



Manufactured By:

H&S MANUFACTURING CO., INC.

2608 S. HUME AVE. MARSHFIELD, WI 54449

(715) 387-3414 | hsmfgco.com

